

**TSPL/TSPL2 Programming Language**

**TSC BAR CODE PRINTER SERIES**

**PROGRAMMING MANUAL**



# TABLE OF CONTENTS

|   |           |
|---|-----------|
| How to Read.....  | VI        |
| Document Conventions.....                                 | VII       |
| Object Position Calculation .....                         | VIII      |
| Printer Model List.....                                   | X         |
| <b>Setup and System Commands .....</b>                    | <b>1</b>  |
| <input type="checkbox"/> SIZE.....                        | 1         |
| <input type="checkbox"/> GAP .....                        | 2         |
| <input type="checkbox"/> GAPDETECT .....                  | 4         |
| <input type="checkbox"/> BLINEDETECT.....                 | 5         |
| <input type="checkbox"/> AUTODETECT.....                  | 6         |
| <input type="checkbox"/> BLINE.....                       | 7         |
| <input type="checkbox"/> OFFSET .....                     | 8         |
| <input type="checkbox"/> SPEED .....                      | 9         |
| <input type="checkbox"/> DENSITY.....                     | 11        |
| <input type="checkbox"/> DIRECTION AND MIRROR IMAGE ..... | 12        |
| <input type="checkbox"/> REFERENCE.....                   | 13        |
| <input type="checkbox"/> SHIFT .....                      | 14        |
| <input type="checkbox"/> COUNTRY .....                    | 16        |
| <input type="checkbox"/> CODEPAGE.....                    | 17        |
| <input type="checkbox"/> CLS.....                         | 19        |
| <input type="checkbox"/> FEED .....                       | 20        |
| <input type="checkbox"/> BACKFEED & BACKUP .....          | 21        |
| <input type="checkbox"/> FORMFEED .....                   | 22        |
| <input type="checkbox"/> HOME.....                        | 23        |
| <input type="checkbox"/> PRINT .....                      | 24        |
| <input type="checkbox"/> SOUND .....                      | 25        |
| <input type="checkbox"/> CUT.....                         | 26        |
| <input type="checkbox"/> LIMITFEED .....                  | 27        |
| <input type="checkbox"/> SELFTEST .....                   | 28        |
| <input type="checkbox"/> EOJ .....                        | 30        |
| <input type="checkbox"/> DELAY .....                      | 31        |
| <input type="checkbox"/> DISPLAY .....                    | 32        |
| <input type="checkbox"/> INITIALPRINTER.....              | 34        |
| <input type="checkbox"/> MENU.....                        | 35        |
| <b>Label Formatting Commands .....</b>                    | <b>37</b> |
| <input type="checkbox"/> BAR.....                         | 37        |
| <input type="checkbox"/> BARCODE.....                     | 38        |
| <input type="checkbox"/> TLC39 .....                      | 44        |
| <input type="checkbox"/> BITMAP .....                     | 45        |
| <input type="checkbox"/> BOX .....                        | 47        |
| <input type="checkbox"/> CIRCLE .....                     | 48        |
| <input type="checkbox"/> ELLIPSE .....                    | 49        |
| <input type="checkbox"/> CODABLOCK F MODE.....            | 50        |
| <input type="checkbox"/> DMATRIX .....                    | 51        |
| <input type="checkbox"/> ERASE .....                      | 53        |
| <input type="checkbox"/> MAXICODE .....                   | 54        |
| <input type="checkbox"/> PDF417 .....                     | 56        |
| <input type="checkbox"/> AZTEC .....                      | 59        |
| <input type="checkbox"/> MPDF417 .....                    | 60        |
| <input type="checkbox"/> PUTBMP .....                     | 61        |
| <input type="checkbox"/> PUTPCX .....                     | 63        |
| <input type="checkbox"/> QRCODE .....                     | 65        |
| <input type="checkbox"/> RSS .....                        | 71        |

|  |                  |            |
|--|------------------|------------|
| <input type="checkbox"/>                           | REVERSE .....    | 75         |
| <input type="checkbox"/>                           | DIAGONAL.....    | 76         |
| <input type="checkbox"/>                           | TEXT .....       | 77         |
| <input type="checkbox"/>                           | BLOCK.....       | 80         |
| <b>Status Polling and Immediate Commands .....</b> |                  | <b>83</b>  |
| <input type="checkbox"/>                           | <ESC>!P .....    | 83         |
| <input type="checkbox"/>                           | <ESC>!C.....     | 84         |
| <input type="checkbox"/>                           | <ESC>!D .....    | 85         |
| <input type="checkbox"/>                           | <ESC>!O .....    | 86         |
| <input type="checkbox"/>                           | <ESC>!P.....     | 87         |
| <input type="checkbox"/>                           | <ESC>!Q .....    | 88         |
| <input type="checkbox"/>                           | <ESC>!R.....     | 89         |
| <input type="checkbox"/>                           | <ESC>!S .....    | 90         |
| <input type="checkbox"/>                           | <ESC>!F .....    | 92         |
| <input type="checkbox"/>                           | <ESC>!.....      | 93         |
| <input type="checkbox"/>                           | ~!@ .....        | 94         |
| <input type="checkbox"/>                           | ~!A .....        | 95         |
| <input type="checkbox"/>                           | ~!C.....         | 96         |
| <input type="checkbox"/>                           | ~!D .....        | 97         |
| <input type="checkbox"/>                           | ~!E.....         | 98         |
| <input type="checkbox"/>                           | ~!F.....         | 99         |
| <input type="checkbox"/>                           | ~!I.....         | 100        |
| <input type="checkbox"/>                           | ~!T.....         | 101        |
| <input type="checkbox"/>                           | <ESC> Y.....     | 102        |
| <input type="checkbox"/>                           | <ESC> Z.....     | 103        |
| <b>Message Translation Protocols.....</b>          |                  | <b>104</b> |
| <input type="checkbox"/>                           | ~# .....         | 104        |
| <b>Commands for Windows Driver .....</b>           |                  | <b>105</b> |
| <input type="checkbox"/>                           | !B.....          | 105        |
| <input type="checkbox"/>                           | !J .....         | 106        |
| <input type="checkbox"/>                           | !N .....         | 107        |
| <b>File Management Commands .....</b>              |                  | <b>108</b> |
| <input type="checkbox"/>                           | DOWNLOAD .....   | 108        |
| <input type="checkbox"/>                           | EOP.....         | 111        |
| <input type="checkbox"/>                           | FILES.....       | 112        |
| <input type="checkbox"/>                           | KILL.....        | 113        |
| <input type="checkbox"/>                           | MOVE .....       | 115        |
| <input type="checkbox"/>                           | RUN .....        | 116        |
| <b>BASIC Commands and Functions .....</b>          |                  | <b>117</b> |
| <input type="checkbox"/>                           | ABS( ).....      | 117        |
| <input type="checkbox"/>                           | ASC( ).....      | 118        |
| <input type="checkbox"/>                           | CHR\$( ) .....   | 119        |
| <input type="checkbox"/>                           | XOR\$( ) .....   | 120        |
| <input type="checkbox"/>                           | END .....        | 121        |
| <input type="checkbox"/>                           | EOF( ).....      | 122        |
| <input type="checkbox"/>                           | OPEN .....       | 123        |
| <input type="checkbox"/>                           | CLOSE .....      | 125        |
| <input type="checkbox"/>                           | WRITE.....       | 126        |
| <input type="checkbox"/>                           | READ .....       | 127        |
| <input type="checkbox"/>                           | SEEK .....       | 128        |
| <input type="checkbox"/>                           | LOF( ) .....     | 129        |
| <input type="checkbox"/>                           | LOC( ).....      | 130        |
| <input type="checkbox"/>                           | FREAD\$( ) ..... | 131        |
| <input type="checkbox"/>                           | PUT.....         | 132        |
| <input type="checkbox"/>                           | GET.....         | 133        |

|                          |                                     |     |
|--------------------------|-------------------------------------|-----|
| <input type="checkbox"/> | COPY.....                           | 134 |
| <input type="checkbox"/> | FOR...NEXT LOOP.....                | 135 |
| <input type="checkbox"/> | WHILE...WEND .....                  | 136 |
| <input type="checkbox"/> | DO...LOOP .....                     | 137 |
| <input type="checkbox"/> | IF...THEN...ELSE...ENDIF LOOP ..... | 140 |
| <input type="checkbox"/> | GOSUB...RETURN.....                 | 143 |
| <input type="checkbox"/> | GOTO.....                           | 144 |
| <input type="checkbox"/> | INP\$( ) .....                      | 145 |
| <input type="checkbox"/> | INP( ) .....                        | 146 |
| <input type="checkbox"/> | LOB( ).....                         | 147 |
| <input type="checkbox"/> | INPUT .....                         | 148 |
| <input type="checkbox"/> | PREINPUT .....                      | 149 |
| <input type="checkbox"/> | POSTINPUT.....                      | 150 |
| <input type="checkbox"/> | SET FILTER ON/OFF.....              | 151 |
| <input type="checkbox"/> | REM.....                            | 152 |
| <input type="checkbox"/> | OUT .....                           | 153 |
| <input type="checkbox"/> | OUTR.....                           | 154 |
| <input type="checkbox"/> | GETKEY( ).....                      | 155 |
| <input type="checkbox"/> | INT( ).....                         | 156 |
| <input type="checkbox"/> | LEFT\$( ).....                      | 157 |
| <input type="checkbox"/> | LEN( ).....                         | 158 |
| <input type="checkbox"/> | MID\$( ) .....                      | 159 |
| <input type="checkbox"/> | RIGHT\$( ) .....                    | 160 |
| <input type="checkbox"/> | STR\$( ) .....                      | 161 |
| <input type="checkbox"/> | STRCOMP( ) .....                    | 162 |
| <input type="checkbox"/> | INSTR ( ).....                      | 163 |
| <input type="checkbox"/> | TRIM\$( ).....                      | 164 |
| <input type="checkbox"/> | LTRIM\$( ) .....                    | 165 |
| <input type="checkbox"/> | RTRIM\$( ) .....                    | 166 |
| <input type="checkbox"/> | TEXTPIXEL( ) .....                  | 167 |
| <input type="checkbox"/> | BARCODEPIXEL( ).....                | 168 |
| <input type="checkbox"/> | VAL( ) .....                        | 169 |
| <input type="checkbox"/> | BEEP .....                          | 170 |
| <input type="checkbox"/> | NOW\$( ) .....                      | 171 |
| <input type="checkbox"/> | NOW.....                            | 172 |
| <input type="checkbox"/> | FORMAT\$( ) .....                   | 173 |
| <input type="checkbox"/> | DATEADD( ) .....                    | 177 |
| <input type="checkbox"/> | FSEARCH( ) .....                    | 179 |
| <input type="checkbox"/> | TOUCHPRESS( ) .....                 | 180 |
| <input type="checkbox"/> | RECORDSET\$( ) .....                | 181 |
| <input type="checkbox"/> | LABELRATIO.....                     | 183 |
| <input type="checkbox"/> | REPLACE\$( ).....                   | 184 |

**Device Reconfiguration Commands..... 185**

|                          |                             |     |
|--------------------------|-----------------------------|-----|
| <input type="checkbox"/> | SET COUNTER.....            | 185 |
| <input type="checkbox"/> | SET CUTTER .....            | 186 |
| <input type="checkbox"/> | SET PARTIAL_CUTTER .....    | 187 |
| <input type="checkbox"/> | SET BACK .....              | 188 |
| <input type="checkbox"/> | SET KEYN.....               | 189 |
| <input type="checkbox"/> | SET LEDN.....               | 191 |
| <input type="checkbox"/> | SET PEEL .....              | 193 |
| <input type="checkbox"/> | SET REWIND .....            | 194 |
| <input type="checkbox"/> | SET TEAR & SET STRIPER..... | 195 |
| <input type="checkbox"/> | SET GAP .....               | 196 |
| <input type="checkbox"/> | SET BLINE .....             | 198 |
| <input type="checkbox"/> | SET HEAD.....               | 199 |
| <input type="checkbox"/> | SET RIBBON .....            | 200 |

|   |                          |            |
|---|--------------------------|------------|
| <input type="checkbox"/>                        | SET ENCODER .....        | 201        |
| <input type="checkbox"/>                        | SET RIBBONEND .....      | 202        |
| <input type="checkbox"/>                        | SET COM1.....            | 203        |
| <input type="checkbox"/>                        | SET PRINTKEY .....       | 204        |
| <input type="checkbox"/>                        | SET REPRINT .....        | 206        |
| <input type="checkbox"/>                        | SET FEED_LEN .....       | 207        |
| <input type="checkbox"/>                        | GETSENSOR() .....        | 208        |
| <input type="checkbox"/>                        | GETSETTING\$().....      | 211        |
| <input type="checkbox"/>                        | SET USBHOST .....        | 214        |
| <input type="checkbox"/>                        | SET RS232_REWINDER ..... | 215        |
| <input type="checkbox"/>                        | SET AUTORUN .....        | 216        |
| <input type="checkbox"/>                        | SET VERIFIER.....        | 217        |
| <input type="checkbox"/>                        | SET RESPONSE.....        | 218        |
| <input type="checkbox"/>                        | SET DAYLIGHT_SAVE.....   | 220        |
| <input type="checkbox"/>                        | PEEL.....                | 221        |
| <input type="checkbox"/>                        | LED1, LED2, LED3.....    | 222        |
| <input type="checkbox"/>                        | KEY1, KEY2, KEY3 .....   | 224        |
| <b>Printer Global Variables .....</b>           |                          | <b>226</b> |
| <input type="checkbox"/>                        | @LABEL.....              | 226        |
| <input type="checkbox"/>                        | YEAR .....               | 227        |
| <input type="checkbox"/>                        | MONTH .....              | 228        |
| <input type="checkbox"/>                        | DATE .....               | 229        |
| <input type="checkbox"/>                        | WEEK.....                | 230        |
| <input type="checkbox"/>                        | HOUR .....               | 231        |
| <input type="checkbox"/>                        | MINUTE.....              | 232        |
| <input type="checkbox"/>                        | SECOND.....              | 233        |
| <input type="checkbox"/>                        | @YEAR .....              | 234        |
| <input type="checkbox"/>                        | @MONTH .....             | 235        |
| <input type="checkbox"/>                        | @DATE .....              | 236        |
| <input type="checkbox"/>                        | @DAY .....               | 237        |
| <input type="checkbox"/>                        | @HOUR.....               | 238        |
| <input type="checkbox"/>                        | @MINUTE .....            | 239        |
| <input type="checkbox"/>                        | @SECOND .....            | 240        |
| <input type="checkbox"/>                        | _MODEL\$.....            | 241        |
| <input type="checkbox"/>                        | _SERIAL\$ .....          | 242        |
| <input type="checkbox"/>                        | _VERSION\$.....          | 243        |
| <b>Bluetooth Module Setting Commands.....</b>   |                          | <b>244</b> |
| <input type="checkbox"/>                        | BT NAME .....            | 244        |
| <input type="checkbox"/>                        | BT PINCODE.....          | 245        |
| <b>Wi-Fi Module Setting Commands .....</b>      |                          | <b>246</b> |
| <input type="checkbox"/>                        | WLAN OFF .....           | 246        |
| <input type="checkbox"/>                        | WLAN SSID .....          | 247        |
| <input type="checkbox"/>                        | WLAN WPA.....            | 248        |
| <input type="checkbox"/>                        | WLAN WEP .....           | 249        |
| <input type="checkbox"/>                        | WLAN DHCP .....          | 250        |
| <input type="checkbox"/>                        | WLAN IP .....            | 251        |
| <input type="checkbox"/>                        | WLAN PORT.....           | 252        |
| <b>Internal Ethernet Setting Commands .....</b> |                          | <b>253</b> |
| <input type="checkbox"/>                        | NET DHCP .....           | 253        |
| <input type="checkbox"/>                        | NET IP .....             | 254        |
| <input type="checkbox"/>                        | NET PORT .....           | 255        |
| <input type="checkbox"/>                        | NET NAME.....            | 256        |
| <b>NFC Setting Commands.....</b>                |                          | <b>257</b> |
| <input type="checkbox"/>                        | NFC FEATURE .....        | 257        |
| <input type="checkbox"/>                        | NFC STATUS .....         | 258        |

|                                       |   |            |
|---------------------------------------|---|------------|
| <input type="checkbox"/>              | NFC TIMEOUT.....  | 259        |
| <input type="checkbox"/>              | NFC READ .....  | 260        |
| <input type="checkbox"/>              | NFC WRITE .....   | 261        |
| <input type="checkbox"/>              | NFC MODE.....   | 262        |
| <b>Alpha-2R Setting Commands.....</b> |   | <b>263</b> |
| <input type="checkbox"/>              | SET PRINTQUALITY .....  | 263        |
| <input type="checkbox"/>              | SET STANDBYTIME.....  | 264        |
| <input type="checkbox"/>              | SET SLEEPTIME .....   | 265        |
| <input type="checkbox"/>              | GETSETTING\$().....   | 266        |
| <b>GPIO Setting Commands.....</b>     |   | <b>267</b> |
| <input type="checkbox"/>              | SET GPO.....  | 267        |
| <input type="checkbox"/>              | SET GPI .....   | 269        |
| <input type="checkbox"/>              | GPIO INTERFACE (HD15F) CIRCUIT DIAGRAM [TTP-2410MT/ MXP/ MH SERIES] ..... | 272        |
| <input type="checkbox"/>              | APPLICATOR I/O INTERFACE (DB15F) CIRCUIT DIAGRAM [PEX-1000 SERIES] .....  | 274        |
| <b>Update History .....</b>           |   | <b>275</b> |

# How to Read

## ● **MPDF417**

The command name

### Description

This command defines a Micro PDF 417 bar code.

Description of this command

### Syntax

**MPDF417 x, y, rotate, [Wn,][Hn,][Cn],"content"**

Syntax of this command

| <u>Parameter</u> | <u>Description</u>  |
|------------------|---|
| x                | Horizontal start position (in dots)   |
| y                | Vertical start position (in dots)   |
| rotate           | Rotation<br>0 : No rotation<br>90 : Rotate 90 degrees<br>180 : Rotate 180 degrees<br>270 : Rotate 270 degrees   |
| Wn               | Optional. Module width in dot. Default is 1.  |
| Hn               | Optional. Module height in dot. Default is 10.  |
| Cn               | Optional. Number of columns. Once the parameter is set, the printer will calculate the proper rows for the barcode base on the content automatically.<br>0: Auto mode.<br>1: Column is 1 and the calculated suitable rows will be 11, 14, 17, 20, 24, and 28.<br>2: Column is 2 and the calculated suitable rows will be 8, 11, 14, 17, 20, 23 and 26.<br>3: Column is 3 and the calculated suitable rows will be 6, 8, 10, 12, 15, 20, 26, 32, 38 and 44.<br>4: Column is 4 and the calculated suitable rows will be 4, 6, 8, 10, 12, 15, 20, 26, 32, 38 and 44. |
| "content"        | Content of Micro PDF 417 bar code   |

**Note:**  
*This command has been supported since V6.61 EZ and later firmware.*

The detail description of each parameter

### Example

**Sample Code**

```
SIZE 4,1  
GAP 0,0  
CLS  
MPDF417 10,10,0,"ABCDEFGHJKLMNOPQRSTUVWXYZ0123456789"  
MPDF417 110,10,0,W2,"ABCDEFGHJKLMNOPQRSTUVWXYZ0123456789"  
MPDF417 210,10,0,W2,H3,"ABCDEFGHJKLMNOPQRSTUVWXYZ0123456789"  
MPDF417 310,10,0,W2,H3,C3,"ABCDEFGHJKLMNOPQRSTUVWXYZ0123456789"  
PRINT 1
```

**Result**



The example and printout for reference



# Document Conventions

This manual uses the following typographic conventions.

| Convention   | Description  |
|--|--|
| [expression list]                                    | Items inside square brackets are optional, expression maximum length 2*1024 bytes.                           |
| <ESC>  | ASCII 27, control code of status polling command returns/runs the printer status immediately.                |
| ~  | ASCII 126, control code of status polling command returns the printer status only when the printer is ready. |
| Space  | ASCII 32, characters will be ignored in the command line.  |
| "  | ASCII 34, beginning and ending of expression.  |
| CR, LF   | ASCII 13, ASCII 10, denotes end of command line.   |
| NULL   | ASCII 0, supported in the expression.  |
| <b>Note:</b><br><b><i>203 DPI: 1 mm = 8 dots</i></b> | The font in bold and italic type is used for note.   |

# Object Position Calculation

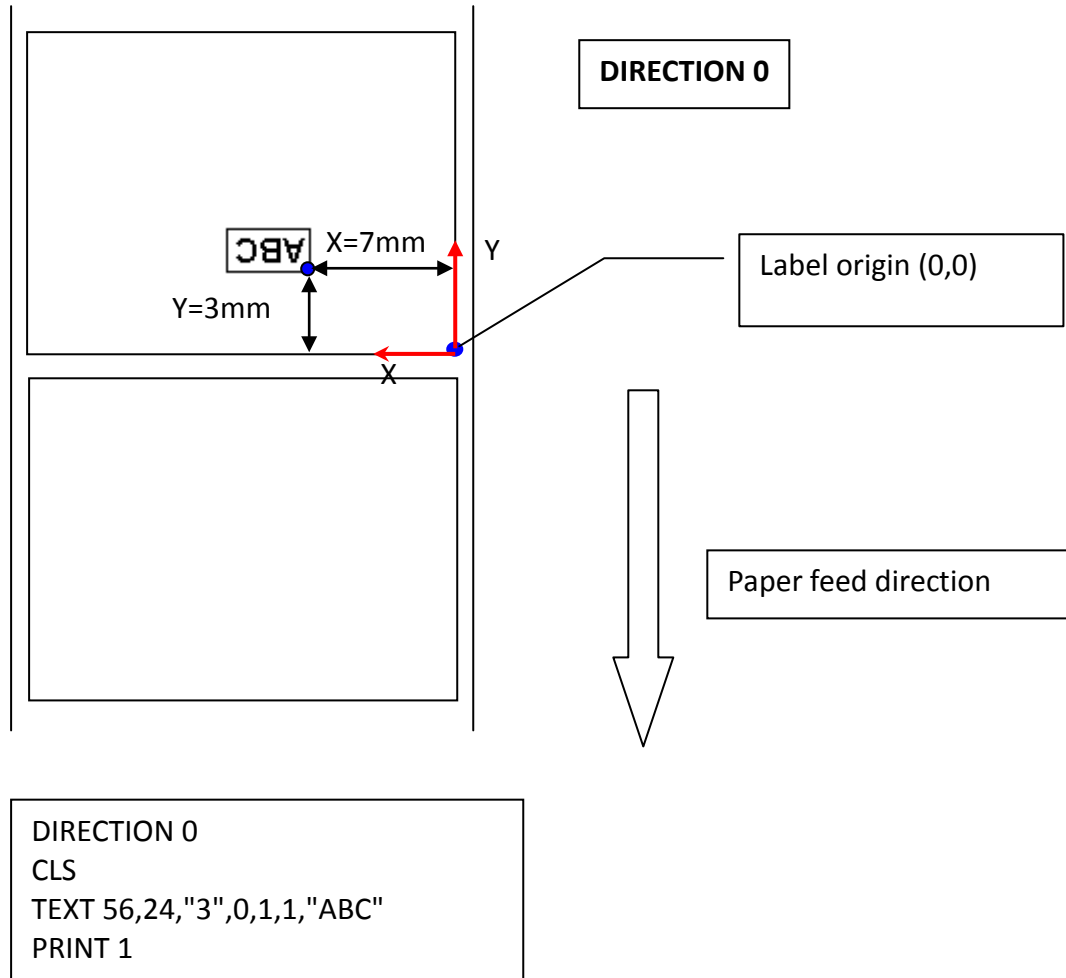

**Note :**

- 1. 203 DPI, 1mm=8 dots ; 300 DPI, 1mm=11.8 dots**
- 2. Only integer portion will be used. Ex. 2 mm = 23.6 dots then 23 dots will be used.**

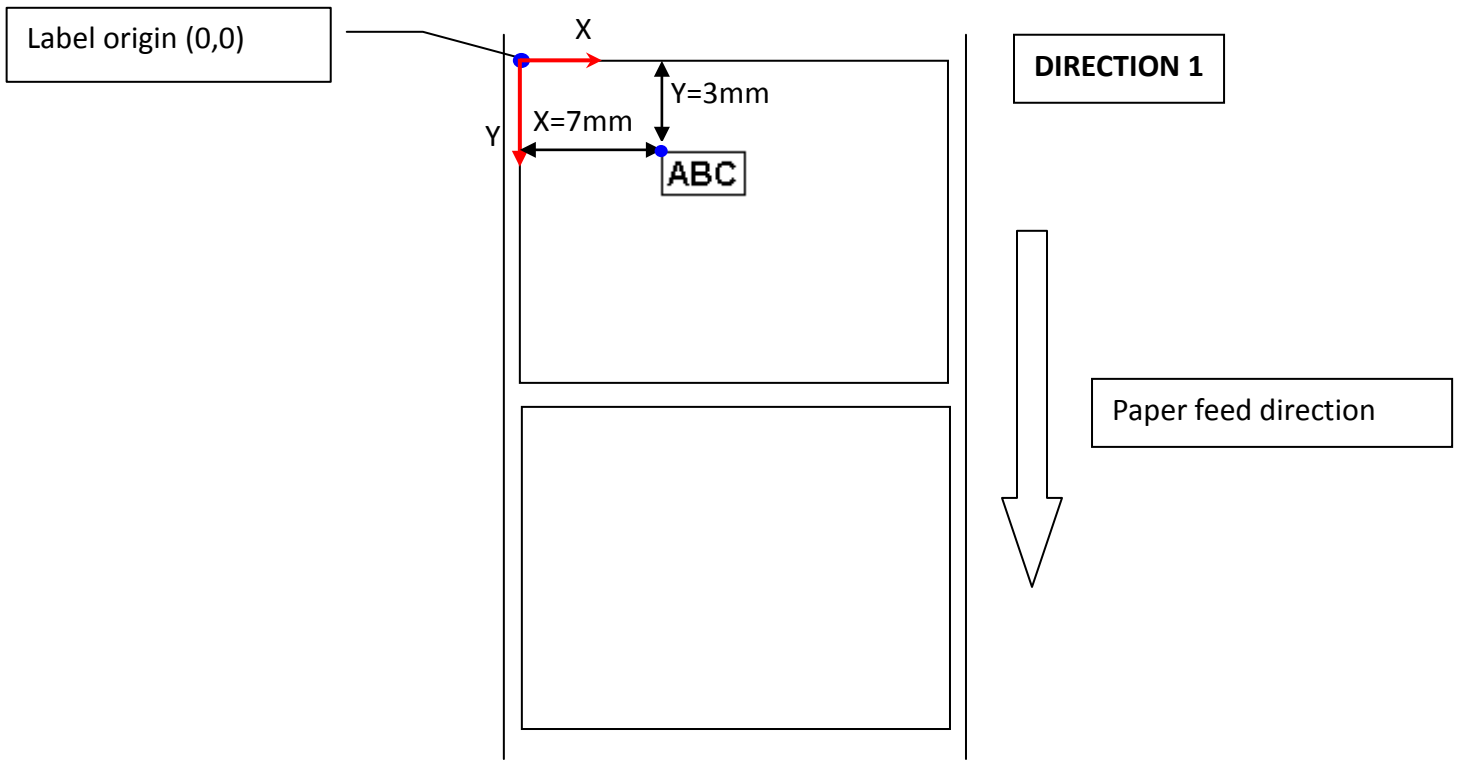

```

DIRECTION 1
CLS
TEXT 56,24,"3",0,1,1,"ABC"
PRINT 1

```

# Printer Model List

| Series                                   | Models  | Support Programming | F/W Version | F/W Maintainability |
|--|---|---------------------|-------------|---------------------|
| TDP-643 Plus                             | TDP-643 Plus  | TSPL                | V x.x       | No                  |
| TTP-243 series                           | TTP-243, TTP-243E, TTP-342                                    | TSPL                | V x.x       | No                  |
| TTP-244ME series                         | TTP-243M, TTP-244ME, TTP-342M                                 | TSPL                | V x.x       | No                  |
| TDP-245 series                           | TDP-245, TDP-245G   | TSPL2               | V x.x       | No                  |
| TTP-245 series                           | TTP-245, TTP-245G, TTP-343                                    | TSPL2               | V x.x       | No                  |
| TTP-246M series                          | TTP-246M, TTP-246G, TTP-344M                                  | TSPL2               | V x.x       | No                  |
| TTP-248M series                          | TTP-248M  | TSPL2               | V x.x       | No                  |
| TDP-643R Plus                            | TDP-643R Plus   | TSPL                | V x.x       | No                  |
| TTP-243 Plus series                      | TTP-243 Plus, TTP-243E Plus, TTP-342 Plus                     | TSPL                | V x.x       | No                  |
| TTP-244ME Plus                           | TTP-244ME Plus, TTP-342M Plus                                 | TSPL                | V x.x       | No                  |
| TTP-2410M series<br>TTP-246M Plus series | TTP-2410M, TTP-346M, TTP-644M<br>TTP-246M Plus, TTP-344M Plus | TSPL2               | V x.x       | No                  |
| TTP-244 series                           | TTP-244   | TSPL2               | V x.x       | No                  |
| M23 series                               | M23   | TSPL2               | V x.x       | No                  |
| TTP-244 Plus series                      | TTP-244 Plus  | TSPL2               | V x.x       | No                  |
| TA200 series                             | TA200, TA300  | TSPL2               | V x.x       | No                  |
| TTP-245C series                          | TTP-245C, TTP-343C  | TSPL2               | V x.x       | No                  |
| TTP-2410M Pro series                     | TTP-2410M Pro, TTP-346M Pro, TTP-644M Pro                     | TSPL2               | V x.x       | No                  |
| TTP-268M series                          | TTP-268M, TTP-366M  | TSPL2               | V x.x       | No                  |
| TTP-384M series                          | TTP-384M  | TSPL2               | V x.x       | No                  |
| TTP-243 Pro series                       | TTP-243 Pro, TTP-243E Pro, TTP-342 Pro                        | TSPL                | V x.x       | Yes                 |
| TTP-244 Pro series                       | TTP-244 Pro   | TSPL2               | V x.x       | Yes                 |
| TDP-247 series                           | TDP-245 Plus, TDP-244, TDP-247, TDP-345                       | TSPL2               | V x.x       | Yes                 |
| DA200 series                             | DA200, DA300  | TSPL2               | A x.x       | Yes                 |
| TTP-247 series                           | TTP-245 Plus, TTP-343 Plus, TTP-247, TTP-345                  | TSPL2               | V x.x       | Yes                 |
| TE200 series                             | TE200, TE300  | TSPL2               | A x.x       | Yes                 |
| TX200 series                             | TX200, TX300, TX600   | TSPL2               | A x.x       | Yes                 |
| TDP-225 series                           | TDP-225, TDP-324, TDP-225W, TDP-324W                          | TSPL2               | V x.x       | Yes                 |
| TTP-225 series                           | TTP-225, TTP-323  | TSPL2               | V x.x       | Yes                 |
| TTP-244CE                                | TTP-244CE   | TSPL2               | V x.x       | Yes                 |
| TC200 series                             | TC200, TC300, TC210, TC310                                    | TSPL2               | A x.x       | Yes                 |
| TA210 series                             | TA210, TA310  | TSPL2               | V x.x       | Yes                 |
| TTP-244M Pro                             | TTP-244M Pro, TTP-244ME Pro,                                  | TSPL2               | V x.x       | Yes                 |

|  |   |       |       |     |
|--|---|-------|-------|-----|
| series                                 | TTP-342M Pro, TTP-342ME Pro   |       |       |     |
| ME240 series                           | ME240, ME340  | TSPL2 | V x.x | Yes |
| MB240 series                           | MB240, MB340, MB240T, MB340T  | TSPL2 | A x.x | Yes |
| ML240 series                           | ML240, ML340, ML240P, ML340P  | TSPL2 | A x.x | Yes |
| TTP-246M Pro series                    | TTP-246M Pro, TTP-344M Pro  | TSPL2 | V x.x | Yes |
| TTP-2410MU series<br>TTP-2410MT series | TTP-2410MU, TTP-346MU,<br>TTP-644MU, TTP-2410MT,<br>TTP-346MT, TTP-644MT  | TSPL2 | A x.x | Yes |
| MX240 series                           | MX240, MX340, MX640   | TSPL2 | A x.x | Yes |
| MX240P series                          | MX240P, MX340P, MX640P  | TSPL2 | A x.x | Yes |
| MH240 series                           | MH240, MH340, MH640, MH240T,<br>MH340T, MH640T, MH240P,<br>MH340P, MH640P | TSPL2 | A x.x | Yes |
| TTP-2610M series                       | TTP-2610MT, TTP-368MT   | TSPL2 | A x.x | Yes |
| TTP-286MT series                       | TTP-286MT, TTP-384MT  | TSPL2 | A x.x | Yes |
| Alpha-2R series                        | Alpha-2R  | TSPL2 | A x.x | Yes |
| Alpha-3R series                        | Alpha-3R  | TSPL2 | V x.x | Yes |
| Alpha-4L series                        | Alpha-4L  | TSPL2 | V x.x | Yes |

**The commands listed in the TSPL2 programming manual are included in all printer models firmware. The printer may not support the related commands if the function is not included in the printer specification.**

# Setup and System Commands

## ● SIZE

### Description

This command defines the label width and length.

### Syntax

|                          |  |
|--------------------------|--|
| <b>SIZE m[n]</b>         | English system (inch)  |
| <b>SIZE m mm[n mm]</b>   | Metric system (mm)   |
| <b>SIZE m dot[n dot]</b> | Dot measurement<br><i>This command has been supported since V6.27 EZ and later firmware.</i> |

| <u>Parameter</u> | <u>Description</u>   |
|------------------|--|
| M                | Label width (inch/ mm/ dot)  |
| [N]              | Label length (inch/ mm/ dot); <i>This item can be optional since V8.13 &amp; A2.10 and later firmware.</i> |

**Note :**

- **200 DPI : 1 mm = 8 dots**
- **300 DPI : 1mm = 12 dots**
- **For metric and dot systems, there must be a space between parameter and “mm” or “dot”.**

### Example

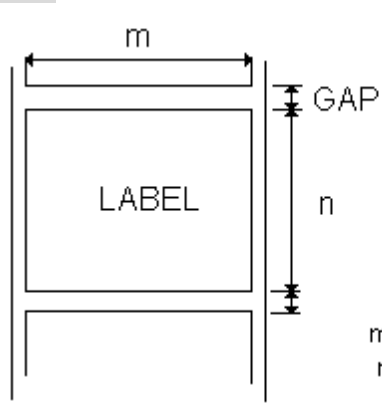
| <u>Sample Code</u>  | <u>Result</u>  |
|---|--|
| <ul style="list-style-type: none"><li>▪ English system (inch):<br/><b>SIZE 3.5,3.00</b></li><li>▪ Metric system (mm):<br/><b>SIZE 100 mm,100 mm</b></li></ul> |  <p>m: Label Width<br/>n: Label Height</p> |

### See Also

GAP, BLINE

## ● GAP

### Description

Defines the gap distance between two labels.

### Syntax

|                        |  |
|------------------------|--|
| <b>GAP m,n</b>         | English system (inch)  |
| <b>GAP m mm,n mm</b>   | Metric system (mm)   |
| <b>GAP m dot,n dot</b> | Dot measurement<br><i>This command has been supported since V6.27 EZ and later firmware.</i> |

| <u>Parameter</u> | <u>Description</u>  |
|------------------|---|
| M                | The gap distance between two labels<br>$0 \leq m \leq 1$ (inch), $0 \leq m \leq 25.4$ (mm)                                      |
| N                | The offset distance of the gap<br>$0 \leq n \leq 5$ (inch), $0 \leq n \leq 127$ (mm) / <i>since V6.21 EZ and later firmware</i> |
| 0, 0             | Continuous label  |

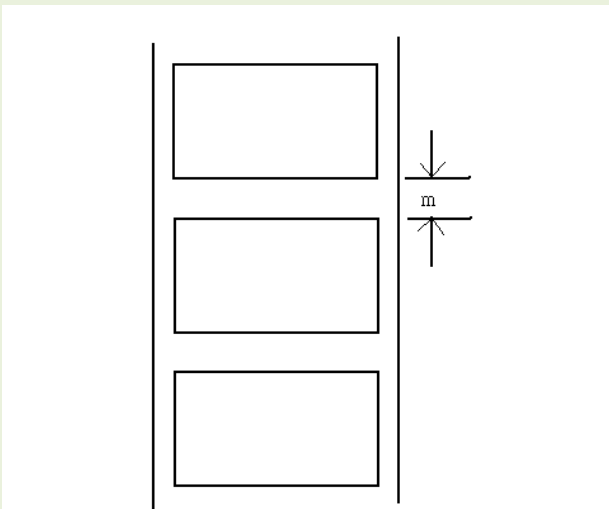
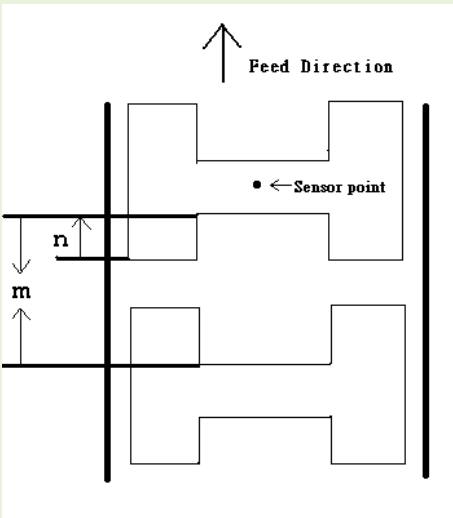
**Note :**

- **200 DPI : 1 mm = 8 dots**
- **300 DPI : 1mm = 12 dots**
- **For metric and dot systems, there must be a space between parameter and mm.**
- **When the sensor type is changed from "Black Mark" to "GAP", please send the "GAP" command to the printer first.**

## Example

| Sample Code   | Result  |
|---|---|
| <p><b>Normal gap</b></p> <ul style="list-style-type: none"> <li>▪ English system (inch):<br/><b>GAP 0.12,0</b></li> <li>▪ Metric system (mm):<br/><b>GAP 3 mm,0 mm</b></li> <li>▪ Continuous label:<br/><b>GAP 0,0</b></li> </ul> | <p><b>Normal gap</b></p>  <p>The diagram shows three rectangular labels stacked vertically. To the right of the labels is a vertical line representing a sensor. A horizontal line with arrows at both ends indicates the gap between the labels and the sensor. The gap is labeled with the letter 'm'.</p>   |
| <p><b>Special gap</b></p> <ul style="list-style-type: none"> <li>▪ English system (inch)<br/><b>GAP 0.30,0.10</b></li> <li>▪ Metric system (mm)<br/><b>GAP 7.62 mm,2.54 mm</b></li> </ul>   | <p><b>Special gap</b></p>  <p>The diagram shows a complex label shape with a vertical line representing a sensor. An arrow labeled 'Feed Direction' points upwards. A dot labeled 'Sensor point' is located on the vertical line. The gap between the label and the sensor is labeled with the letter 'n'. The distance between the sensor and the label is labeled with the letter 'm'.</p> |

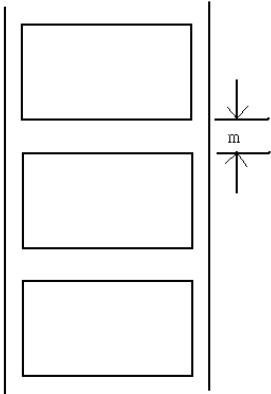
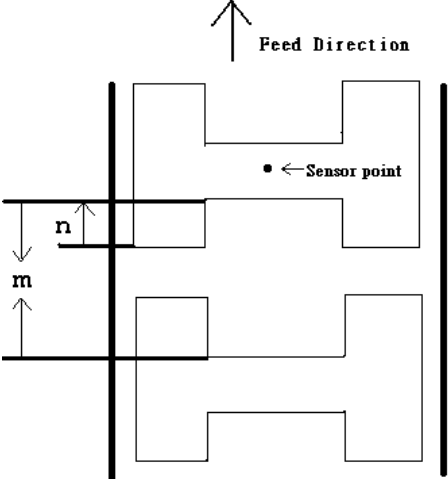
## See Also

SIZE, BLINE



## ● GAPDETECT

### Description

This command feeds the paper through the gap sensor in an effort to determine the paper and gap sizes, respectively. This command references the user's approximate measurements. If the measurements conflict with the actual size, the GAPDETECT command will not work properly. This calibration method can be applied to the labels with pre-printed logos or texts.

### Syntax

**GAPDETECT [x,y]**

| <u>Parameter</u> | <u>Description</u>     |
|------------------|------------------------|
| X                | Paper length (in dots) |
| Y                | Gap length (in dots)   |

**Note:**  
*If the x, y parameters are ignored then the printer will calibrate and determine the paper length and gap size automatically.*

### See Also

GAP, SIZE, BLINEDETECT, AUTODETECT

## ● BLINEDETECT

### Description

This command feeds the paper through the black mark sensor in an effort to determine the paper and black mark sizes, respectively. This command references the user's approximate measurements. If the measurements conflict with the actual size, the BLINEDETECT command will not work properly. This calibration method can be applied to the labels with pre-printed logos or texts.

### Syntax

**BLINEDETECT [x,y]**

| <u>Parameter</u> | <u>Description</u>     |
|------------------|------------------------|
| x                | Paper length (in dots) |
| y                | Gap length (in dots)   |

**Note:**  
*If the x, y parameters are ignored then the printer will calibrate and determine the paper length and gap size automatically.*

### See Also

GAP, SIZE, GAPDETECT, AUTODETECT

## ● AUTODETECT

### Description

This command feeds the paper through the gap/black mark sensor in an effort to determine the paper and gap/black mark sizes, respectively. This command references the user's approximate measurements. If the measurements conflict with the actual size, the AUTODETECT command will not work properly. This calibration method can be applied to the labels with pre-printed logos or texts.

### Syntax

**AUTODETECT [x,y]**

| <u>Parameter</u> | <u>Description</u>     |
|------------------|------------------------|
| x                | Paper length (in dots) |
| y                | Gap length (in dots)   |

**Note:**

- *If the x, y parameters are ignored then the printer will calibrate and determine the paper length and gap/black mark size automatically.*
- *When using this command, the printer will detect the label by the proper sensor type so please don't set the command GAP or BLINE in your program.*
- *It is supported in firmware V6.86 EZ or later.*

### See Also

GAP, SIZE, GAPDETECT, BLINEDETECT

## ● BLINE

### Description

This command sets the height of the black line and the user-defined extra label feeding length each form feed takes.

### Syntax

|                          |                       |
|--------------------------|-----------------------|
| <b>BLINE m,n</b>         | English system (inch) |
| <b>BLINE m mm,n mm</b>   | Metric system (mm)    |
| <b>BLINE m dot,n dot</b> | Dot measurement       |

*This command has been supported since V6.27 EZ and later firmware.*

| Parameter | Description   |
|-----------|---|
| m         | The height of black line either in inch or mm<br>$0 \leq m \leq 1$ (inch), $0 \leq m \leq 25.4$ (mm)<br>$0 \leq m \leq 5$ (inch), $0 \leq m \leq 127$ (mm) / <i>since V6.21 EZ and later firmware</i> |
| n         | The extra label feeding length<br>$0 \leq n \leq \text{label length}$   |
| 0,0       | Continuous label  |

**Note:**

- For metric system, there must be a space between parameter and mm.
- When the sensor type is changed from "GAP" to "Black Mark", please send the "BLINE" command to the printer first.
- 200 DPI : 1 mm = 8 dots  
300 DPI : 1mm = 12 dots

### Example

| Sample Code   |
|---|
| <ul style="list-style-type: none"> <li>▪ English system (inch):<br/><b>BLINE 0.20,0.50</b></li> <li>▪ Metric system (mm):<br/><b>BLINE 5.08 mm,12.7 mm</b></li> </ul> |

### See Also

SIZE, GAP

## ● OFFSET

### Description

This command defines the selective, extra label feeding length each form feed takes, which, especially in peel-off mode and cutter mode, is used to adjust label stop position, so as for label to register at proper places for the intended purposes. The printer back tracks the extra feeding length before the next run of printing.

### Syntax

|                     |  |
|---------------------|--|
| <b>OFFSET m</b>     | English system (inch)  |
| <b>OFFSET m mm</b>  | Metric system (mm)   |
| <b>OFFSET m dot</b> | Dot measurement<br><i>This command has been supported since V6.27 EZ and later firmware.</i> |

| <u>Parameter</u> | <u>Description</u>  |
|------------------|---|
| m                | The offset distance (inch or mm)<br>$-1 \leq m \leq 1$ (inch) |

**CAUTION:**

- *Improperly offset value may cause paper jam.*
- *For metric system, there must be a space between parameter and mm.*
- **200 DPI : 1 mm = 8 dots**
- **300 DPI : 1mm = 12 dots**

### Example

#### Sample Code

- English system (inch):  
**OFFSET 0.5**
- Metric system (mm):  
**OFFSET 12.7 mm**

### See Also

SIZE, GAP, SET PEEL, SET CUTTER

## ● SPEED

### Description

This command defines the print speed.

### Syntax

**SPEED n**

| <u>Parameter</u>                                    | <u>Description</u>                |     |   |     |   |     |   |   |   |   |   |   |    |    |    |    |    |    |    |    |    |
|---|-----------------------------------|-----|---|-----|---|-----|---|---|---|---|---|---|----|----|----|----|----|----|----|----|----|
| n   | Printing speed in inch per second |     |   |     |   |     |   |   |   |   |   |   |    |    |    |    |    |    |    |    |    |
| Model / IPS   | 1                                 | 1.5 | 2 | 2.5 | 3 | 3.5 | 4 | 5 | 6 | 7 | 8 | 9 | 10 | 11 | 12 | 13 | 14 | 15 | 16 | 17 | 18 |
| TDP-643 Plus/ TDP-643R Plus series                  |                                   | V   | V |     | V |     |   |   |   |   |   |   |    |    |    |    |    |    |    |    |    |
| TTP-243I/ TTP-243I Plus/ TTP-243I Pro series        |                                   | V   | V |     | V |     |   |   |   |   |   |   |    |    |    |    |    |    |    |    |    |
| TTP-342/ TTP-342 Plus/ TTP-342I Pro series          | V                                 | V   | V |     |   |     |   |   |   |   |   |   |    |    |    |    |    |    |    |    |    |
| TTP-244/ TTP-244 Plus series                        |                                   |     | V |     | V |     | V |   |   |   |   |   |    |    |    |    |    |    |    |    |    |
| TTP-244 Pro series                                  |                                   |     | V |     | V |     | V | V |   |   |   |   |    |    |    |    |    |    |    |    |    |
| TDP-244 series                                      |                                   |     | V |     | V |     | V |   |   |   |   |   |    |    |    |    |    |    |    |    |    |
| TDP-245/ TDP-245 Plus/ TTP-245/ TTP-245 Plus series |                                   |     | V |     | V |     | V | V |   |   |   |   |    |    |    |    |    |    |    |    |    |
| TDP-247/ TTP-247 series                             |                                   |     | V |     | V |     | V | V | V | V |   |   |    |    |    |    |    |    |    |    |    |
| TTP-343/ TTP-343 Plus series                        |                                   |     | V |     | V |     |   |   |   |   |   |   |    |    |    |    |    |    |    |    |    |
| TDP-345/ TTP-345 series                             |                                   |     | V |     | V |     | V | V |   |   |   |   |    |    |    |    |    |    |    |    |    |
| TTP-244CE/ TTP-343C series                          |                                   |     | V |     | V |     | V |   |   |   |   |   |    |    |    |    |    |    |    |    |    |
| TTP-245C series/ TE200 series                       |                                   |     | V |     | V |     | V | V | V |   |   |   |    |    |    |    |    |    |    |    |    |
| TA200/ DA300 series                                 |                                   |     | V |     | V |     | V |   |   |   |   |   |    |    |    |    |    |    |    |    |    |
| TA210/ DA200 series/ TE300 series                   |                                   |     | V |     | V |     | V | V |   |   |   |   |    |    |    |    |    |    |    |    |    |
| TA300 series  |                                   | V   | V |     | V |     |   |   |   |   |   |   |    |    |    |    |    |    |    |    |    |
| TA310 series  |                                   | V   | V |     | V |     | V |   |   |   |   |   |    |    |    |    |    |    |    |    |    |
| TX200 series  |                                   |     | V |     | V |     | V | V | V | V | V |   |    |    |    |    |    |    |    |    |    |
| TX300 series  |                                   |     | V |     | V |     | V | V | V |   |   |   |    |    |    |    |    |    |    |    |    |
| TX600 series  | V                                 | V   | V |     | V |     | V |   |   |   |   |   |    |    |    |    |    |    |    |    |    |
| TDP-225/ TTP-225 series                             |                                   |     | V |     | V |     | V | V |   |   |   |   |    |    |    |    |    |    |    |    |    |
| TDP-324/TDP-324W series                             |                                   |     | V |     | V |     | V |   |   |   |   |   |    |    |    |    |    |    |    |    |    |
| TTP-323   |                                   |     | V |     | V |     |   |   |   |   |   |   |    |    |    |    |    |    |    |    |    |
| TTP-246M series                                     |                                   |     | V |     | V |     | V | V | V |   |   |   |    |    |    |    |    |    |    |    |    |
| TTP-246M Plus/ TTP-246M Pro series                  |                                   |     | V |     | V |     | V | V | V | V | V |   |    |    |    |    |    |    |    |    |    |
| TTP-248M series                                     |                                   |     |   |     |   |     | V | V | V |   | V |   |    |    |    |    |    |    |    |    |    |
| TTP-2410M/TTP-2410M Pro series                      |                                   |     | V |     | V |     | V | V | V | V | V | V | V  | V  | V  |    |    |    |    |    |    |
| TTP-244ME/ TTP-244ME Plus/ TTP-244MI Pro series     |                                   | V   | V |     | V |     | V |   |   |   |   |   |    |    |    |    |    |    |    |    |    |
| TTP-342M/ TTP-342M Plus/ TTP-342M Pro series        | V                                 | V   | V |     |   |     |   |   |   |   |   |   |    |    |    |    |    |    |    |    |    |
| TTP-344M series                                     |                                   |     | V |     | V |     | V |   |   |   |   |   |    |    |    |    |    |    |    |    |    |
| TTP-344M Plus/ TTP-344M Pro series                  |                                   |     | V |     | V |     | V | V | V |   |   |   |    |    |    |    |    |    |    |    |    |
| TTP-346M/ TTP-346M Pro series                       |                                   |     | V |     | V |     | V | V | V | V | V |   |    |    |    |    |    |    |    |    |    |
| TTP-644M/ TTP-246M Pro series                       | V                                 |     | V |     | V |     | V |   |   |   |   |   |    |    |    |    |    |    |    |    |    |
| TTP-268M series                                     |                                   |     | V |     | V |     | V | V | V | V | V |   |    |    |    |    |    |    |    |    |    |
| TTP-366M series                                     |                                   |     | V |     | V |     | V | V | V |   |   |   |    |    |    |    |    |    |    |    |    |
| TTP-286MT series                                    |                                   |     | V |     | V |     | V | V | V |   |   |   |    |    |    |    |    |    |    |    |    |
| TTP-384M/ TTP-384MT series                          |                                   |     | V |     | V |     | V |   |   |   |   |   |    |    |    |    |    |    |    |    |    |
| ME240 series  |                                   |     | V |     | V |     | V | V | V |   |   |   |    |    |    |    |    |    |    |    |    |
| ME340 series  |                                   | V   | V |     | V |     | V |   |   |   |   |   |    |    |    |    |    |    |    |    |    |
| MX240P series                                       |                                   |     | V |     | V |     | V | V | V | V | V | V | V  | V  | V  | V  | V  | V  | V  | V  | V  |



## ● DENSITY

### Description

This command sets the printing darkness.

### Syntax

**DENSITY n**

| <u>Parameter</u> | <u>Description</u>   |
|------------------|--|
| n                | 0~15<br>0: specifies the lightest level<br>15: specifies the darkest level |

**Note:**

***Default DENSITY setting is 8.***

### Example

**Sample code**

```
DENSITY 7
```



## ● DIRECTION and Mirror Image

### Description

This command defines the printout direction and mirror image. This will be stored in the printer memory.

### Syntax

**DIRECTION n[,m]**

| <u>Parameter</u> | <u>Description</u>  |
|------------------|---|
| n                | 0 or 1. Please refer to the illustrations below   |
| m                | 0: Print normal image<br>1: Print mirror image<br><small>(Note: TDP-643 Plus , TTP-243, TTP-342, TTP-244ME, TTP-342M and TTP-248M series are not supported this mirror feature)</small> |

DIRECTION 0,0  
*Feed Direction*  
↓  
TEST PRINT

DIRECTION 1,0  
**TEST PRINT**  
*Feed Direction*  
↓

DIRECTION 0,1  
*Feed Direction*  
↓  
TEST PRINT

DIRECTION 1,1  
**TEST PRINT**  
*Feed Direction*  
↓

### Example

#### Sample code

- **DIRECTION 0**
  
- **DIRECTION 0,1**

### See Also

## REFERENCE

### ● REFERENCE

#### Description

This command defines the reference point of the label. The reference (origin) point varies with the print direction, as shown:

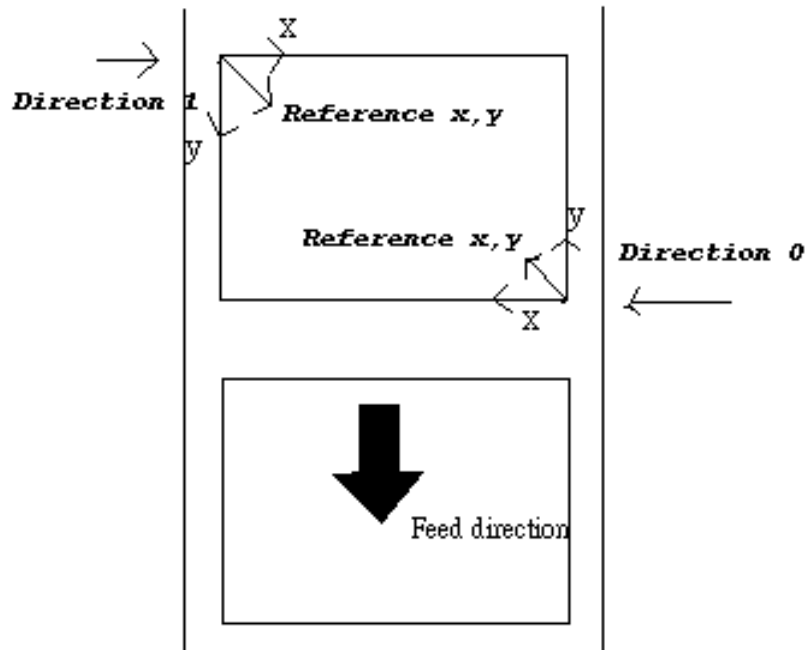

#### Syntax

**REFERENCE** *x, y*

| <u>Parameter</u> | <u>Description</u>              |
|------------------|---------------------------------|
| <i>x</i>         | Horizontal coordinate (in dots) |
| <i>y</i>         | Vertical coordinate (in dots)   |

**Note:**

**200 DPI: 1 mm = 8 dots**

**300 DPI: 1 mm = 12 dots**

#### Example

**Sample code**

```
REFERENCE 10,10
```

#### See Also

DIRECTION

## ● SHIFT

### Description

This command moves the label's horizontal and vertical position. A positive value moves the label further from the printing direction; a negative value moves the label towards the printing direction.

### Syntax

SHIFT [x,] y

| Parameter | Description   |
|-----------|---|
| x         | Optional. The maximum value is 1 inch. For 200 dpi printers, the range is -203 to 203; for 300 dpi printers, the range is -300 to 300. The unit is dot. |
| Y         | The maximum value is 1 inch. For 200 dpi printers, the range is -203 to 203; for 300 dpi printers, the range is -300 to 300. The unit is dot.           |

(Note: TDP-643 Plus , TTP-243, TTP-342, TTP-244ME, TTP-342M, TTP-248M and M23 series are not supported this feature)

### Example

**Sample Code**

```

SIZE 4,2.5
GAP 2 mm,0
DIRECTION 0
SHIFT 36
OFFSET 0
CLS
TEXT 400,200, "3",0,1,1, "DIRECTION 0"
TEXT 400,250, "3",0,1,1, "SHIFT 36"
BOX 10,0,780,490,8
PRINT 3,1
        
```

**Result**

The result shows a 2x3 grid of label examples. The top row shows two labels with 'DIRECTION 0' and 'SHIFT 36' text. The bottom row shows two labels with 'DIRECTION 1' and 'SHIFT 0' and 'DIRECTION 1' and 'SHIFT 36' text. A red arrow on the right indicates the 'Printing Direction' pointing downwards.

## See Also

OFFSET, REFERENCE

## ● COUNTRY

### Description

This command orients the keyboard for use in different countries via defining special characters on the KP-200 series portable LCD keyboard (option).

### Syntax

**COUNTRY n**

| <u>Parameter</u> | <u>Description</u>           |
|------------------|------------------------------|
| n                | 001: USA                     |
|                  | 002: Canadian-French         |
|                  | 003: Spanish (Latin America) |
|                  | 031: Dutch                   |
|                  | 032: Belgian                 |
|                  | 033: French (France)         |
|                  | 034: Spanish (Spain)         |
|                  | 036: Hungarian               |
|                  | 038: Yugoslavian             |
|                  | 039: Italian                 |
|                  | 041: Switzerland             |
|                  | 042: Slovak                  |
|                  | 044: United Kingdom          |
|                  | 045: Danish                  |
|                  | 046: Swedish                 |
|                  | 047: Norwegian               |
|                  | 048: Polish                  |
|                  | 049: German                  |
|                  | 055: Brazil                  |
|                  | 061: English (International) |
|                  | 351: Portuguese              |
|                  | 358: Finnish                 |

### Example

#### Sample Code

```
COUNTRY 001
```

### See Also

CODEPAGE, ~!!

## ● CODEPAGE

### Description

This command defines the code page of international character set.

### Syntax

CODEPAGE n

| <u>Parameter</u> |         | <u>Description</u>  |                 |                   |                          |                |          |
|------------------|---------|---|-----------------|-------------------|--------------------------|----------------|----------|
| n                |         | Name or number of code page, which can be divided into 7-bit code page and 8-bit code page. |                 |                   |                          |                |          |
| 7-bit code page  |         | 8-bit code page   |                 | Windows code page |                          | ISO code page  |          |
| n                | Name    | n   | Name            | n                 | Name                     | n              | Name     |
| <b>USA</b>       | USA     | <b>437</b>  | United States   | <b>1250</b>       | Central Europe           | <b>8859-1</b>  | Latin 1  |
| <b>BRI</b>       | British | <b>737</b>  | Greek           | <b>1251</b>       | Cyrillic                 | <b>8859-2</b>  | Latin 2  |
| <b>GER</b>       | German  | <b>850</b>  | Multilingual    | <b>1252</b>       | Latin I                  | <b>8859-3</b>  | Latin 3  |
| <b>FRE</b>       | French  | <b>851</b>  | Greek 1         | <b>1253</b>       | Greek                    | <b>8859-4</b>  | Baltic   |
| <b>DAN</b>       | Danish  | <b>852</b>  | Slavic          | <b>1254</b>       | Turkish                  | <b>8859-5</b>  | Cyrillic |
| <b>ITA</b>       | Italian | <b>855</b>  | Cyrillic        | <b>1255</b>       | Hebrew                   | <b>8859-6</b>  | Arabic   |
| <b>SPA</b>       | Spanish | <b>857</b>  | Turkish         | <b>1256</b>       | Arabic                   | <b>8859-7</b>  | Greek    |
| <b>SWE</b>       | Swedish | <b>860</b>  | Portuguese      | <b>1257</b>       | Baltic                   | <b>8859-8</b>  | Hebrew   |
| <b>SWI</b>       | Swiss   | <b>861</b>  | Icelandic       | <b>1258</b>       | Vietnam                  | <b>8859-9</b>  | Turkish  |
|                  |         | <b>862</b>  | Hebrew          | <b>932</b>        | Japanese Shift-JIS       | <b>8859-10</b> | Latin 6  |
|                  |         | <b>863</b>  | Canadian/French | <b>936</b>        | Simplified Chinese GBK   | <b>8859-15</b> | Latin 9  |
|                  |         | <b>864</b>  | Arabic          | <b>949</b>        | Korean                   |                |          |
|                  |         | <b>865</b>  | Nordic          | <b>950</b>        | Traditional Chinese Big5 |                |          |
|                  |         | <b>866</b>  | Russian         | <b>UTF-8</b>      | UTF 8                    |                |          |
|                  |         | <b>869</b>  | Greek 2         |                   |                          |                |          |

**Note:**  
*DATA LENGTH determines 7-bit or 8-bit communications parameter.*

### Example

#### Download the COUR.TTF into printer by DiagTool

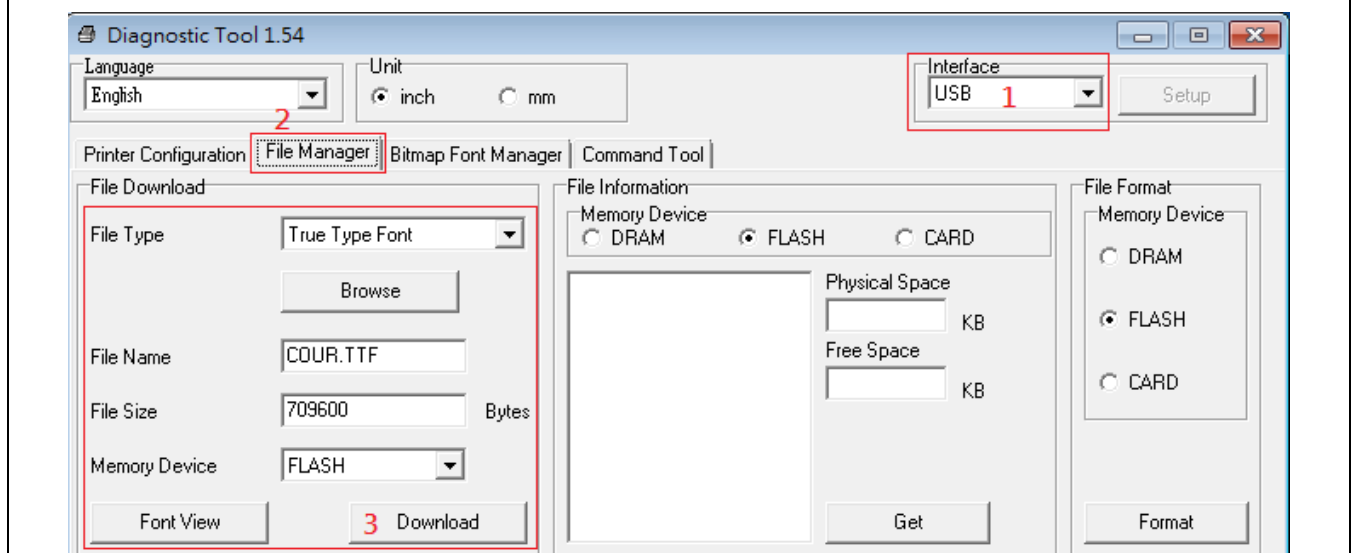

| Sample Code   | Result  |
|---|---|
| <pre> <b>DOWNLOAD "TEST.BAS"</b>  str1\$ = " " J = 0 y = 50  <b>CODEPAGE 1252</b> <b>SIZE 4,3</b> <b>GAP 0,0</b> <b>DIRECTION 1</b> <b>CLS</b> <b>TEXT 10,10,"COUR.TTF",0,12,12,"CODEPAGE 1252"</b> <b>FOR I=32 TO 255</b> str1\$=str1\$+CHR\$(I) + " " J=J+1 <b>IF J=16 THEN GOSUB drawTEXT</b> <b>NEXT</b>  <b>PRINT 1</b> <b>END</b>  drawTEXT: <b>TEXT 10,y,"COUR.TTF",0,12,12,str1\$</b> str1\$=" " J=0 y=y+40 <b>RETURN</b> <b>EOP</b> <b>TEST</b> </pre> | <pre> CODEPAGE 1252 ! " # \$ % &amp; ' ( ) * + , - . / 0 1 2 3 4 5 6 7 8 9 : ; &lt; = &gt; ? @ A B C D E F G H I J K L M N O P Q R S T U V W X Y Z [ \ ] ^ _ ` a b c d e f g h i j k l m n o p q r s t u v w x y z {   } ~ € , f " ... † ‡ ^ % Š &lt; Œ Ž \ / " " • - - ~ ™ š &gt; œ ž Ÿ ı ç £ ¤ ¥ ¦ § ¨ © ª « ¬ - ® ¯ ° ± ² ³ ´ µ ¶ · ¸ ¹ º » ¼ ½ ¾ ¿ À Á Â Ã Ä Å Æ Ç È É Ê Ë Ì Í Î Ï Ð Ñ Ò Ó Ô Õ Ö × Ø Ù Ú Û Ü Ý Þ ß à á â ã ä å æ ç è é ê ë ì í î ï ð ñ ò ó ô õ ö ÷ ø ù ú û ü ý þ ÿ </pre> |

**See Also**

COUNTRY, ~!l

## ● CLS

### Description

This command clears the image buffer.

### Syntax

**CLS**

| <u>Parameter</u> | <u>Description</u> |
|------------------|--------------------|
| None             | N/A                |

**Note:**

*This command must be placed after SIZE command.*

### Example

**Sample code**

```
CLS
```

### See Also

SIZE, GAP, BLINE



## ● FEED

### Description

This command feeds label with the specified length. The length is specified by dot.

### Syntax

**FEED n**

| <u>Parameter</u> | <u>Description</u>                |
|------------------|-----------------------------------|
| n                | unit: dot<br>$1 \leq n \leq 9999$ |

**Note:**  
*200 DPI: 1 mm = 8 dots*  
*300 DPI: 1 mm = 12 dots*

### Example

| <u>Sample code</u> |
|--------------------|
| <b>FEED 40</b>     |

### See Also

BACKFEED, SIZE, GAP, BLINE, HOME, FORMFEED

## ● BACKFEED & BACKUP

### Description

This command feeds the label in reverse. The length is specified by dot.

### Syntax

|                   |                     |
|-------------------|---------------------|
| <b>BACKUP n</b>   | TSPL printers only  |
| <b>BACKFEED n</b> | TSPL2 printers only |

Note: Please refer to [printer model list](#) for checking TSPL or TSPL2.

| <u>Parameter</u> | <u>Description</u>                |
|------------------|-----------------------------------|
| n                | unit: dot<br>$1 \leq n \leq 9999$ |

**Note:**  
**200 DPI: 1 mm = 8 dots**  
**300 DPI: 1 mm = 12 dots**

**CAUTION:**  
***Improprity back feed value may cause paper jam or wrinkle.***

### Example

| <b>Sample code</b>                     |
|--|
| • TSPL printers<br><b>BACKUP 40</b>    |
| • TSPL2 printers<br><b>BACKFEED 40</b> |

### See Also

FEED, SIZE, GAP, BLINE, HOME, FORMFEED

## ● FORMFEED

### Description

This command feeds label to the beginning of next label.

### Syntax

**FORMFEED**

| <u>Parameter</u> | <u>Description</u> |
|------------------|--------------------|
| None             | N/A                |

**Note:**  
*This command must be placed after SIZE command.*

### Example

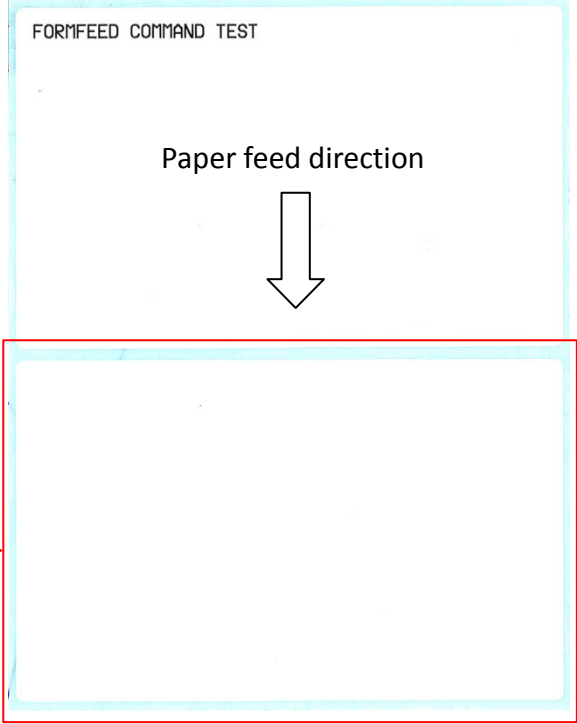
| Sample code  | Result  |
|--|---|
| <pre>SIZE 4,2.5 GAP 2 mm,0 DIRECTION 1 FORMFEED CLS TEXT 25,25, "3",0,1,1, "FORMFEED COMMAND TEST" PRINT 1,1</pre> |  |

### See Also

FEED, SIZE, GAP, BLINE, HOME, BACKFEED

## ● HOME

### Description

This command will feed label until the internal sensor has determined the origin. Size and gap of the label should be defined before using this command.

### Syntax

HOME

| <u>Parameter</u>  | <u>Description</u> |
|---|--------------------|
| None  | N/A                |
| For TSPL programming printer: Back label to origin position<br>For TSPL2 programming printer: Feed label to origin position |                    |
| Note: Please refer to <a href="#">printer model list</a> for checking TSPL or TSPL2.  |                    |

### Example

**Sample code**

```
SIZE 4,2.5
GAP 2 mm,0
SET COUNTER @0 +1
@0="000001"
HOME
CLS
BOX 1,1,360,65,12
TEXT 25,25, "3",0,1,1, "HOME COMMAND TEST"
TEXT 25,80, "3",0,1,1,@0
PRINT 3,1
```

### See Also

FEED, SIZE, GAP, BLINE, FORMFEED

## ● PRINT

### Description

This command prints the label format currently stored in the image buffer.

### Syntax

**PRINT** m[,n]

| <u>Parameter</u> | <u>Description</u>  |
|------------------|---|
| m                | Specifies how many sets of labels will be printed.<br>$1 \leq m \leq 999999999$                         |
| n                | Specifies how many copies should be printed for each particular label set.<br>$1 \leq n \leq 999999999$ |

### Example

| <u>Sample code</u>   | <u>Result</u>  |
|--|--|
| <pre>SIZE 50 mm,25 mm GAP 3 mm,0 DIRECTION 1 SET COUNTER @1 1 @1="0001" CLS TEXT 10,10, "3",0,1,1,@1 PRINT 3,2</pre> | <p>0003</p> <p>0003</p> <p>0002</p> <p>0002</p> <p>0001</p> <p>0001</p> <p>1 set, 2 copies</p> <p>Paper feed direction</p> |

### See Also

SET COUNTER, INPUT, DOWNLOAD

## ● SOUND

### Description

This command controls the sound frequency of the beeper. There are 10 levels of sounds. The timing control can be set by the "interval" parameter.

### Syntax

**SOUND level,interval**

| <u>Parameter</u> | <u>Description</u>     |
|------------------|------------------------|
| level            | Sound level: 0~9       |
| interval         | Sound interval: 1~4095 |

### Example

#### Sample code

- **SOUND 5,200**
- **SOUND 3,200**
- **SOUND 3,200**
- **SOUND 4,200**
- **SOUND 2,200**
- **SOUND 2,200**
- **SOUND 1,200**
- **SOUND 2,200**
- **SOUND 3,200**
- **SOUND 4,200**
- **SOUND 5,200**

## ● CUT

### Description

This command activates the cutter to immediately cut the labels without back feeding the label.

### Syntax

**CUT**

| <u>Parameter</u> | <u>Description</u> |
|------------------|--------------------|
| None             | N/A                |

### Example

#### Sample code

```
SIZE 3,3  
GAP 0,0  
CLS  
BOX 0,0,866,866,5  
TEXT 100,100, "5",0,1,1, "FEED & CUT"  
TEXT 100,200, "5",0,1,1, "300 DPI"  
PRINT 1,1  
FEED 260  
CUT
```

### See Also

SET CUTTER, SET BACK, SET PARTIAL\_CUTTER

## ● LIMITFEED

### Description

If the gap sensor is not set to a suitable sensitivity while feeding labels, the printer will not be able to locate the correct position of the gap. This command stops label feeding and makes the red LED flash if the printer does not locate gap after feeding the length of one label plus one preset value.

### Syntax

|  |   |
|--|---|
| <b>LIMITFEED n[,minpaper,maxgap]</b>             | English system (inch)   |
| <b>LIMITFEED n mm[,minpaper mm,maxgap mm]</b>    | Metric system (mm)  |
| <b>LIMITFEED n dot[,minpaper dot,maxgap dot]</b> | Dot measurement<br><i>This command has been supported since V6.34 EZ.</i> |

| <u>Parameter</u> | <u>Description</u>                      |
|------------------|---|
| N                | The maximum length for sensor detecting |
| Minpaper         | The minimum length of paper             |
| Maxgap           | The maximum length of gap               |

**Note:**

- *The setting will remain resident in memory.*
- *For metric system, there must be a space between parameter n and mm.*
- *The default value is 10 inches when printer initializes.*
- *Since V6.76 EZ, the default value for TDP-225 series printer is 14 inches when printer initializes.*
- *The setting of parameters "mimpaper" and "maxgap" are using for calibrating the preprinted label. This parameter has been supported since V6.98.7 EZ.*

### Example

#### Sample code

- English system (inch)  
**LIMITFEED 12**



## ● SELFTEST

### Description

At this command, the printer will print out the printer information.

### Syntax

SELFTEST [page]

| <u>Parameter</u> | <u>Description</u>  |
|------------------|---|
| page             | <p><b>omitted:</b> Print a self-test page with whole printer information.</p> <p><b>PATTERN:</b> Print a pattern to check the status of print head heat line.</p> <p><b>ETHERNET:</b> Print a self-test page with Ethernet settings.</p> <p><b>WLAN:</b> Print a self-test page with Wi-Fi settings.</p> <p><b>RS232:</b> Print a self-test page with RS-232 settings.</p> <p><b>SYSTEM:</b> Print a self-test page with printer settings.</p> <p><b>Z:</b> Print a self-test page with emulated language settings.</p> <p><b>BT:</b> Print a self-test page with Bluetooth settings.</p> |

### Example

| <u>Sample code</u> | <u>Result</u>  |
|--------------------|--|
| SELFTEST           | <pre> ----- SYSTEM INFORMATION ----- MODEL: TDP247 FIRMWARE: 7.00 EZ CHECKSUM: 07CBD355 S/N: D452350388 TCF: NO DATE: 1970/01/01 TIME: 00:04:18 NON-RESET: 110 m (TPH) RESET: 110 m (TPH) NON-RESET: 0 (CUT) RESET: 0 (CUT) -----  PRINTING SETTING ----- SPEED: 5 IPS DENSITY: 8.0 WIDTH: 4.00 INCH HEIGHT: 4.00 INCH GAP: 0.00 INCH INTENSION: 5 CODEPAGE: 850 COUNTRY: 001 -----  Z SETTING ----- DARKNESS: 16.0 SPEED: 4 IPS WIDTH: 4.00 INCH TILDE: 7EH (")  CARET: 5EH (^) DELIMITER: 2CH (,) POWER UP: NO MOTION HEAD CLOSE: NO MOTION -----  RS232 SETTING ----- BAUD: 9600 PARITY: NONE DATA BIT: 8 STOP BIT: 1 -----  DRAM FILE (0 FILES) ----- PHYSICAL 8192 KBYTES AVAILABLE 256 KBYTES -----  FLASH FILE (0 FILES) ----- PHYSICAL 4096 KBYTES AVAILABLE 2560 KBYTES ----- </pre>  |

|                   |   |
|-------------------|---|
| SELFTEST PATTERN  |   |
| SELFTEST ETHERNET | <pre> ----- ETHERNET SETTING ----- NAME: PS-FF02FD MAC ADDR: 001B82-FF02FD  DHCP: ON IP ADDR: 10.0.10.115 SUBNET: 255.255.255.0 GATEWAY: 10.0.10.252 PORT: 9100 ----- </pre>  |
| SELFTEST WLAN     | <pre> ----- WLAN SETTING ----- MAC ADDR: 001DC9-908397 MODE: AD-HOC SSID: TEST-AP IP ADDR: 192.168.1.3 SUBNET: 255.255.255.0 GATEWAY: 192.168.1.1 PORT: 9100 ----- </pre>   |
| SELFTEST RS232    | <pre> ----- RS232 SETTING ----- BAUD: 9600 PARITY: NONE DATA BIT: 8 STOP BIT: 1 ----- </pre>  |
| SELFTEST SYSTEM   | <pre> ----- SYSTEM INFORMATION ----- MODEL: TDP247 FIRMWARE: 7.00 EZ CHECKSUM: 07CBD355 S/N: D452350388 TCF: NO  DATE: 2013/01/11 TIME: 14:57:55 NON-RESET: 145 m (TPH) RESET: 145 m (TPH) NON-RESET: 0 (CUT) RESET: 0 (CUT) ----- </pre> |
| SELFTEST PRINTER  | <pre> ----- PRINTING SETTING ----- SPEED: 5 IPS DENSITY: 8.0 WIDTH: 4.00 INCH HEIGHT: 1.00 INCH GAP: 0.00 INCH  INTENSION: 5 CODEPAGE: 850 COUNTRY: 001 ----- </pre>  |
| SELFTEST Z        | <pre> ----- Z SETTING ----- DARKNESS: 16.0 SPEED: 4 IPS WIDTH: 4.00 INCH TILDE: 7EH (~) CARET: 5EH (^)  DELIMITER: 2CH (,) POWER UP: NO MOTION HEAD CLOSE: NO MOTION ----- </pre>   |

## ● EOJ

### Description

Let the printer wait until process of commands (before EOJ) be finished then go on the next command.

### Syntax

EOJ

#### Note:

*This command has been supported since V6.39 EZ and later firmware.*

### Example

#### Sample Code

```
SIZE 4,0.2
GAP 0,0
DIRECTION 1
CLS
TEXT 10,10,"3",0,1,1,"Two labels are printed without stop."
PRINT 1
PRINT 1

SIZE 4,0.2
GAP 0,0
CLS
TEXT 10,10,"3",0,1,1,"Printer stops before next printing."
PRINT 1
EOJ
PRINT 1
```

#### Result

Paper feed direction

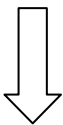

```
Printer stops before next printing.
Printer stops before next printing.
Two labels are printed without stop.
Two labels are printed without stop. } without stop
```

## ● DELAY

### Description

Let the printer wait specific period of time then go on next command.

### Syntax

**DELAY** ms

| <u>Parameter</u>  | <u>Description</u>  |
|---|---|
| ms  | The specific period of time. Unit is millisecond. 1000 ms = 1 second. |
| <b>Note:</b><br><i>This command has been supported since V6.34 EZ and later firmware.</i> |   |

### Example

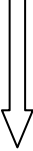
| <u>Sample Code</u>  |
|---|
| <pre>SIZE 4,0.7 GAP 0,0 DIRECTION 1 CLS TEXT 10,10,"3",0,1,1,"The delay time between two labels is 3 seconds." TEXT 10,60,"3",0,1,1,"Now second:" +@SECOND PRINT 1 DELAY 3000 PRINT 1</pre>                               |
| <u>Result</u>   |
|  <pre>The delay time between two labels is 3 seconds. Now second:9  The delay time between two labels is 3 seconds. Now second:6</pre> |

## ● DISPLAY

### Description

This command can show the image, which is in printer's image buffer, on LCD panel.

### Syntax

**DISPLAY IMAGE/OFF/CLS/forecolor,backcolor/x,y,width,height/x,y, "bmpfile"/x,y, "font", "content"**

| <u>Parameter</u>     | <u>Description</u>  |
|----------------------|---|
| IMAGE                | Show the image in printer's image buffer on LCD panel. (since V6.39 EZ)                                 |
| OFF                  | Disable this function. (since V6.39 EZ)   |
| CLS                  | Show the background color and clear the items in printer's image buffer on LCD panel (since A1.90 EZ)   |
| forecolor,backcolor  | Set the color (decimal) for item and background in printer's image buffer on LCD panel (since A1.90 EZ) |
| x,y,width,height     | Draw the bar in printer's image buffer on LCD panel (since A1.90 EZ)                                    |
| x,y,"bmpfile"        | Show the .bmp in printer's image buffer on LCD panel (since A1.90 EZ)                                   |
| x,y,"font","content" | Show the text in printer's image buffer on LCD panel (since A1.90 EZ)                                   |

|           |  |
|-----------|--|
| forecolor | RGB color code for text or bar (decimal) |
| backcolor | RGB color code for background (decimal)  |
| x         | Horizontal multiplication                |
| y         | Vertical multiplication                  |
| width     | frame width                              |
| height    | frame height                             |
| bmpfile   | .bmp file name                           |
| font      | Font name                                |
| content   | Content of text string                   |

**Note:**  
*This command only can be performed on the printer with LCD display.*

### Example

| <u>Sample code</u>  | <u>Result</u>  |
|---|--|
| <pre>CLS TEXT 1,10, "1",0,1,1, "Image on LCD" TEXT 1,30, "1",0,1,1, "1234567890" DISPLAY IMAGE DELAY 5000 DISPLAY OFF</pre> |  |

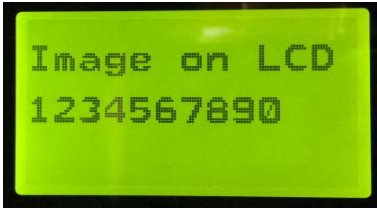
CLS  
DISPLAY 15128749,16711680  
DISPLAY CLS  
DISPLAY 10,30, "1","1234567890"  
DELAY 5000  
DISPLAY OFF



## ● INITIALPRINTER

### Description

This command can restore printer settings to defaults.

### Syntax

**INITIALPRINTER**

| <u>Parameter</u> | <u>Description</u> |
|------------------|--------------------|
| None             | N/A                |

### Example

#### Sample code

```
INITIALPRINTER
```

## ● MENU

### Description

This command can design user's own menu with a database resident on the printer.

### Syntax

**MENU title\$, list\$, selected**

| <u>Parameter</u> | <u>Description</u>  |
|------------------|---|
| title\$          | The title string is shown on LCD screen.  |
| list\$           | List of items, separated by CRLF.   |
| selected         | It must be a variable to get the result of selection. When selected is 0, the operator has hit ESC (USB keyboard) or MENU button. |

**Note:**

- This command only can be performed on the printer with LCD display.
- This command has been supported since VA1.97 and later firmware.

### Example

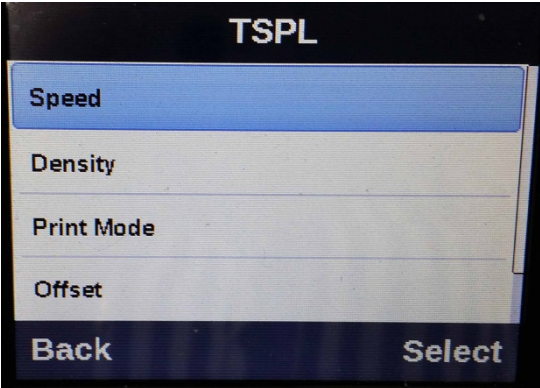
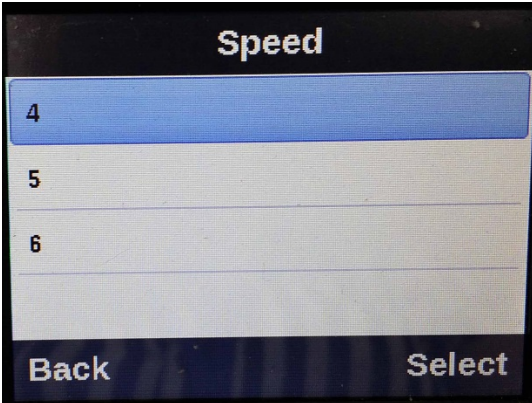
| <u>Sample code</u>  | <u>Result</u>  |
|---|--|
| <pre>DOWNLOAD F,"TSPL" Speed Density Print Mode Offset Country EOP  DOWNLOAD F,"Speed" 4 5 6 EOP  DOWNLOAD F,"Density" 6 7 8 9 10 11 12 EOP  DOWNLOAD F,"Print Mode" NONE TEAR OFF PEEL OFF CUT OFF EOP  DOWNLOAD F,"Country" 007 031 033 034 045</pre> | <br> |



```

EOP

DOWNLOAD F,"DEMO.BAS"

DPI = VAL(GETSETTING$("SYSTEM","INFORMATION","DPI"))

:MAINLOOP
OPEN "TSPL",0
LIST$ = FREAD$(0, LOF("TSPL"))
CLOSE 0
MENU "TSPL", LIST$, OPTION$

IF LEN(OPTION$) = 0 THEN END

IF OPTION$ = "Speed" THEN SETTING$ =
GETSETTING$("CONFIG","TSPL","SPEED")
IF OPTION$ = "Density" THEN SETTING$ =
GETSETTING$("CONFIG","TSPL","DENSITY")
IF OPTION$ = "Print Mode" THEN SETTING$ =
GETSETTING$("CONFIG","TSPL","PRINT MODE")
IF OPTION$ = "Offset" THEN SETTING$ =
GETSETTING$("CONFIG","TSPL","OFFSET")
IF OPTION$ = "Country" THEN SETTING$ =
GETSETTING$("CONFIG","TSPL","COUNTRY CODE")

IF LOF(OPTION$) <> 0 THEN
OPEN OPTION$,0
LIST$ = FREAD$(0, LOF(OPTION$))
CLOSE 0
MENU OPTION$, LIST$, SETTING$
ELSE
IF OPTION$ = "Offset" THEN INPUT "Offset", SETTING$
ENDIF

IF LEN(SETTING$) <> 0 THEN
IF OPTION$ = "Speed" THEN SPEED VAL(SETTING$)
IF OPTION$ = "Density" THEN DENSITY VAL(SETTING$)
IF OPTION$ = "Print Mode" THEN GOSUB SET_PRINT_MODE
IF OPTION$ = "Offset" THEN OFFSET VAL(SETTING$) / DPI
IF OPTION$ = "Country" THEN GOSUB SET_COUNTRY
ENDIF

GOTO MAINLOOP

:SET_PRINT_MODE
IF SETTING$ = "NONE" THEN SET TEAR OFF
IF SETTING$ = "TEAR OFF" THEN SET TEAR ON
IF SETTING$ = "PEEL OFF" THEN SET PEEL ON
IF SETTING$ = "CUT OFF" THEN SET CUTTER ON
RETURN

:SET_COUNTRY
IF SETTING$ = "007" THEN COUNTRY 007
IF SETTING$ = "031" THEN COUNTRY 031
IF SETTING$ = "033" THEN COUNTRY 033
IF SETTING$ = "034" THEN COUNTRY 034
IF SETTING$ = "045" THEN COUNTRY 045
RETURN

EOP

RUN "DEMO.BAS"

```

# Label Formatting Commands

## ● BAR

### Description

This command draws a bar on the label format.

### Syntax

**BAR x,y,width,height**

| <u>Parameter</u> | <u>Description</u>                           |
|------------------|--|
| x                | The upper left corner x-coordinate (in dots) |
| y                | The upper left corner y-coordinate (in dots) |
| width            | Bar width (in dots)                          |
| height           | Bar height (in dots)                         |

**Note:**

- **200 DPI : 1 mm = 8 dots**  
**300 DPI : 1 mm = 12 dots**
- **Recommended max. bar height is 12 mm at 4" width. Bar height over 12 mm may damage the power supply and affect the print quality.**
- **Max. print ratio is different for each printer model. Desktop and industrial printer print ratio is limited to 20% and 30% respectively.**

### Example

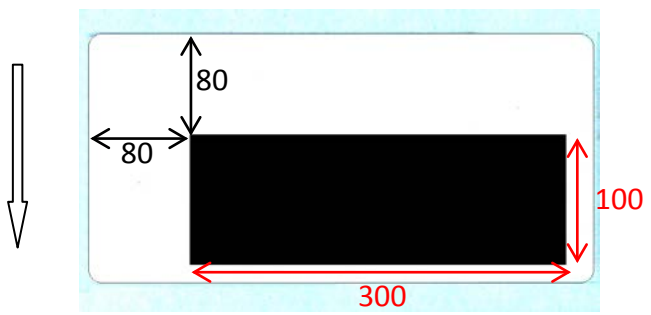
| <u>Sample code</u>   | <u>Result</u>  |
|--|--|
| <pre>SIZE 50 mm,25 mm GAP 3 mm,0 DIRECTION 1 CLS BAR 80,80,300,100 PRINT 1,1</pre> |  |

### See Also

BOX

## ● BARCODE

### Description

This command prints 1D barcodes. The available barcodes are listed below:

| Code Type       | Description  | Narrow : Width |     |     |     |     | Max. data length |
|-----------------|--|----------------|-----|-----|-----|-----|------------------|
|                 |  | 1:1            | 1:2 | 1:3 | 2:5 | 3:7 |                  |
| <b>128</b>      | Code 128, switching code subset automatically.                 | V              |     |     |     |     |                  |
| <b>128M</b>     | Code 128, switching code subset manually.                      | V              |     |     |     |     |                  |
| <b>EAN128</b>   | EAN128, switching code subset automatically.                   | V              |     |     |     |     |                  |
| <b>EAN128M</b>  | EAN128M, switching code subset automatically.                  | V              |     |     |     |     |                  |
| <b>25</b>       | Interleaved 2 of 5.  |                | V   | V   | V   |     | Length is even   |
| <b>25C</b>      | Interleaved 2 of 5 with check digit.                           |                | V   | V   | V   |     | Length is odd    |
| <b>25S</b>      | Standard 2 of 5.   |                | V   | V   | V   |     |                  |
| <b>25I</b>      | Industrial 2 of 5.   |                | V   | V   | V   |     |                  |
| <b>39</b>       | Code 39, switching standard and full ASCII mode automatically. |                | V   | V   | V   |     |                  |
| <b>39C</b>      | Code 39 with check digit.                                      |                | V   | V   | V   |     |                  |
| <b>93</b>       | Code 93.   |                |     | V   |     |     |                  |
| <b>EAN13</b>    | EAN 13.  | V              |     |     |     |     | 12               |
| <b>EAN13+2</b>  | EAN 13 with 2 digits add-on.                                   | V              |     |     |     |     | 14               |
| <b>EAN13+5</b>  | EAN 13 with 5 digits add-on.                                   | V              |     |     |     |     | 17               |
| <b>EAN8</b>     | EAN 8.   | V              |     |     |     |     | 7                |
| <b>EAN8+2</b>   | EAN 8 with 2 digits add-on.                                    | V              |     |     |     |     | 9                |
| <b>EAN8+5</b>   | EAN 8 with 5 digits add-on.                                    | V              |     |     |     |     | 12               |
| <b>CODA</b>     | Codabar.   |                | V   | V   | V   |     |                  |
| <b>POST</b>     | Postnet.   | V              |     |     |     |     | 5, 9, 11         |
| <b>UPCA</b>     | UPC-A.   | V              |     |     |     |     | 11               |
| <b>UPCA+2</b>   | UPC-A with 2 digits add-on.                                    | V              |     |     |     |     | 13               |
| <b>UPA+5</b>    | UPC-A with 5 digits add-on.                                    | V              |     |     |     |     | 16               |
| <b>UPCE</b>     | UPC-E.   | V              |     |     |     |     | 6                |
| <b>UPCE+2</b>   | UPC-E with 2 digits add-on.                                    | V              |     |     |     |     | 8                |
| <b>UPE+5</b>    | UPC-E with 5 digits add-on.                                    | V              |     |     |     |     | 11               |
| <b>MSI</b>      | MSI.   |                | V   | V   | V   |     |                  |
| <b>MSIC</b>     | MSI with check digit.  |                | V   | V   | V   |     |                  |
| <b>PLESSEY</b>  | PLESSEY.   |                | V   | V   | V   |     |                  |
| <b>CPOST</b>    | China post.  |                |     |     |     | V   |                  |
| <b>ITF14</b>    | ITF14.   |                | V   | V   | V   |     | 13               |
| <b>EAN14</b>    | EAN14.   | V              |     |     |     |     | 13               |
| <b>11</b>       | Code 11.   |                | V   | V   | V   |     |                  |
| <b>TELEPEN</b>  | Telepen. <i>*Since V6.89EZ.</i>                                |                | V   | V   | V   |     |                  |
| <b>TELEPENN</b> | Telepen number. <i>*Since V6.89EZ.</i>                         |                | V   | V   | V   |     |                  |
| <b>PLANET</b>   | Planet. <i>*Since V6.89EZ.</i>                                 | V              |     |     |     |     |                  |
| <b>CODE49</b>   | Code 49. <i>*Since V6.89EZ.</i>                                | V              |     |     |     |     |                  |
| <b>DPI</b>      | Deutsche Post Identcode. <i>*Since V6.91EZ.</i>                |                | V   | V   | V   |     | 11               |
| <b>DPL</b>      | Deutsche Post Leitcode. <i>*Since V6.91EZ.</i>                 |                | V   | V   | V   |     | 13               |
| <b>LOGMARS</b>  | A special use of Code 39. <i>*Since V6.88EZ.</i>               |                | V   | V   | V   |     |                  |

## Syntax

BARCODE X,Y, "code type",height,human readable,rotation,narrow,wide,[alignment,] "content "

| Parameter    | Description   |              |        |   |   |     |      |      |      |     |      |      |      |     |       |       |      |     |        |        |      |     |        |      |        |     |      |        |        |     |      |      |      |     |                |  |  |     |                |  |  |     |                |  |  |
|--------------|---|--------------|--------|---|---|-----|------|------|------|-----|------|------|------|-----|-------|-------|------|-----|--------|--------|------|-----|--------|------|--------|-----|------|--------|--------|-----|------|------|------|-----|----------------|--|--|-----|----------------|--|--|-----|----------------|--|--|
| X            | Specify the x-coordinate bar code on the label  |              |        |   |   |     |      |      |      |     |      |      |      |     |       |       |      |     |        |        |      |     |        |      |        |     |      |        |        |     |      |      |      |     |                |  |  |     |                |  |  |     |                |  |  |
| Y            | Specify the y-coordinate bar code on the label  |              |        |   |   |     |      |      |      |     |      |      |      |     |       |       |      |     |        |        |      |     |        |      |        |     |      |        |        |     |      |      |      |     |                |  |  |     |                |  |  |     |                |  |  |
| code type    |   |              |        |   |   |     |      |      |      |     |      |      |      |     |       |       |      |     |        |        |      |     |        |      |        |     |      |        |        |     |      |      |      |     |                |  |  |     |                |  |  |     |                |  |  |
| 128          | Code 128, switching code subset A, B, C automatically   |              |        |   |   |     |      |      |      |     |      |      |      |     |       |       |      |     |        |        |      |     |        |      |        |     |      |        |        |     |      |      |      |     |                |  |  |     |                |  |  |     |                |  |  |
| 128M         | Code 128, switching code subset A, B, C manually <table border="1" data-bbox="470 443 1109 790"> <thead> <tr> <th>Control code</th> <th>A</th> <th>B</th> <th>C</th> </tr> </thead> <tbody> <tr> <td>096</td> <td>FNC3</td> <td>FNC3</td> <td>NONE</td> </tr> <tr> <td>097</td> <td>FNC2</td> <td>FNC2</td> <td>NONE</td> </tr> <tr> <td>098</td> <td>SHIFT</td> <td>SHIFT</td> <td>NONE</td> </tr> <tr> <td>099</td> <td>CODE C</td> <td>CODE C</td> <td>NONE</td> </tr> <tr> <td>100</td> <td>CODE B</td> <td>FNC4</td> <td>CODE B</td> </tr> <tr> <td>101</td> <td>FNC4</td> <td>CODE A</td> <td>CODE A</td> </tr> <tr> <td>102</td> <td>FNC1</td> <td>FNC1</td> <td>FNC1</td> </tr> <tr> <td>103</td> <td colspan="3">Start (CODE A)</td> </tr> <tr> <td>104</td> <td colspan="3">Start (CODE B)</td> </tr> <tr> <td>105</td> <td colspan="3">Start (CODE C)</td> </tr> </tbody> </table> <p><i>Use "!" as a starting character for the control code followed by three control codes. If the start subset is not set, the default starting subset is B.</i></p> | Control code | A      | B | C | 096 | FNC3 | FNC3 | NONE | 097 | FNC2 | FNC2 | NONE | 098 | SHIFT | SHIFT | NONE | 099 | CODE C | CODE C | NONE | 100 | CODE B | FNC4 | CODE B | 101 | FNC4 | CODE A | CODE A | 102 | FNC1 | FNC1 | FNC1 | 103 | Start (CODE A) |  |  | 104 | Start (CODE B) |  |  | 105 | Start (CODE C) |  |  |
| Control code | A   | B            | C      |   |   |     |      |      |      |     |      |      |      |     |       |       |      |     |        |        |      |     |        |      |        |     |      |        |        |     |      |      |      |     |                |  |  |     |                |  |  |     |                |  |  |
| 096          | FNC3  | FNC3         | NONE   |   |   |     |      |      |      |     |      |      |      |     |       |       |      |     |        |        |      |     |        |      |        |     |      |        |        |     |      |      |      |     |                |  |  |     |                |  |  |     |                |  |  |
| 097          | FNC2  | FNC2         | NONE   |   |   |     |      |      |      |     |      |      |      |     |       |       |      |     |        |        |      |     |        |      |        |     |      |        |        |     |      |      |      |     |                |  |  |     |                |  |  |     |                |  |  |
| 098          | SHIFT   | SHIFT        | NONE   |   |   |     |      |      |      |     |      |      |      |     |       |       |      |     |        |        |      |     |        |      |        |     |      |        |        |     |      |      |      |     |                |  |  |     |                |  |  |     |                |  |  |
| 099          | CODE C  | CODE C       | NONE   |   |   |     |      |      |      |     |      |      |      |     |       |       |      |     |        |        |      |     |        |      |        |     |      |        |        |     |      |      |      |     |                |  |  |     |                |  |  |     |                |  |  |
| 100          | CODE B  | FNC4         | CODE B |   |   |     |      |      |      |     |      |      |      |     |       |       |      |     |        |        |      |     |        |      |        |     |      |        |        |     |      |      |      |     |                |  |  |     |                |  |  |     |                |  |  |
| 101          | FNC4  | CODE A       | CODE A |   |   |     |      |      |      |     |      |      |      |     |       |       |      |     |        |        |      |     |        |      |        |     |      |        |        |     |      |      |      |     |                |  |  |     |                |  |  |     |                |  |  |
| 102          | FNC1  | FNC1         | FNC1   |   |   |     |      |      |      |     |      |      |      |     |       |       |      |     |        |        |      |     |        |      |        |     |      |        |        |     |      |      |      |     |                |  |  |     |                |  |  |     |                |  |  |
| 103          | Start (CODE A)  |              |        |   |   |     |      |      |      |     |      |      |      |     |       |       |      |     |        |        |      |     |        |      |        |     |      |        |        |     |      |      |      |     |                |  |  |     |                |  |  |     |                |  |  |
| 104          | Start (CODE B)  |              |        |   |   |     |      |      |      |     |      |      |      |     |       |       |      |     |        |        |      |     |        |      |        |     |      |        |        |     |      |      |      |     |                |  |  |     |                |  |  |     |                |  |  |
| 105          | Start (CODE C)  |              |        |   |   |     |      |      |      |     |      |      |      |     |       |       |      |     |        |        |      |     |        |      |        |     |      |        |        |     |      |      |      |     |                |  |  |     |                |  |  |     |                |  |  |
| EAN128       | Code 128, switching code subset A, B, C automatically   |              |        |   |   |     |      |      |      |     |      |      |      |     |       |       |      |     |        |        |      |     |        |      |        |     |      |        |        |     |      |      |      |     |                |  |  |     |                |  |  |     |                |  |  |
| EAN128M      | Code 128, switching code subset A, B, C manually  |              |        |   |   |     |      |      |      |     |      |      |      |     |       |       |      |     |        |        |      |     |        |      |        |     |      |        |        |     |      |      |      |     |                |  |  |     |                |  |  |     |                |  |  |
| 25           | Interleaved 2 of 5  |              |        |   |   |     |      |      |      |     |      |      |      |     |       |       |      |     |        |        |      |     |        |      |        |     |      |        |        |     |      |      |      |     |                |  |  |     |                |  |  |     |                |  |  |
| 25C          | Interleaved 2 of 5 with check digits  |              |        |   |   |     |      |      |      |     |      |      |      |     |       |       |      |     |        |        |      |     |        |      |        |     |      |        |        |     |      |      |      |     |                |  |  |     |                |  |  |     |                |  |  |
| 25S          | Standard 2 of 5   |              |        |   |   |     |      |      |      |     |      |      |      |     |       |       |      |     |        |        |      |     |        |      |        |     |      |        |        |     |      |      |      |     |                |  |  |     |                |  |  |     |                |  |  |
| 25I          | Industrial 2 of 5   |              |        |   |   |     |      |      |      |     |      |      |      |     |       |       |      |     |        |        |      |     |        |      |        |     |      |        |        |     |      |      |      |     |                |  |  |     |                |  |  |     |                |  |  |
| 39           | Code 39 full ASCII for TSPL2 printers<br>Code 39 standard for TSPL printers<br>Auto switch full ASCII and standard code 39 for <b>PLUS</b> models<br><i>Note: Please refer to <a href="#">printer model list</a> for detail.</i>  |              |        |   |   |     |      |      |      |     |      |      |      |     |       |       |      |     |        |        |      |     |        |      |        |     |      |        |        |     |      |      |      |     |                |  |  |     |                |  |  |     |                |  |  |
| 39C          | Code 39 full ASCII with check digit for TSPL2 printers<br>Code 39 standard with check digit for TSPL printers<br>Auto switch full ASCII and standard code 39 for <b>PLUS</b> models<br><i>Note: Please refer to <a href="#">printer model list</a> for detail.</i>  |              |        |   |   |     |      |      |      |     |      |      |      |     |       |       |      |     |        |        |      |     |        |      |        |     |      |        |        |     |      |      |      |     |                |  |  |     |                |  |  |     |                |  |  |
| 39S          | Code 39 standard for TSPL2 printers<br><i>Note: Please refer to <a href="#">printer model list</a> for detail.</i>  |              |        |   |   |     |      |      |      |     |      |      |      |     |       |       |      |     |        |        |      |     |        |      |        |     |      |        |        |     |      |      |      |     |                |  |  |     |                |  |  |     |                |  |  |
| 93           | Code 93   |              |        |   |   |     |      |      |      |     |      |      |      |     |       |       |      |     |        |        |      |     |        |      |        |     |      |        |        |     |      |      |      |     |                |  |  |     |                |  |  |     |                |  |  |
| EAN13        | EAN 13  |              |        |   |   |     |      |      |      |     |      |      |      |     |       |       |      |     |        |        |      |     |        |      |        |     |      |        |        |     |      |      |      |     |                |  |  |     |                |  |  |     |                |  |  |
| EAN13+2      | EAN 13 with 2 digits add-on   |              |        |   |   |     |      |      |      |     |      |      |      |     |       |       |      |     |        |        |      |     |        |      |        |     |      |        |        |     |      |      |      |     |                |  |  |     |                |  |  |     |                |  |  |
| EAN13+5      | EAN 13 with 5 digits add-on   |              |        |   |   |     |      |      |      |     |      |      |      |     |       |       |      |     |        |        |      |     |        |      |        |     |      |        |        |     |      |      |      |     |                |  |  |     |                |  |  |     |                |  |  |
| EAN8         | EAN 8   |              |        |   |   |     |      |      |      |     |      |      |      |     |       |       |      |     |        |        |      |     |        |      |        |     |      |        |        |     |      |      |      |     |                |  |  |     |                |  |  |     |                |  |  |
| EAN8+2       | EAN 8 with 2 digits add-on  |              |        |   |   |     |      |      |      |     |      |      |      |     |       |       |      |     |        |        |      |     |        |      |        |     |      |        |        |     |      |      |      |     |                |  |  |     |                |  |  |     |                |  |  |
| EAN8+5       | EAN 8 with 5 digits add-on  |              |        |   |   |     |      |      |      |     |      |      |      |     |       |       |      |     |        |        |      |     |        |      |        |     |      |        |        |     |      |      |      |     |                |  |  |     |                |  |  |     |                |  |  |
| CODA         | Codabar   |              |        |   |   |     |      |      |      |     |      |      |      |     |       |       |      |     |        |        |      |     |        |      |        |     |      |        |        |     |      |      |      |     |                |  |  |     |                |  |  |     |                |  |  |
| POST         | Postnet   |              |        |   |   |     |      |      |      |     |      |      |      |     |       |       |      |     |        |        |      |     |        |      |        |     |      |        |        |     |      |      |      |     |                |  |  |     |                |  |  |     |                |  |  |
| UPCA         | UPC-A   |              |        |   |   |     |      |      |      |     |      |      |      |     |       |       |      |     |        |        |      |     |        |      |        |     |      |        |        |     |      |      |      |     |                |  |  |     |                |  |  |     |                |  |  |
| UPCA+2       | UPC-A with 2 digits add-on  |              |        |   |   |     |      |      |      |     |      |      |      |     |       |       |      |     |        |        |      |     |        |      |        |     |      |        |        |     |      |      |      |     |                |  |  |     |                |  |  |     |                |  |  |
| UPCA+5       | UPC-A with 5 digits add-on  |              |        |   |   |     |      |      |      |     |      |      |      |     |       |       |      |     |        |        |      |     |        |      |        |     |      |        |        |     |      |      |      |     |                |  |  |     |                |  |  |     |                |  |  |
| UPCE         | UPC-E   |              |        |   |   |     |      |      |      |     |      |      |      |     |       |       |      |     |        |        |      |     |        |      |        |     |      |        |        |     |      |      |      |     |                |  |  |     |                |  |  |     |                |  |  |
| UPCE+2       | UPC-E with 2 digits add-on  |              |        |   |   |     |      |      |      |     |      |      |      |     |       |       |      |     |        |        |      |     |        |      |        |     |      |        |        |     |      |      |      |     |                |  |  |     |                |  |  |     |                |  |  |
| UPCE+5       | UPC-E with 5 digits add-on  |              |        |   |   |     |      |      |      |     |      |      |      |     |       |       |      |     |        |        |      |     |        |      |        |     |      |        |        |     |      |      |      |     |                |  |  |     |                |  |  |     |                |  |  |
| CPOST        | China post code   |              |        |   |   |     |      |      |      |     |      |      |      |     |       |       |      |     |        |        |      |     |        |      |        |     |      |        |        |     |      |      |      |     |                |  |  |     |                |  |  |     |                |  |  |
| MSI          | MSI code  |              |        |   |   |     |      |      |      |     |      |      |      |     |       |       |      |     |        |        |      |     |        |      |        |     |      |        |        |     |      |      |      |     |                |  |  |     |                |  |  |     |                |  |  |

|          |                           |
|----------|---------------------------|
| MSIC     | MSI with check digit      |
| PLESSEY  | PLESSEY code              |
| ITF14    | ITF 14 code               |
| EAN14    | EAN 14 code               |
| 11       | Code 11                   |
| TELEPEN  | Telepen code              |
| TELEPENN | Telepen code. Number only |
| PLANET   | Planet code               |
| CODE49   | Code 49                   |
| DPI      | Deutsche Post Identcode   |
| DPL      | Deutsche Post Leitcode    |

Note:

\* TDP-643 Plus , TTP-243, TTP-342, TTP-244ME and TTP-342M models are not supported MSI, MSIC, PLESSY, ITF14, EAN14 and 11.

\* TTP-248M model are not supported MSIC and 11.

Height  
human readable

Bar code height (in dots)  
0: not readable  
1: human readable aligns to left  
2: human readable aligns to center  
3: human readable aligns to right

rotation

0 : No rotation  
90 : Rotate 90 degrees clockwise  
180 : Rotate 180 degrees clockwise  
270 : Rotate 270 degrees clockwise

narrow  
wide

Width of narrow element (in dots)  
Width of wide element (in dots)

|                | narrow : wide<br>1:1 | narrow : wide<br>1:2 | narrow : wide<br>1:3 | narrow : wide<br>2:5 | narrow : wide<br>3:7 |
|----------------|----------------------|----------------------|----------------------|----------------------|----------------------|
| <b>128</b>     | 10x                  | -                    | -                    | -                    | -                    |
| <b>EAN128</b>  | 10x                  | -                    | -                    | -                    | -                    |
| <b>EAN128M</b> | 10x                  |                      |                      |                      |                      |
| <b>25</b>      | -                    | 10x                  | 10x                  | 5x                   | -                    |
| <b>25C</b>     | -                    | 10x                  | 10x                  | 5x                   | -                    |
| <b>25S</b>     |                      | 10x                  | 10x                  | 5x                   |                      |
| <b>25I</b>     |                      | 10x                  | 10x                  | 5x                   |                      |
| <b>39</b>      | -                    | 10x                  | 10x                  | 5x                   | -                    |
| <b>39C</b>     | -                    | 10x                  | 10x                  | 5x                   | -                    |
| <b>93</b>      | -                    | -                    | 10x                  | -                    | -                    |
| <b>EAN13</b>   | 8x                   | -                    | -                    | -                    | -                    |
| <b>EAN13+2</b> | 8x                   | -                    | -                    | -                    | -                    |
| <b>EAN13+5</b> | 8x                   | -                    | -                    | -                    | -                    |
| <b>EAN 8</b>   | 8x                   | -                    | -                    | -                    | -                    |
| <b>EAN 8+2</b> | 8x                   | -                    | -                    | -                    | -                    |
| <b>EAN 8+5</b> | 8x                   | -                    | -                    | -                    | -                    |
| <b>CODA</b>    | -                    | 10x                  | 10x                  | 5x                   | -                    |
| <b>POST</b>    | 1x                   | -                    | -                    | -                    | -                    |
| <b>UPCA</b>    | 8x                   | -                    | -                    | -                    | -                    |
| <b>UPCA+2</b>  | 8x                   | -                    | -                    | -                    | -                    |
| <b>UPCA+5</b>  | 8x                   | -                    | -                    | -                    | -                    |
| <b>UPCE</b>    | 8x                   | -                    | -                    | -                    | -                    |
| <b>UPCE+2</b>  | 8x                   | -                    | -                    | -                    | -                    |
| <b>UPCE+5</b>  | 8x                   | -                    | -                    | -                    | -                    |
| <b>CPOST</b>   | -                    | -                    | -                    | -                    | 1x                   |
| <b>MSI</b>     | -                    | -                    | 10x                  | -                    | -                    |
| <b>MSIC</b>    |                      |                      | 10x                  |                      |                      |
| <b>PLESSY</b>  | -                    | -                    | 10x                  | -                    | -                    |
| <b>ITF14</b>   | -                    | 10x                  | 10x                  | 5x                   | -                    |

|              |    |     |     |    |   |
|--------------|----|-----|-----|----|---|
| <b>EAN14</b> | 8x | -   | -   | -  | - |
| <b>11</b>    | -  | 10x | 10x | 5x | - |

alignment Specify the alignment of barcode  
0 : default (Left)  
1 : Left  
2 : Center  
3 : Right

content Content of barcode  
**Please note that the maximum number of digits of bar code content.**



| Code Type              | Character sets  | Max. data length |
|------------------------|---|------------------|
| <b>128</b>             | See Character set for CODE128.  | -                |
| <b>128M</b>            | See Character set for CODE128.  | -                |
| <b>EAN128</b>          | See Character set for CODE128.  | -                |
| <b>EAN128M</b>         | See Character set for CODE128.  | -                |
| <b>25</b>              | 0123456789  | Length is even.  |
| <b>25C</b>             | 0123456789  | Length is odd.   |
| <b>25S</b>             | 0123456789  |                  |
| <b>25I</b>             | 0123456789  |                  |
| <b>39 I</b>            | 0123456789[Space]ABCDEFGHIJKLMNOPQRSTUVWXYZ<br>-./+%  | -                |
| <b>39 I Full ASCII</b> | 0123456789[Space]ABCDEFGHIJKLMNOPQRSTUVWXYZ<br>!#\$%&'()*+,-./:;=<?@[\\]^_`abcdefghijklmnopqrstuvwxyz{ }~ | -                |
| <b>93</b>              | 0123456789[Space]ABCDEFGHIJKLMNOPQRSTUVWXYZ<br>!#\$%&'()*+,-./:;=<?@[\\]^_`abcdefghijklmnopqrstuvwxyz{ }~ | -                |
| <b>EAN13</b>           | 0123456789  | 12               |
| <b>EAN13+2</b>         | 0123456789  | 14               |
| <b>EAN13+5</b>         | 0123456789  | 17               |
| <b>EAN8</b>            | 0123456789  | 7                |
| <b>EAN8+2</b>          | 0123456789  | 9                |
| <b>EAN8+5</b>          | 0123456789  | 12               |
| <b>CODA</b>            | 0123456789-\$/+.  | -                |
| <b>POST</b>            | 0123456789  | 5, 9, 11         |
| <b>UPCA</b>            | 0123456789  | 11               |
| <b>UPCA+2</b>          | 0123456789  | 13               |
| <b>UPA+5</b>           | 0123456789  | 16               |
| <b>UPCE</b>            | 0123456789  | 6                |
| <b>UPCE+2</b>          | 0123456789  | 8                |
| <b>UPE+5</b>           | 0123456789  | 11               |
| <b>MSI</b>             | 0123456789  | -                |
| <b>MSIC</b>            | 0123456789  | -                |
| <b>PLESSEY</b>         | 0123456789  | -                |
| <b>CPOST</b>           | 0123456789  | -                |
| <b>ITF14</b>           | 0123456789  | 13               |
| <b>EAN14</b>           | 0123456789  | 13               |
| <b>11</b>              | 0123456789-   | -                |
| <b>TELEPEN</b>         | ASCII 0 to 127  | 30               |
| <b>TELEPENN</b>        | 0123456789  | 60               |
| <b>PLANET</b>          | 0123456789  | 38               |
| <b>CODE49</b>          | ASCII 0 to 127  | 81               |
| <b>DPI</b>             | 0123456789  | 11               |
| <b>DPL</b>             | 0123456789  | 13               |
| <b>LOGMARS</b>         | 0123456789[Space]ABCDEFGHIJKLMNOPQRSTUVWXYZ<br>-./+%  | -                |

**Note:**  
Since V5.10EZ, **\[R]** means carriage return character 0x0D and **\[L]** means line feed character 0x0A.

## Character set for CODE 128

| Value | 128A  | 128B  | 128C | Value | 128A | 128B | 128C | Value | 128A         | 128B    | 128C   |
|-------|-------|-------|------|-------|------|------|------|-------|--------------|---------|--------|
| 0     | space | space | 00   | 36    | D    | D    | 36   | 72    | BS           | h       | 72     |
| 1     | !     | !     | 01   | 37    | E    | E    | 37   | 73    | HT           | i       | 73     |
| 2     | "     | "     | 02   | 38    | F    | F    | 38   | 74    | LF           | j       | 74     |
| 3     | #     | #     | 03   | 39    | G    | G    | 39   | 75    | VT           | k       | 75     |
| 4     | \$    | \$    | 04   | 40    | H    | H    | 40   | 76    | FF           | l       | 76     |
| 5     | %     | %     | 05   | 41    | I    | I    | 41   | 77    | CR           | m       | 77     |
| 6     | &     | &     | 06   | 42    | J    | J    | 42   | 78    | SO           | n       | 78     |
| 7     | '     | '     | 07   | 43    | K    | K    | 43   | 79    | SI           | o       | 79     |
| 8     | (     | (     | 08   | 44    | L    | L    | 44   | 80    | DLE          | p       | 80     |
| 9     | )     | )     | 09   | 45    | M    | M    | 45   | 81    | DC1          | q       | 81     |
| 10    | *     | *     | 10   | 46    | N    | N    | 46   | 82    | DC2          | r       | 82     |
| 11    | +     | +     | 11   | 47    | O    | O    | 47   | 83    | DC3          | s       | 83     |
| 12    | ,     | ,     | 12   | 48    | P    | P    | 48   | 84    | DC4          | t       | 84     |
| 13    | -     | -     | 13   | 49    | Q    | Q    | 49   | 85    | NAK          | u       | 85     |
| 14    | .     | .     | 14   | 50    | R    | R    | 50   | 86    | SYN          | v       | 86     |
| 15    | /     | /     | 15   | 51    | S    | S    | 51   | 87    | ETB          | w       | 87     |
| 16    | 0     | 0     | 16   | 52    | T    | T    | 52   | 88    | CAN          | x       | 88     |
| 17    | 1     | 1     | 17   | 53    | U    | U    | 53   | 89    | EM           | y       | 89     |
| 18    | 2     | 2     | 18   | 54    | V    | V    | 54   | 90    | SUB          | z       | 90     |
| 19    | 3     | 3     | 19   | 55    | W    | W    | 55   | 91    | ESC          | {       | 91     |
| 20    | 4     | 4     | 20   | 56    | X    | X    | 56   | 92    | FS           |         | 92     |
| 21    | 5     | 5     | 21   | 57    | Y    | Y    | 57   | 93    | GS           | }       | 93     |
| 22    | 6     | 6     | 22   | 58    | Z    | Z    | 58   | 94    | RS           | ~       | 94     |
| 23    | 7     | 7     | 23   | 59    | [    | [    | 59   | 95    | US           | DEL     | 95     |
| 24    | 8     | 8     | 24   | 60    | \    | \    | 60   | 96    | FNC 3        | FNC 3   | 96     |
| 25    | 9     | 9     | 25   | 61    | ]    | ]    | 61   | 97    | FNC 2        | FNC 2   | 97     |
| 26    | :     | :     | 26   | 62    | ^    | ^    | 62   | 98    | Shift B      | Shift A | 98     |
| 27    | ;     | ;     | 27   | 63    | _    | _    | 63   | 99    | Code C       | Code C  | 99     |
| 28    | <     | <     | 28   | 64    | NUL  | `    | 64   | 100   | Code B       | FNC4    | Code B |
| 29    | =     | =     | 29   | 65    | SOH  | a    | 65   | 101   | FNC 4        | Code A  | Code A |
| 30    | >     | >     | 30   | 66    | STX  | b    | 66   | 102   | FNC 1        | FNC 1   | FNC 1  |
| 31    | ?     | ?     | 31   | 67    | ETX  | c    | 67   | 103   | Start Code A |         |        |
| 32    | @     | @     | 32   | 68    | EOT  | d    | 68   | 104   | Start Code B |         |        |
| 33    | A     | A     | 33   | 69    | ENQ  | e    | 69   | 105   | Start Code C |         |        |
| 34    | B     | B     | 34   | 70    | ACK  | f    | 70   |       |              |         |        |
| 35    | C     | C     | 35   | 71    | BEL  | g    | 71   |       |              |         |        |

## Example

| Sample Code   | Result  |
|---|---|
| <pre> SIZE 4,1 GAP 0,0 DIRECTION 1 CLS TEXT 10,10, "2",0,1,1, "Human readable alignment" BARCODE 10,50, "128",100,1,0,2,2, "left" BARCODE 310,50, "128",100,2,0,2,2, "center" BARCODE 610,50, "128",100,3,0,2,2, "right" PRINT 1 </pre> | <p>Human readable alignment</p>  <p>left center right</p>                   |
| <pre> SIZE 4,1 GAP 0,0 DIRECTION 1 CLS TEXT 10,10, "2",0,1,1, "Code 128, switch code subset automatically." BARCODE 10,50, "128",100,1,0,2,2, "123456abcd123456" PRINT 1 </pre>   | <p>Code 128, switch code subset automatically.</p>  <p>123456abcd123456</p> |

|   |  |
|---|--|
| <p>SIZE 4,1<br/>GAP 0,0<br/>DIRECTION 1<br/>CLS<br/>TEXT 10,10, "2",0,1,1, "Code 128, switch code subset manually."<br/>BARCODE 10,50, "128M",100,1,0,2,2, "!104!096ABCD!101EFGH"<br/>PRINT 1</p> <p><b>Note:</b><br/><i>The above example of code 128M encoded with CODE B start character. The next character will be the code 128 function character FNC3 which is then followed by the ABCD characters and EFGH characters encoded as CODE A subset.</i></p>  | <p>Code 128, switch code subset manually.</p>  <p>ABCDEFGH</p>   |
| <p>SIZE 4,1<br/>GAP 0,0<br/>DIRECTION 1<br/>CLS<br/>TEXT 10,10, "2",0,1,1, "TELEPEN"<br/>BARCODE 10,50, "TELEPEN",100,1,0,2,6, "abcd1234ABCD"<br/>PRINT 1</p>   | <p>TELEPEN</p>  <p>abcd1234ABCD</p>  |
| <p>SIZE 4,4<br/>GAP 0,0<br/>DIRECTION 1<br/>CLS<br/>TEXT 400,26, "2",0,1,1,2, "TELEPEN Number"<br/>BARCODE 400,50, "TELEPENN",60,2,0,2,6,2, "1234567890"<br/>TEXT 400,136, "2",0,1,1,2, "Code 11"<br/>BARCODE 400,160, "11",60,2,0,2,6,2, "1234567890"<br/>TEXT 400,246, "2",0,1,1,2, "PLANET"<br/>BARCODE 400,270, "PLANET",60,2,0,2,2,2, "12345678901"<br/>TEXT 400,356, "2",0,1,1,2, "Deutsche Post Identcode."<br/>BARCODE 400,380, "DPI",60,2,0,2,6,2, "12345678901"<br/>TEXT 400,466, "2",0,1,1,2, "Deutsche Post Leitcode. "<br/>BARCODE 400,490, "DPL",60,2,0,2,6,2, "123456789012"<br/>TEXT 400,576, "2",0,1,1,2, "Code 49"<br/>BARCODE 400,600, "CODE49",60,2,0,2,2,2, "1234567890"<br/>PRINT 1</p> |  <p>TELEPEN Number</p>  <p>1234567890<br/>Code 11</p>  <p>1234567890<br/>PLANET</p>  <p>12345678901<br/>Deutsche Post Identcode.</p>  <p>123456789016<br/>Deutsche Post Leitcode.</p>  <p>01234567890128<br/>Code 49</p>  <p>1234567890</p> |



## ● TLC39

### Description

This command draws TLC39, TCIF Linked Bar Code 3 of 9, barcode.

### Syntax

**TLC39 x,y,rotation,[height],[narrow],[wide],[cellwidth],[cellheight,] "ECI number,Serial number & additional data"**

| <u>Parameter</u>                | <u>Description</u>  |
|---------------------------------|---|
| x                               | Specify the x-coordinate  |
| y                               | Specify the y-coordinate  |
| rotation                        | 0 : No rotation<br>90 : Rotate 90 degrees clockwise<br>180 : Rotate 180 degrees clockwise<br>270 : Rotate 270 degrees clockwise |
| height                          | Height of Code39 in dots (Default is 40)  |
| narrow                          | Width of narrow element of Code39 in dots (Default is 2)  |
| wide                            | Width of wide element of Code39 in dots (Default is 4)  |
| cellwidth                       | Width of cell of MicroPDF417 in dots (Default is 2)   |
| cellheight                      | Height of cell of MicroPDF417 in dots (Default is 4)  |
| ECI number                      | Must be 6 digits which is used to generate Code39   |
| Serial number & additional data | Alphanumeric is for Micro-PDF417  |

**Note:**

- *Comma (",) is necessary between ECI number and Serial number & additional data.*
- *This command has been supported since V6.89 EZ and later firmware.*

### Example

| <u>Sample Code</u>  |
|---|
| <pre> SIZE 4,1.2 GAP 0,0 DIRECTION 1 CLS TEXT 10,10, "3",0,1,1, "TLC39 code" TLC39 10,50,0, "123456,SN00000001,00601,01501" TLC39 310,50,0,80,3,6,3,4, "123456,SN00000001,00601,01501" PRINT 1 </pre> |
| <u>Result</u>   |
| <p style="text-align: center;">TLC39 code</p>   |

## ● BITMAP

### Description

This command draws bitmap images (as opposed to BMP graphic files).

### Syntax

**BITMAP** X,Y,width,height,mode,bitmap data...

| <u>Parameter</u> | <u>Description</u>   |
|------------------|--|
| X                | Specify the x-coordinate                                       |
| Y                | Specify the y-coordinate                                       |
| width            | Image width (in bytes)   |
| height           | Image height (in dots)   |
| mode             | Graphic modes listed below:<br>0: OVERWRITE<br>1: OR<br>2: XOR |
| bitmap data      | Bitmap data  |

### Example

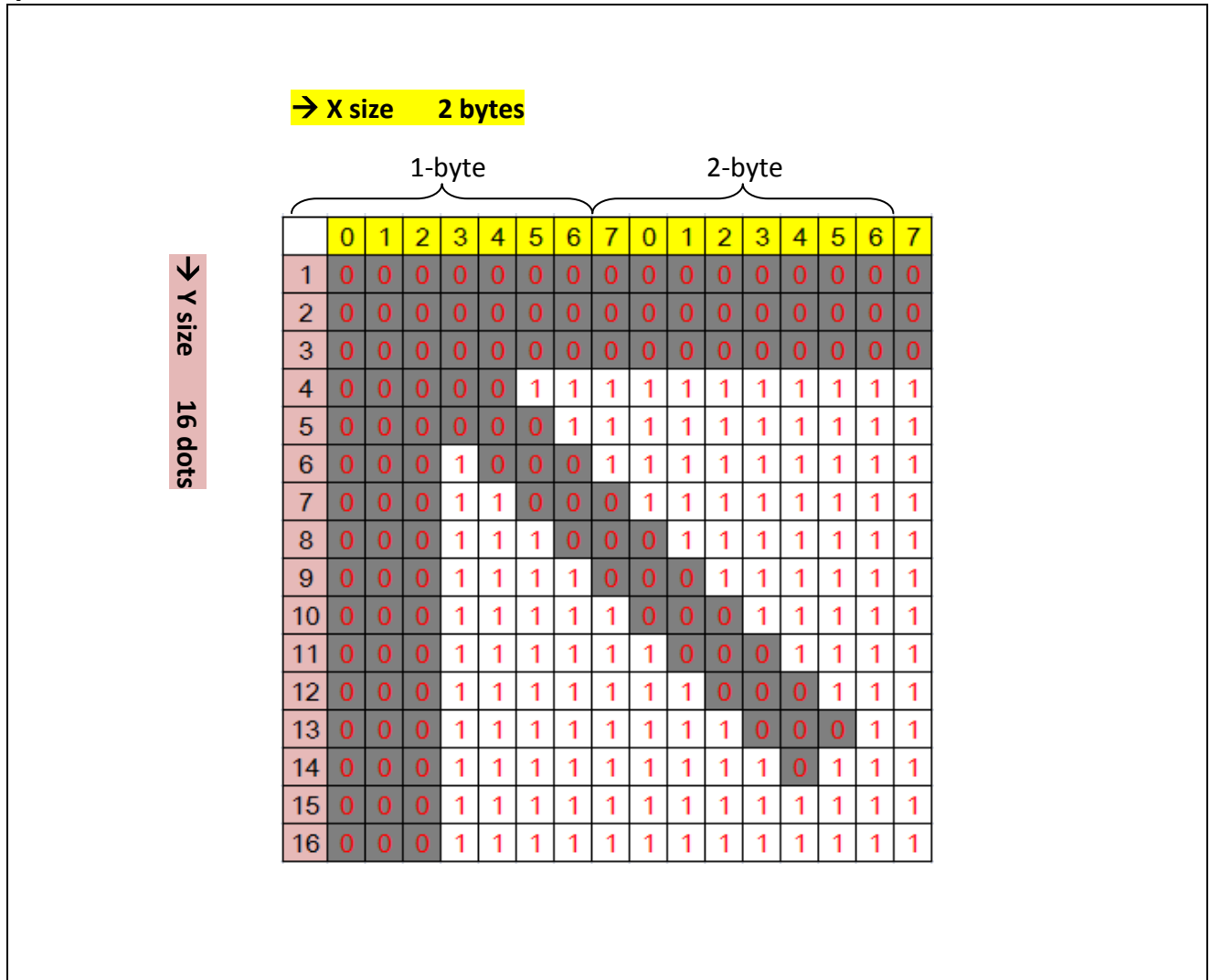

| Y- axis | X – axis |             |          |             |
|---------|----------|-------------|----------|-------------|
|         | 1-byte   |             | 2-byte   |             |
|         | Binary   | Hexadecimal | Binary   | Hexadecimal |
| 1       | 00000000 | 00          | 00000000 | 00          |
| 2       | 00000000 | 00          | 00000000 | 00          |
| 3       | 00000000 | 00          | 00000000 | 00          |
| 4       | 00000111 | 07          | 11111111 | FF          |
| 5       | 00000011 | 03          | 11111111 | FF          |
| 6       | 00010001 | 11          | 11111111 | FF          |
| 7       | 00011000 | 18          | 11111111 | FF          |
| 8       | 00011100 | 1C          | 01111111 | 7F          |
| 9       | 00011110 | 1E          | 00111111 | 3F          |
| 10      | 00011111 | 1F          | 00011111 | 1F          |
| 11      | 00011111 | 1F          | 10001111 | 8F          |
| 12      | 00011111 | 1F          | 11000111 | C7          |
| 13      | 00011111 | 1F          | 11100011 | E3          |
| 14      | 00011111 | 1F          | 11110111 | F7          |
| 15      | 00011111 | 1F          | 11111111 | FF          |
| 16      | 00011111 | 1F          | 11111111 | FF          |

| Sample Code (ASCII)    | Hexadecimal                   | Result |
|------------------------|-------------------------------|--------|
| SIZE 4,2               | 53 49 5A 45 20 34 2C 32 0D    | ↖      |
| GAP 0,0                | 0A 47 41 50 20 30 2C 30 0D    |        |
| CLS                    | 0A 43 4C 53 0D 0A 42 49 54    |        |
| BITMAP 200,200,2,16,0, | 4D 41 50 20 32 30 30 2C 32 30 |        |
| ▣ _____ ▣ ▣ ▣ ▣-?-     | 30 2C 32 2C 31 36 2C 30 2C 00 |        |
| ???? ▣                 | 00 00 00 00 00 07 FF 03 FF 11 |        |
| PRINT 1,1              | FF 18 FF 1C 7F 1E 3F 1F 1F 1F |        |
|                        | 8F 1F C7 1F E3 1F E7 1F FF 1F |        |
|                        | FF 0D 0A 50 52 49 4E 54 20 31 |        |
|                        | 2C 31 0D 0A                   |        |

## See Also

PUTBMP, PUTPCX

## ● BOX

### Description

This command draws rectangles on the label.

### Syntax

**BOX** x,y,x\_end,y\_end,line thickness[,radius]

| <u>Parameter</u> | <u>Description</u>  |
|------------------|---|
| x                | Specify x-coordinate of upper left corner (in dots)                         |
| y                | Specify y-coordinate of upper left corner (in dots)                         |
| x_end            | Specify x-coordinate of lower right corner (in dots)                        |
| y_end            | Specify y-coordinate of lower right corner (in dots)                        |
| line thickness   | Line thickness (in dots)  |
| radius           | Optional. Specify the round corner. Default is 0.<br><i>*Since V5.28 EZ</i> |

**Note:**

- **200 DPI : 1 mm = 8 dots**  
**300 DPI : 1 mm = 12 dots**
- **Recommended max. thickness of box is 12 mm at 4" width. Thickness of box larger than 12 mm may damage the power supply and affect the print quality. Max. print ratio is different for each printer model. Desktop and industrial printer print ratio is limited to 20% and 30% respectively.**

### Example

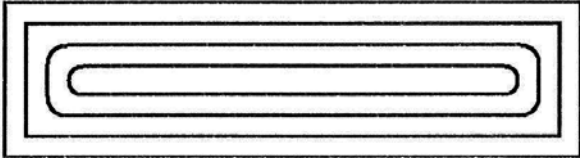
| <u>Sample code</u>  | <u>Result</u>  |
|---|--|
| <pre>SIZE 4,1.1 CLS BOX 60,60,610,210,4 BOX 80,80,590,190,4 BOX 100,100,570,170,4,20 BOX 120,120,550,150,4,20 PRINT 1</pre> |  |

### See Also

BAR

## ● CIRCLE

### Description

This command draws a circle on the label.

### Syntax

**CIRCLE X\_start,Y\_start,diameter,thickness**

| <u>Parameter</u> | <u>Description</u>                                  |
|------------------|---|
| X_start          | Specify x-coordinate of upper left corner (in dots) |
| Y_start          | Specify y-coordinate of upper left corner (in dots) |
| diameter         | Specify the diameter of the circle (in dots)        |
| thickness        | Thickness of the circle (in dots)                   |

### Example

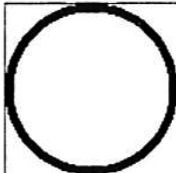
| <u>Sample code</u>  | <u>Result</u>   |
|---|---|
| <pre>SIZE 80 mm,30 mm GAP 0,0 DIRECTION 1 CLS BAR 250,20,100,1 BAR 250,20,1,100 CIRCLE 250,20,100,5 PRINT 1</pre> |  |

## ● ELLIPSE

### Description

This command draws an ellipse on the label.

### Syntax

**ELLIPSE x,y,width,height,thickness**

| <u>Parameter</u> | <u>Description</u>                                  |
|------------------|---|
| x                | Specify x-coordinate of upper left corner (in dots) |
| y                | Specify y-coordinate of upper left corner (in dots) |
| width            | Specify the width of the ellipse (in dots)          |
| height           | Specify the height of the ellipse (in dots)         |
| thickness        | Thickness of the ellipse (in dots)                  |

**Note:**  
*This command has been supported since V6.91 EZ and later firmware.*

### Example

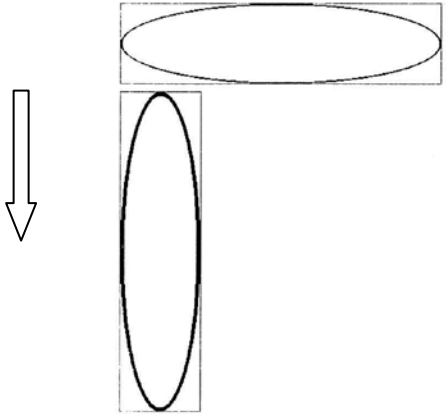
| <u>Sample code</u>  | <u>Result</u>  |
|---|--|
| <pre>SIZE 4,3 GAP 0,0 DIRECTION 1 CLS BOX 10,10,410,110,1 ELLIPSE 10,10,400,100,2 BOX 10,120,110,520,1 ELLIPSE 10,120,100,400,5 PRINT 1</pre> |  |

## ● CODABLOCK F mode

### Description

This command draws CODABLOCK F mode barcode.

### Syntax

**CODABLOCK x,y,rotation,[row height,]module width,] "content"**

| <u>Parameter</u> | <u>Description</u>  |
|------------------|---|
| x                | Specify the x-coordinate  |
| y                | Specify the y-coordinate  |
| rotation         | 0 : No rotation<br>90 : Rotate 90 degrees clockwise<br>180 : Rotate 180 degrees clockwise<br>270 : Rotate 270 degrees clockwise |
| row height       | The height of individual row equals to row height x module width (Default is 8)   |
| module width     | Width of narrow element of CODABLOCK in dots (Default is 2)   |
| content          | content of CODABLOCK bar code   |

**Note:**  
*This command has been supported since V6.89 EZ and later firmware.*

### Example

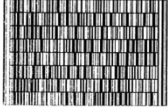
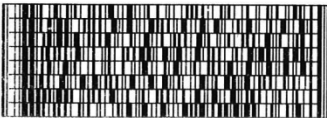
| Sample Code  |  |
|--|--|
| <pre> SIZE 4,1.5 GAP 0,0 DIRECTION 1 CLS TEXT 10,10, "3",0,1,1, "Codablock F" CODABLOCK 10,50,0, "We stand behind our products with one of the most comprehensive support programs in the Auto-ID industry." PRINT 1 CLS TEXT 10,10, "3",0,1,1, "Codablock F" CODABLOCK 10,50,0,16,1, "We stand behind our products with one of the most comprehensive support programs in the Auto-ID industry." PRINT 1 </pre> |  |
| Result   |  |
|   | <p>Codablock F</p> <br><p>Codablock F</p>  |

## ● DMATRIX

### Description

This command defines a DataMatrix 2D bar code. Currently, only ECC200 error correction is supported.



### Syntax

**DMATRIX x,y,width,height,[c#,x#,r#,a#,row,col,] "content"**

| Parameter   | Description   |           |           |       |           |         |         |         |        |         |         |         |        |         |         |         |         |         |         |         |         |         |         |           |         |         |         |           |         |         |         |           |    |         |         |           |    |    |    |     |    |    |    |    |    |     |    |    |     |    |    |     |    |    |    |    |    |     |    |    |     |    |    |     |    |    |    |    |    |     |    |    |    |    |    |     |    |    |    |    |    |     |    |    |    |    |    |     |    |    |    |    |    |     |    |    |    |    |    |     |    |    |    |    |    |     |    |    |    |
|---|---|-----------|-----------|-------|-----------|---------|---------|---------|--------|---------|---------|---------|--------|---------|---------|---------|---------|---------|---------|---------|---------|---------|---------|-----------|---------|---------|---------|-----------|---------|---------|---------|-----------|----|---------|---------|-----------|----|----|----|-----|----|----|----|----|----|-----|----|----|-----|----|----|-----|----|----|----|----|----|-----|----|----|-----|----|----|-----|----|----|----|----|----|-----|----|----|----|----|----|-----|----|----|----|----|----|-----|----|----|----|----|----|-----|----|----|----|----|----|-----|----|----|----|----|----|-----|----|----|----|----|----|-----|----|----|----|
| x   | Horizontal start position (in dots)   |           |           |       |           |         |         |         |        |         |         |         |        |         |         |         |         |         |         |         |         |         |         |           |         |         |         |           |         |         |         |           |    |         |         |           |    |    |    |     |    |    |    |    |    |     |    |    |     |    |    |     |    |    |    |    |    |     |    |    |     |    |    |     |    |    |    |    |    |     |    |    |    |    |    |     |    |    |    |    |    |     |    |    |    |    |    |     |    |    |    |    |    |     |    |    |    |    |    |     |    |    |    |    |    |     |    |    |    |
| y   | Vertical start position (in dots)   |           |           |       |           |         |         |         |        |         |         |         |        |         |         |         |         |         |         |         |         |         |         |           |         |         |         |           |         |         |         |           |    |         |         |           |    |    |    |     |    |    |    |    |    |     |    |    |     |    |    |     |    |    |    |    |    |     |    |    |     |    |    |     |    |    |    |    |    |     |    |    |    |    |    |     |    |    |    |    |    |     |    |    |    |    |    |     |    |    |    |    |    |     |    |    |    |    |    |     |    |    |    |    |    |     |    |    |    |
| width   | The expected width of barcode area (in dots)  |           |           |       |           |         |         |         |        |         |         |         |        |         |         |         |         |         |         |         |         |         |         |           |         |         |         |           |         |         |         |           |    |         |         |           |    |    |    |     |    |    |    |    |    |     |    |    |     |    |    |     |    |    |    |    |    |     |    |    |     |    |    |     |    |    |    |    |    |     |    |    |    |    |    |     |    |    |    |    |    |     |    |    |    |    |    |     |    |    |    |    |    |     |    |    |    |    |    |     |    |    |    |    |    |     |    |    |    |
| height  | The expected height of barcode area (in dots)   |           |           |       |           |         |         |         |        |         |         |         |        |         |         |         |         |         |         |         |         |         |         |           |         |         |         |           |         |         |         |           |    |         |         |           |    |    |    |     |    |    |    |    |    |     |    |    |     |    |    |     |    |    |    |    |    |     |    |    |     |    |    |     |    |    |    |    |    |     |    |    |    |    |    |     |    |    |    |    |    |     |    |    |    |    |    |     |    |    |    |    |    |     |    |    |    |    |    |     |    |    |    |    |    |     |    |    |    |
| c#  | Escape sequence control character (decimal digit)<br>Ex. C126 means ~<br>(1) ~X is shift character for control characters.  |           |           |       |           |         |         |         |        |         |         |         |        |         |         |         |         |         |         |         |         |         |         |           |         |         |         |           |         |         |         |           |    |         |         |           |    |    |    |     |    |    |    |    |    |     |    |    |     |    |    |     |    |    |    |    |    |     |    |    |     |    |    |     |    |    |    |    |    |     |    |    |    |    |    |     |    |    |    |    |    |     |    |    |    |    |    |     |    |    |    |    |    |     |    |    |    |    |    |     |    |    |    |    |    |     |    |    |    |
|   | <table border="1"> <thead> <tr> <th>~X</th> <th>Hex</th> <th>ASCII</th> <th>~X</th> <th>HEX</th> <th>ASCII</th> <th>~X</th> <th>HEX</th> <th>ASCII</th> <th>~X</th> <th>HEX</th> <th>ASCII</th> </tr> </thead> <tbody> <tr> <td>~@</td> <td>00</td> <td>NUL</td> <td>~H</td> <td>08</td> <td>BS</td> <td>~P</td> <td>10</td> <td>DLE</td> <td>~X</td> <td>18</td> <td>CAN</td> </tr> <tr> <td>~A</td> <td>01</td> <td>SOH</td> <td>~I</td> <td>09</td> <td>HT</td> <td>~Q</td> <td>11</td> <td>DC1</td> <td>~Y</td> <td>19</td> <td>EM</td> </tr> <tr> <td>~B</td> <td>02</td> <td>STX</td> <td>~J</td> <td>0A</td> <td>LF</td> <td>~R</td> <td>12</td> <td>DC2</td> <td>~Z</td> <td>1A</td> <td>SUB</td> </tr> <tr> <td>~C</td> <td>03</td> <td>ETX</td> <td>~K</td> <td>0B</td> <td>VT</td> <td>~S</td> <td>13</td> <td>DC3</td> <td>~[</td> <td>1B</td> <td>ESC</td> </tr> <tr> <td>~D</td> <td>04</td> <td>EOT</td> <td>~L</td> <td>0C</td> <td>FF</td> <td>~T</td> <td>14</td> <td>DC4</td> <td>~\</td> <td>1C</td> <td>FS</td> </tr> <tr> <td>~E</td> <td>05</td> <td>ENQ</td> <td>~M</td> <td>0D</td> <td>CR</td> <td>~U</td> <td>15</td> <td>NAK</td> <td>~]</td> <td>1D</td> <td>GS</td> </tr> <tr> <td>~F</td> <td>06</td> <td>ACK</td> <td>~N</td> <td>0E</td> <td>SO</td> <td>~V</td> <td>16</td> <td>SYN</td> <td>~^</td> <td>1E</td> <td>RS</td> </tr> <tr> <td>~G</td> <td>07</td> <td>BEL</td> <td>~O</td> <td>0F</td> <td>SI</td> <td>~W</td> <td>17</td> <td>ETB</td> <td>~_</td> <td>1F</td> <td>US</td> </tr> </tbody> </table> | ~X        | Hex       | ASCII | ~X        | HEX     | ASCII   | ~X      | HEX    | ASCII   | ~X      | HEX     | ASCII  | ~@      | 00      | NUL     | ~H      | 08      | BS      | ~P      | 10      | DLE     | ~X      | 18        | CAN     | ~A      | 01      | SOH       | ~I      | 09      | HT      | ~Q        | 11 | DC1     | ~Y      | 19        | EM | ~B | 02 | STX | ~J | 0A | LF | ~R | 12 | DC2 | ~Z | 1A | SUB | ~C | 03 | ETX | ~K | 0B | VT | ~S | 13 | DC3 | ~[ | 1B | ESC | ~D | 04 | EOT | ~L | 0C | FF | ~T | 14 | DC4 | ~\ | 1C | FS | ~E | 05 | ENQ | ~M | 0D | CR | ~U | 15 | NAK | ~] | 1D | GS | ~F | 06 | ACK | ~N | 0E | SO | ~V | 16 | SYN | ~^ | 1E | RS | ~G | 07 | BEL | ~O | 0F | SI | ~W | 17 | ETB | ~_ | 1F | US |
| ~X  | Hex   | ASCII     | ~X        | HEX   | ASCII     | ~X      | HEX     | ASCII   | ~X     | HEX     | ASCII   |         |        |         |         |         |         |         |         |         |         |         |         |           |         |         |         |           |         |         |         |           |    |         |         |           |    |    |    |     |    |    |    |    |    |     |    |    |     |    |    |     |    |    |    |    |    |     |    |    |     |    |    |     |    |    |    |    |    |     |    |    |    |    |    |     |    |    |    |    |    |     |    |    |    |    |    |     |    |    |    |    |    |     |    |    |    |    |    |     |    |    |    |    |    |     |    |    |    |
| ~@  | 00  | NUL       | ~H        | 08    | BS        | ~P      | 10      | DLE     | ~X     | 18      | CAN     |         |        |         |         |         |         |         |         |         |         |         |         |           |         |         |         |           |         |         |         |           |    |         |         |           |    |    |    |     |    |    |    |    |    |     |    |    |     |    |    |     |    |    |    |    |    |     |    |    |     |    |    |     |    |    |    |    |    |     |    |    |    |    |    |     |    |    |    |    |    |     |    |    |    |    |    |     |    |    |    |    |    |     |    |    |    |    |    |     |    |    |    |    |    |     |    |    |    |
| ~A  | 01  | SOH       | ~I        | 09    | HT        | ~Q      | 11      | DC1     | ~Y     | 19      | EM      |         |        |         |         |         |         |         |         |         |         |         |         |           |         |         |         |           |         |         |         |           |    |         |         |           |    |    |    |     |    |    |    |    |    |     |    |    |     |    |    |     |    |    |    |    |    |     |    |    |     |    |    |     |    |    |    |    |    |     |    |    |    |    |    |     |    |    |    |    |    |     |    |    |    |    |    |     |    |    |    |    |    |     |    |    |    |    |    |     |    |    |    |    |    |     |    |    |    |
| ~B  | 02  | STX       | ~J        | 0A    | LF        | ~R      | 12      | DC2     | ~Z     | 1A      | SUB     |         |        |         |         |         |         |         |         |         |         |         |         |           |         |         |         |           |         |         |         |           |    |         |         |           |    |    |    |     |    |    |    |    |    |     |    |    |     |    |    |     |    |    |    |    |    |     |    |    |     |    |    |     |    |    |    |    |    |     |    |    |    |    |    |     |    |    |    |    |    |     |    |    |    |    |    |     |    |    |    |    |    |     |    |    |    |    |    |     |    |    |    |    |    |     |    |    |    |
| ~C  | 03  | ETX       | ~K        | 0B    | VT        | ~S      | 13      | DC3     | ~[     | 1B      | ESC     |         |        |         |         |         |         |         |         |         |         |         |         |           |         |         |         |           |         |         |         |           |    |         |         |           |    |    |    |     |    |    |    |    |    |     |    |    |     |    |    |     |    |    |    |    |    |     |    |    |     |    |    |     |    |    |    |    |    |     |    |    |    |    |    |     |    |    |    |    |    |     |    |    |    |    |    |     |    |    |    |    |    |     |    |    |    |    |    |     |    |    |    |    |    |     |    |    |    |
| ~D  | 04  | EOT       | ~L        | 0C    | FF        | ~T      | 14      | DC4     | ~\     | 1C      | FS      |         |        |         |         |         |         |         |         |         |         |         |         |           |         |         |         |           |         |         |         |           |    |         |         |           |    |    |    |     |    |    |    |    |    |     |    |    |     |    |    |     |    |    |    |    |    |     |    |    |     |    |    |     |    |    |    |    |    |     |    |    |    |    |    |     |    |    |    |    |    |     |    |    |    |    |    |     |    |    |    |    |    |     |    |    |    |    |    |     |    |    |    |    |    |     |    |    |    |
| ~E  | 05  | ENQ       | ~M        | 0D    | CR        | ~U      | 15      | NAK     | ~]     | 1D      | GS      |         |        |         |         |         |         |         |         |         |         |         |         |           |         |         |         |           |         |         |         |           |    |         |         |           |    |    |    |     |    |    |    |    |    |     |    |    |     |    |    |     |    |    |    |    |    |     |    |    |     |    |    |     |    |    |    |    |    |     |    |    |    |    |    |     |    |    |    |    |    |     |    |    |    |    |    |     |    |    |    |    |    |     |    |    |    |    |    |     |    |    |    |    |    |     |    |    |    |
| ~F  | 06  | ACK       | ~N        | 0E    | SO        | ~V      | 16      | SYN     | ~^     | 1E      | RS      |         |        |         |         |         |         |         |         |         |         |         |         |           |         |         |         |           |         |         |         |           |    |         |         |           |    |    |    |     |    |    |    |    |    |     |    |    |     |    |    |     |    |    |    |    |    |     |    |    |     |    |    |     |    |    |    |    |    |     |    |    |    |    |    |     |    |    |    |    |    |     |    |    |    |    |    |     |    |    |    |    |    |     |    |    |    |    |    |     |    |    |    |    |    |     |    |    |    |
| ~G  | 07  | BEL       | ~O        | 0F    | SI        | ~W      | 17      | ETB     | ~_     | 1F      | US      |         |        |         |         |         |         |         |         |         |         |         |         |           |         |         |         |           |         |         |         |           |    |         |         |           |    |    |    |     |    |    |    |    |    |     |    |    |     |    |    |     |    |    |    |    |    |     |    |    |     |    |    |     |    |    |    |    |    |     |    |    |    |    |    |     |    |    |    |    |    |     |    |    |    |    |    |     |    |    |    |    |    |     |    |    |    |    |    |     |    |    |    |    |    |     |    |    |    |
|   | (2) ~1 means FNC1.  |           |           |       |           |         |         |         |        |         |         |         |        |         |         |         |         |         |         |         |         |         |         |           |         |         |         |           |         |         |         |           |    |         |         |           |    |    |    |     |    |    |    |    |    |     |    |    |     |    |    |     |    |    |    |    |    |     |    |    |     |    |    |     |    |    |    |    |    |     |    |    |    |    |    |     |    |    |    |    |    |     |    |    |    |    |    |     |    |    |    |    |    |     |    |    |    |    |    |     |    |    |    |    |    |     |    |    |    |
|   | (3) ~dNNN creates ASCII decimal value NNN for a codeword. Must be 3 digits. 000 ~ 255.  |           |           |       |           |         |         |         |        |         |         |         |        |         |         |         |         |         |         |         |         |         |         |           |         |         |         |           |         |         |         |           |    |         |         |           |    |    |    |     |    |    |    |    |    |     |    |    |     |    |    |     |    |    |    |    |    |     |    |    |     |    |    |     |    |    |    |    |    |     |    |    |    |    |    |     |    |    |    |    |    |     |    |    |    |    |    |     |    |    |    |    |    |     |    |    |    |    |    |     |    |    |    |    |    |     |    |    |    |
|   | (4) ~ in data is encoded by ~~.   |           |           |       |           |         |         |         |        |         |         |         |        |         |         |         |         |         |         |         |         |         |         |           |         |         |         |           |         |         |         |           |    |         |         |           |    |    |    |     |    |    |    |    |    |     |    |    |     |    |    |     |    |    |    |    |    |     |    |    |     |    |    |     |    |    |    |    |    |     |    |    |    |    |    |     |    |    |    |    |    |     |    |    |    |    |    |     |    |    |    |    |    |     |    |    |    |    |    |     |    |    |    |    |    |     |    |    |    |
| X#  | Module size (in dots)   |           |           |       |           |         |         |         |        |         |         |         |        |         |         |         |         |         |         |         |         |         |         |           |         |         |         |           |         |         |         |           |    |         |         |           |    |    |    |     |    |    |    |    |    |     |    |    |     |    |    |     |    |    |    |    |    |     |    |    |     |    |    |     |    |    |    |    |    |     |    |    |    |    |    |     |    |    |    |    |    |     |    |    |    |    |    |     |    |    |    |    |    |     |    |    |    |    |    |     |    |    |    |    |    |     |    |    |    |
| r#  | Rotation<br>0 : No rotation<br>90 : Rotate 90 degrees clockwise<br>180 : Rotate 180 degrees clockwise<br>270 : Rotate 270 degrees clockwise   |           |           |       |           |         |         |         |        |         |         |         |        |         |         |         |         |         |         |         |         |         |         |           |         |         |         |           |         |         |         |           |    |         |         |           |    |    |    |     |    |    |    |    |    |     |    |    |     |    |    |     |    |    |    |    |    |     |    |    |     |    |    |     |    |    |    |    |    |     |    |    |    |    |    |     |    |    |    |    |    |     |    |    |    |    |    |     |    |    |    |    |    |     |    |    |    |    |    |     |    |    |    |    |    |     |    |    |    |
| a#  | 0 : Square (default)<br>1 : Rectangle   |           |           |       |           |         |         |         |        |         |         |         |        |         |         |         |         |         |         |         |         |         |         |           |         |         |         |           |         |         |         |           |    |         |         |           |    |    |    |     |    |    |    |    |    |     |    |    |     |    |    |     |    |    |    |    |    |     |    |    |     |    |    |     |    |    |    |    |    |     |    |    |    |    |    |     |    |    |    |    |    |     |    |    |    |    |    |     |    |    |    |    |    |     |    |    |    |    |    |     |    |    |    |    |    |     |    |    |    |
| row   | Symbol size of row: 10 to 144   |           |           |       |           |         |         |         |        |         |         |         |        |         |         |         |         |         |         |         |         |         |         |           |         |         |         |           |         |         |         |           |    |         |         |           |    |    |    |     |    |    |    |    |    |     |    |    |     |    |    |     |    |    |    |    |    |     |    |    |     |    |    |     |    |    |    |    |    |     |    |    |    |    |    |     |    |    |    |    |    |     |    |    |    |    |    |     |    |    |    |    |    |     |    |    |    |    |    |     |    |    |    |    |    |     |    |    |    |
| col   | Symbol size of col: 10 to 144   |           |           |       |           |         |         |         |        |         |         |         |        |         |         |         |         |         |         |         |         |         |         |           |         |         |         |           |         |         |         |           |    |         |         |           |    |    |    |     |    |    |    |    |    |     |    |    |     |    |    |     |    |    |    |    |    |     |    |    |     |    |    |     |    |    |    |    |    |     |    |    |    |    |    |     |    |    |    |    |    |     |    |    |    |    |    |     |    |    |    |    |    |     |    |    |    |    |    |     |    |    |    |    |    |     |    |    |    |
| content   | Content of DataMatrix 2D bar code   |           |           |       |           |         |         |         |        |         |         |         |        |         |         |         |         |         |         |         |         |         |         |           |         |         |         |           |         |         |         |           |    |         |         |           |    |    |    |     |    |    |    |    |    |     |    |    |     |    |    |     |    |    |    |    |    |     |    |    |     |    |    |     |    |    |    |    |    |     |    |    |    |    |    |     |    |    |    |    |    |     |    |    |    |    |    |     |    |    |    |    |    |     |    |    |    |    |    |     |    |    |    |    |    |     |    |    |    |
| <b>Note:</b>  |   |           |           |       |           |         |         |         |        |         |         |         |        |         |         |         |         |         |         |         |         |         |         |           |         |         |         |           |         |         |         |           |    |         |         |           |    |    |    |     |    |    |    |    |    |     |    |    |     |    |    |     |    |    |    |    |    |     |    |    |     |    |    |     |    |    |    |    |    |     |    |    |    |    |    |     |    |    |    |    |    |     |    |    |    |    |    |     |    |    |    |    |    |     |    |    |    |    |    |     |    |    |    |    |    |     |    |    |    |
| - This command has been supported since V6.89 EZ and later firmware. The parameter "a#" has been supported since V8.01 EZ and later firmware.   |   |           |           |       |           |         |         |         |        |         |         |         |        |         |         |         |         |         |         |         |         |         |         |           |         |         |         |           |         |         |         |           |    |         |         |           |    |    |    |     |    |    |    |    |    |     |    |    |     |    |    |     |    |    |    |    |    |     |    |    |     |    |    |     |    |    |    |    |    |     |    |    |    |    |    |     |    |    |    |    |    |     |    |    |    |    |    |     |    |    |    |    |    |     |    |    |    |    |    |     |    |    |    |    |    |     |    |    |    |
| - For standard symbol sizes for DataMatrix 2D barcode, please refer to below list.  |   |           |           |       |           |         |         |         |        |         |         |         |        |         |         |         |         |         |         |         |         |         |         |           |         |         |         |           |         |         |         |           |    |         |         |           |    |    |    |     |    |    |    |    |    |     |    |    |     |    |    |     |    |    |    |    |    |     |    |    |     |    |    |     |    |    |    |    |    |     |    |    |    |    |    |     |    |    |    |    |    |     |    |    |    |    |    |     |    |    |    |    |    |     |    |    |    |    |    |     |    |    |    |    |    |     |    |    |    |
| <table border="1"> <thead> <tr> <th colspan="3">Square</th> <th>Rectangle</th> </tr> </thead> <tbody> <tr> <td>10 x 10</td> <td>26 x 26</td> <td>72 x 72</td> <td>8 x 18</td> </tr> <tr> <td>12 x 12</td> <td>32 x 32</td> <td>80 x 80</td> <td>8 x 32</td> </tr> <tr> <td>14 x 14</td> <td>36 x 36</td> <td>88 x 88</td> <td>12 x 26</td> </tr> <tr> <td>16 x 16</td> <td>40 x 40</td> <td>96 x 96</td> <td>12 x 36</td> </tr> <tr> <td>18 x 18</td> <td>44 x 44</td> <td>104 x 104</td> <td>16 x 36</td> </tr> <tr> <td>20 x 20</td> <td>48 x 48</td> <td>120 x 120</td> <td>16 x 48</td> </tr> <tr> <td>22 x 22</td> <td>52 x 52</td> <td>132 x 132</td> <td></td> </tr> <tr> <td>24 x 24</td> <td>64 x 64</td> <td>144 x 144</td> <td></td> </tr> </tbody> </table> |   | Square    |           |       | Rectangle | 10 x 10 | 26 x 26 | 72 x 72 | 8 x 18 | 12 x 12 | 32 x 32 | 80 x 80 | 8 x 32 | 14 x 14 | 36 x 36 | 88 x 88 | 12 x 26 | 16 x 16 | 40 x 40 | 96 x 96 | 12 x 36 | 18 x 18 | 44 x 44 | 104 x 104 | 16 x 36 | 20 x 20 | 48 x 48 | 120 x 120 | 16 x 48 | 22 x 22 | 52 x 52 | 132 x 132 |    | 24 x 24 | 64 x 64 | 144 x 144 |    |    |    |     |    |    |    |    |    |     |    |    |     |    |    |     |    |    |    |    |    |     |    |    |     |    |    |     |    |    |    |    |    |     |    |    |    |    |    |     |    |    |    |    |    |     |    |    |    |    |    |     |    |    |    |    |    |     |    |    |    |    |    |     |    |    |    |    |    |     |    |    |    |
| Square  |   |           | Rectangle |       |           |         |         |         |        |         |         |         |        |         |         |         |         |         |         |         |         |         |         |           |         |         |         |           |         |         |         |           |    |         |         |           |    |    |    |     |    |    |    |    |    |     |    |    |     |    |    |     |    |    |    |    |    |     |    |    |     |    |    |     |    |    |    |    |    |     |    |    |    |    |    |     |    |    |    |    |    |     |    |    |    |    |    |     |    |    |    |    |    |     |    |    |    |    |    |     |    |    |    |    |    |     |    |    |    |
| 10 x 10   | 26 x 26   | 72 x 72   | 8 x 18    |       |           |         |         |         |        |         |         |         |        |         |         |         |         |         |         |         |         |         |         |           |         |         |         |           |         |         |         |           |    |         |         |           |    |    |    |     |    |    |    |    |    |     |    |    |     |    |    |     |    |    |    |    |    |     |    |    |     |    |    |     |    |    |    |    |    |     |    |    |    |    |    |     |    |    |    |    |    |     |    |    |    |    |    |     |    |    |    |    |    |     |    |    |    |    |    |     |    |    |    |    |    |     |    |    |    |
| 12 x 12   | 32 x 32   | 80 x 80   | 8 x 32    |       |           |         |         |         |        |         |         |         |        |         |         |         |         |         |         |         |         |         |         |           |         |         |         |           |         |         |         |           |    |         |         |           |    |    |    |     |    |    |    |    |    |     |    |    |     |    |    |     |    |    |    |    |    |     |    |    |     |    |    |     |    |    |    |    |    |     |    |    |    |    |    |     |    |    |    |    |    |     |    |    |    |    |    |     |    |    |    |    |    |     |    |    |    |    |    |     |    |    |    |    |    |     |    |    |    |
| 14 x 14   | 36 x 36   | 88 x 88   | 12 x 26   |       |           |         |         |         |        |         |         |         |        |         |         |         |         |         |         |         |         |         |         |           |         |         |         |           |         |         |         |           |    |         |         |           |    |    |    |     |    |    |    |    |    |     |    |    |     |    |    |     |    |    |    |    |    |     |    |    |     |    |    |     |    |    |    |    |    |     |    |    |    |    |    |     |    |    |    |    |    |     |    |    |    |    |    |     |    |    |    |    |    |     |    |    |    |    |    |     |    |    |    |    |    |     |    |    |    |
| 16 x 16   | 40 x 40   | 96 x 96   | 12 x 36   |       |           |         |         |         |        |         |         |         |        |         |         |         |         |         |         |         |         |         |         |           |         |         |         |           |         |         |         |           |    |         |         |           |    |    |    |     |    |    |    |    |    |     |    |    |     |    |    |     |    |    |    |    |    |     |    |    |     |    |    |     |    |    |    |    |    |     |    |    |    |    |    |     |    |    |    |    |    |     |    |    |    |    |    |     |    |    |    |    |    |     |    |    |    |    |    |     |    |    |    |    |    |     |    |    |    |
| 18 x 18   | 44 x 44   | 104 x 104 | 16 x 36   |       |           |         |         |         |        |         |         |         |        |         |         |         |         |         |         |         |         |         |         |           |         |         |         |           |         |         |         |           |    |         |         |           |    |    |    |     |    |    |    |    |    |     |    |    |     |    |    |     |    |    |    |    |    |     |    |    |     |    |    |     |    |    |    |    |    |     |    |    |    |    |    |     |    |    |    |    |    |     |    |    |    |    |    |     |    |    |    |    |    |     |    |    |    |    |    |     |    |    |    |    |    |     |    |    |    |
| 20 x 20   | 48 x 48   | 120 x 120 | 16 x 48   |       |           |         |         |         |        |         |         |         |        |         |         |         |         |         |         |         |         |         |         |           |         |         |         |           |         |         |         |           |    |         |         |           |    |    |    |     |    |    |    |    |    |     |    |    |     |    |    |     |    |    |    |    |    |     |    |    |     |    |    |     |    |    |    |    |    |     |    |    |    |    |    |     |    |    |    |    |    |     |    |    |    |    |    |     |    |    |    |    |    |     |    |    |    |    |    |     |    |    |    |    |    |     |    |    |    |
| 22 x 22   | 52 x 52   | 132 x 132 |           |       |           |         |         |         |        |         |         |         |        |         |         |         |         |         |         |         |         |         |         |           |         |         |         |           |         |         |         |           |    |         |         |           |    |    |    |     |    |    |    |    |    |     |    |    |     |    |    |     |    |    |    |    |    |     |    |    |     |    |    |     |    |    |    |    |    |     |    |    |    |    |    |     |    |    |    |    |    |     |    |    |    |    |    |     |    |    |    |    |    |     |    |    |    |    |    |     |    |    |    |    |    |     |    |    |    |
| 24 x 24   | 64 x 64   | 144 x 144 |           |       |           |         |         |         |        |         |         |         |        |         |         |         |         |         |         |         |         |         |         |           |         |         |         |           |         |         |         |           |    |         |         |           |    |    |    |     |    |    |    |    |    |     |    |    |     |    |    |     |    |    |    |    |    |     |    |    |     |    |    |     |    |    |    |    |    |     |    |    |    |    |    |     |    |    |    |    |    |     |    |    |    |    |    |     |    |    |    |    |    |     |    |    |    |    |    |     |    |    |    |    |    |     |    |    |    |



## Example

| Sample code   | Result   |
|---|--|
| <p> <b>SIZE 4,3</b><br/> <b>GAP 0,0</b><br/> <b>DIRECTION 1</b><br/> <b>CLS</b><br/> <b>DMATRIX 10,110,400,400, "DMATRIX EXAMPLE 1"</b><br/> <b>DMATRIX 310,110,400,400,x6, "DMATRIX EXAMPLE 2"</b><br/> <b>DMATRIX 10,310,400,400,x8,18,18, "DMATRIX EXAMPLE 3"</b><br/> <b>PRINT 1,1</b> </p> |   |
| <p> <b>Sample code for FNC</b><br/><br/> <b>SIZE 4,1</b><br/> <b>GAP 0,0</b><br/> <b>CLS</b><br/> <b>DIRECTION 1</b><br/> <b>DMATRIX</b><br/> <b>100,50,100,100,c126,x6,18,18, "~1241sPn~110sLot~130sQty "</b><br/> <b>PRINT 1</b> </p>   |    |
| <p> <b>Sample code in rectangular shape</b><br/><br/> <b>SIZE 4,1</b><br/> <b>GAP 0,0</b><br/> <b>DIRECTION 1</b><br/> <b>CLS</b><br/> <b>DMATRIX 100,110,600,600,a1,"DMATRIX EXAMPLE 1"</b><br/> <b>PRINT 1,1</b> </p>   |  |

## ● ERASE

### Description

This command clears a specified region in the image buffer.

### Syntax

**ERASE** x,y,x\_width,y\_height

| <u>Parameter</u> | <u>Description</u>                               |
|------------------|--|
| x                | The x-coordinate of the starting point (in dots) |
| y                | The y-coordinate of the starting point (in dots) |
| x_width          | The region width in x-axis direction (in dots)   |
| y_height         | The region height in y-axis direction (in dots)  |

### Example

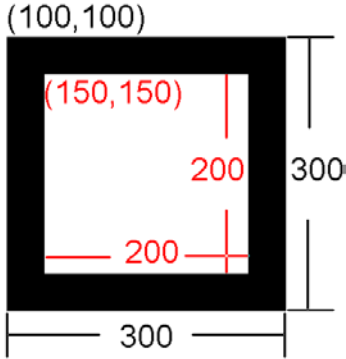
| <u>Sample code</u>  | <u>Result</u>   |
|---|---|
| <pre>SIZE 4,2.5 GAP 0,0 DIRECTION 1 CLS BAR 100,100,300,300 ERASE 150,150,200,200 PRINT 1,1</pre> |  |

### See Also

CLS

## ● MAXICODE

### Description

This command defines a 2D Maxicode.

### Syntax

|   |  |
|---|--|
| <b>MAXICODE x,y,mode,[class,country,post,Lm,] "content"</b>   |  |
| <b>MAXICODE x,y,mode,class,country,postal code, "content"</b> | For mode 2 or 3,<br>If country is 840, the postal code is in 99999,9999 format.<br>For other countries, the code is up to 6 alphanumeric characters. |
| <b>MAXICODE x,y,mode,[Lm,] "content"</b>                      | For mode 4,5,6,<br>AIM special format is supported, see page 23 in the spec.<br><b>Mode 6 is not supported in TSPL2 printer firmware.</b>            |

| <b>Parameter</b> | <b>Description</b>   |
|------------------|--|
| x                | X-coordinate of the starting point (in dot)  |
| y                | Y-coordinate of the starting point (in dot)  |
| mode             | 2,3,4,5  |
| class            | Class of service, 3-digit number (for mode 2,3)  |
| country          | Country code, 3-digit number (for mode 2,3)  |
| post             | Post code (for mode 2,3)<br>Mode 2(USA): 5-digit + 4-digit number<br>Mode 3(Canada): 6 alphanumeric post code included by double quotes. |
| Lm               | Expression length (double quote is ignored) , $1 \leq m \leq 138$ , (this parameter is just for mode 4 and 5)                            |
| content          | Content of 2D Maxicode   |
|                  | <b>Note:</b><br><b>If parameter Lm is used, double quotes (") are unnecessary.</b>   |

### Example

|   |
|---|
| <p><b>Sample code</b></p> <pre> SIZE 4,2 GAP 0,0 DIRECTION 1 CLS  REM *****Mode 2 For USA***** MAXICODE 110,100,2,300,840,06810,7317, "DEMO 2 FOR USA MAXICODE" TEXT 100,50, "3",0,1,1, "Mode 2 For USA" PRINT 1,1 </pre> |
|---|

REM \*\*\*\*\*Mode 3 For Canada\*\*\*\*\*

CLS

MAXICODE 110,100,3,300,863, "107317", "DEMO 3 FOR CANADA MAXICODE"

TEXT 100,50, "3",0,1,1, "Mode 3 For CANADA"

PRINT 1,1

REM \*\*\*\*\*MODE4\*\*\*\*\*

CLS

MAXICODE 110,100,4, "DEMO 4 FOR MAXICODE"

MAXICODE 600,100,4,L19,DEMO 4 FOR MAXICODE

TEXT 100,50, "3",0,1,1, "Mode 4 FOR MAXICODE"

PRINT 1,1

REM \*\*\*\*\*MODE 5\*\*\*\*\*

CLS

MAXICODE 110,100,5, "DEMO 5 FOR MAXICODE"

MAXICODE 600,100,5,L19,DEMO 5 FOR MAXICODE

TEXT 100,50, "3",0,1,1, "DEMO 5 FOR MAXICODE"

PRINT 1

## Result

DEMO 5 FOR MAXICODE



Mode 4 FOR MAXICODE



Mode 3 For CANADA



Mode 2 For USA

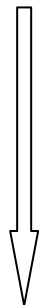

## ● PDF417

### Description

This command defines a PDF417 2D bar code.

### Syntax

**PDF417 x,y,width,height,rotate,[option], "content"**

| <u>Parameter</u> | <u>Description</u>  |   |   |   |                                     |   |   |        |  |   |                                  |   |                                 |   |                        |   |                           |   |  |    |   |
|------------------|---|---|---|---|-------------------------------------|---|---|--------|--|---|----------------------------------|---|---------------------------------|---|------------------------|---|---------------------------|---|--|----|---|
| x                | X-coordinate of starting point (in dot)   |   |   |   |                                     |   |   |        |  |   |                                  |   |                                 |   |                        |   |                           |   |  |    |   |
| y                | Y-coordinate of starting point (in dot)   |   |   |   |                                     |   |   |        |  |   |                                  |   |                                 |   |                        |   |                           |   |  |    |   |
| width            | Expected width (in dots)  |   |   |   |                                     |   |   |        |  |   |                                  |   |                                 |   |                        |   |                           |   |  |    |   |
| height           | Expected height (in dots)   |   |   |   |                                     |   |   |        |  |   |                                  |   |                                 |   |                        |   |                           |   |  |    |   |
| rotate           | Rotation counterclockwise<br>0 : No rotation<br>90 : Rotate 90 degrees<br>180 : Rotate 180 degrees<br>270 : Rotate 270 degrees  |   |   |   |                                     |   |   |        |  |   |                                  |   |                                 |   |                        |   |                           |   |  |    |   |
| option           | <table border="1"> <tr> <td>P</td> <td>Data compression method<br/>0: Auto encoding<br/>1: Binary mode</td> </tr> <tr> <td>E</td> <td>Error correction level (Range: 0~8)</td> </tr> <tr> <td>M</td> <td>Center pattern in barcode area<br/>0: The pattern will print upper left justified the area<br/>1: The pattern is printed middle of area</td> </tr> <tr> <td>Ux,y,c</td> <td>Human readable<br/>x: Human readable characters in the specified x-coordinate<br/>y: Human readable characters in the specified y-coordinate<br/>c: Maximum characters of human readable character per line</td> </tr> <tr> <td>W</td> <td>Module width in dot (Range: 2~9)</td> </tr> <tr> <td>H</td> <td>Bar height in dot (Range: 4~99)</td> </tr> <tr> <td>R</td> <td>Maximum number of rows</td> </tr> <tr> <td>C</td> <td>Maximum number of columns</td> </tr> <tr> <td>T</td> <td>Truncation<br/>0: Not truncated<br/>1: Truncated</td> </tr> <tr> <td>Lm</td> <td>Expression length, <math>1 \leq m \leq 2048</math> (without " for content)</td> </tr> </table> | P | Data compression method<br>0: Auto encoding<br>1: Binary mode | E | Error correction level (Range: 0~8) | M | Center pattern in barcode area<br>0: The pattern will print upper left justified the area<br>1: The pattern is printed middle of area | Ux,y,c | Human readable<br>x: Human readable characters in the specified x-coordinate<br>y: Human readable characters in the specified y-coordinate<br>c: Maximum characters of human readable character per line | W | Module width in dot (Range: 2~9) | H | Bar height in dot (Range: 4~99) | R | Maximum number of rows | C | Maximum number of columns | T | Truncation<br>0: Not truncated<br>1: Truncated | Lm | Expression length, $1 \leq m \leq 2048$ (without " for content) |
| P                | Data compression method<br>0: Auto encoding<br>1: Binary mode   |   |   |   |                                     |   |   |        |  |   |                                  |   |                                 |   |                        |   |                           |   |  |    |   |
| E                | Error correction level (Range: 0~8)   |   |   |   |                                     |   |   |        |  |   |                                  |   |                                 |   |                        |   |                           |   |  |    |   |
| M                | Center pattern in barcode area<br>0: The pattern will print upper left justified the area<br>1: The pattern is printed middle of area   |   |   |   |                                     |   |   |        |  |   |                                  |   |                                 |   |                        |   |                           |   |  |    |   |
| Ux,y,c           | Human readable<br>x: Human readable characters in the specified x-coordinate<br>y: Human readable characters in the specified y-coordinate<br>c: Maximum characters of human readable character per line  |   |   |   |                                     |   |   |        |  |   |                                  |   |                                 |   |                        |   |                           |   |  |    |   |
| W                | Module width in dot (Range: 2~9)  |   |   |   |                                     |   |   |        |  |   |                                  |   |                                 |   |                        |   |                           |   |  |    |   |
| H                | Bar height in dot (Range: 4~99)   |   |   |   |                                     |   |   |        |  |   |                                  |   |                                 |   |                        |   |                           |   |  |    |   |
| R                | Maximum number of rows  |   |   |   |                                     |   |   |        |  |   |                                  |   |                                 |   |                        |   |                           |   |  |    |   |
| C                | Maximum number of columns   |   |   |   |                                     |   |   |        |  |   |                                  |   |                                 |   |                        |   |                           |   |  |    |   |
| T                | Truncation<br>0: Not truncated<br>1: Truncated  |   |   |   |                                     |   |   |        |  |   |                                  |   |                                 |   |                        |   |                           |   |  |    |   |
| Lm               | Expression length, $1 \leq m \leq 2048$ (without " for content)   |   |   |   |                                     |   |   |        |  |   |                                  |   |                                 |   |                        |   |                           |   |  |    |   |
| content          | Content of PDF417 2D bar code<br><b>Note:</b><br><b><i>If parameter Lm is used, double quotes (") are unnecessary for content.</i></b>  |   |   |   |                                     |   |   |        |  |   |                                  |   |                                 |   |                        |   |                           |   |  |    |   |

## Example

| Sample code   | Result |
|---|--------|
| <pre> SIZE 4,1 GAP 0,0 DIRECTION 1  REM *****WITHOUT OPTIONS***** CLS PDF417 50,50,400,200,0, "Without Options" PRINT 1,1           </pre>  |        |
| <pre> SIZE 4,1.5 GAP 0,0 DIRECTION 1  REM *****OPTION:E3***** CLS PDF417 50,50,400,200,0,E3, "Error correction level:3" PRINT 1,1  REM *****OPTION:E4***** CLS PDF417 50,50,400,200,0,E4, "Error correction level:4" PRINT 1,1           </pre>   | <br>   |
| <pre> SIZE 4,1.5 GAP 0,0 DIRECTION 1  REM *****OPTION:E4 W4***** CLS PDF417 50,50,600,600,0,E4,W4, "Error correction level:4 module width 4 dots" PRINT 1,1  REM *****OPTION:E4 W4 H4***** CLS PDF417 50,50,600,600,0,E4,W4,H4, "Error correction level:4 module width 4 dots bar height 4 dots" PRINT 1,1           </pre> | <br>   |
| <pre> SIZE 4,1.5 GAP 0,0 DIRECTION 1  REM *****OPTION:E4 W4 H4 R40 C4 T1***** CLS PDF417 50,50,800,800,0,E4,W4,H4,R40,C4,T1, "Error correction level:4 Module Width 4 dots Bar Height 4 dots Maximum Number of Rows:5 Rows Maximum number of columns:90 Cols Truncation:1" PRINT 1,1           </pre>                       |        |

SIZE 4,2.5  
GAP 0,0  
DIRECTION 1

REM \*\*\*\*\*OPTION:P1 E4 M1  
U50,300,50,W4,H4,R60,C4,T0,L297\*\*\*\*\*  
CLS  
PDF417  
50,50,900,600,0,P1,E4,M1,U50,300,50,W4,H4,R60,C4,  
T0,L297,Data compression method: P1  
Error correction level: E4  
Center pattern in barcode area: M1  
Human Readable: Yes: U50,300,50  
Module Width 4 dots: W4  
Bar Height 4 dots: H4  
Maximum Number of Rows: 60 Rows: R60  
Maximum number of columns: 4 Cols: C4  
Truncation:1: T0  
Expression length:297: L297  
PRINT 1,1



Data compression method: P1 Error correction level: E4 Center pattern in barcode area: M1 Human Readable: Yes: U50,300,50 Module Width 4 dots: W4 Bar Height 4 dots: H4 Maximum Number of Rows: 60 Rows: R60 Maximum number of columns: 4 Cols: C4 Truncation:1: T0 Expression length:297: L297

## ● AZTEC

### Description

This command defines a AZTEC 2D bar code.

### Syntax

|   |               |
|---|---------------|
| <b>AZTEC x,y,rotate,[size,]ecp,[flg,]menu,[multi,]rev,] "content"</b> | Since V6.60EZ |
| <b>AZTEC x,y,rotate,size,ecp,flg,menu,multi,rev,bytes,content</b>     | Since V6.91EZ |

| <u>Parameter</u> | <u>Description</u>   |
|------------------|--|
| x                | Horizontal start position (in dots)  |
| y                | Vertical start position (in dots)  |
| rotate           | Rotation<br>0 : No rotation<br>90 : Rotate 90 degrees<br>180 : Rotate 180 degrees<br>270 : Rotate 270 degrees  |
| size             | Element module size (1 to 20), default is 6  |
| ecp              | Error control (& symbol size/type) parameter<br>0 : default error correction level<br>1 to 99 : minimum error correction percentage<br>101 to 104 : 1 to 4-layer Compact symbol<br>201 to 232 : 1 to 32-layer Full-Range symbol<br>300 : a simple Aztec "Rune" |
| flg              | 0 : input message is straight bytes<br>1 : input uses "<Esc>n" for FLG(n), "<Esc><Esc>" for "<Esc>"  |
| menu             | Menu symbol (0 : no, 1 : yes), default is 0  |
| multi            | Number of symbols (1 to 26), default is 6  |
| rev              | Output to be reversed (0 : no, 1 : yes), default is 0  |
| bytes            | Length of content  |
| content          | Content of AZTEC 2D bar code   |
|                  | <b>Note:</b><br><i>If parameter bytes is used, double quotes (") are unnecessary.</i>  |

### Example

| <u>Sample Code</u>  | <u>Result</u> |
|---|---------------|
| <pre> SIZE 4,2 GAP 0,0 CLS AZTEC 10,10,0,"ABCDEFGHJKLMNOPQRSTUVWXYZ0123456789" AZTEC 210,10,0,4,"ABCDEFGHJKLMNOPQRSTUVWXYZ0123456789" AZTEC 410,10,0,4,1,"ABCDEFGHJKLMNOPQRSTUVWXYZ0123456789" AZTEC 610,10,0,4,1,0,"ABCDEFGHJKLMNOPQRSTUVWXYZ0123456789" AZTEC 10,310,0,4,1,0,0,"ABCDEFGHJKLMNOPQRSTUVWXYZ0123456789" AZTEC 210,310,0,4,1,0,0,1,"ABCDEFGHJKLMNOPQRSTUVWXYZ0123456789" AZTEC 410,310,0,4,1,0,0,1,1,"ABCDEFGHJKLMNOPQRSTUVWXYZ0123456789" AZTEC 610,310,0,4,1,0,0,1,1,10,1234567890 PRINT 1           </pre> |               |



## ● MPDF417

### Description

This command defines a Micro PDF 417 bar code.

### Syntax

**MPDF417** x,y,rotate,[Wn,][Hn,][Cn,] "content"

| <u>Parameter</u>  | <u>Description</u>  |
|---|---|
| x   | Horizontal start position (in dots)   |
| y   | Vertical start position (in dots)   |
| rotate  | Rotation<br>0 : No rotation<br>90 : Rotate 90 degrees<br>180 : Rotate 180 degrees<br>270 : Rotate 270 degrees   |
| Wn  | Optional. Module width in dot. Default is 1.  |
| Hn  | Optional. Module height in dot. Default is 10.  |
| Cn  | Optional. Number of columns. Once the parameter is set, the printer will calculate the proper rows for the barcode base on the content automatically.<br>0: Auto mode.<br>1: Column is 1 and the calculated suitable rows will be 11, 14, 17, 20, 24, and 28.<br>2: Column is 2 and the calculated suitable rows will be 8, 11, 14, 17, 20, 23 and 26.<br>3: Column is 3 and the calculated suitable rows will be 6, 8, 10, 12, 15, 20, 26, 32, 38 and 44.<br>4: Column is 4 and the calculated suitable rows will be 4, 6, 8, 10, 12, 15, 20, 26, 32, 38 and 44. |
| Content   | Content of Micro PDF 417 bar code   |
| <b>Note:</b><br><i>This command has been supported since V6.61 EZ and later firmware.</i> |   |

### Example

| <u>Sample Code</u>   |
|--|
| <pre> SIZE 4,1 GAP 0,0 CLS MPDF417 10,10,0, "ABCDEFGHJKLMNOPQRSTUVWXYZ0123456789 " MPDF417 110,10,0,W2, "ABCDEFGHJKLMNOPQRSTUVWXYZ0123456789 " MPDF417 210,10,0,W2,H3, "ABCDEFGHJKLMNOPQRSTUVWXYZ0123456789 " MPDF417 310,10,0,W2,H3,C3, "ABCDEFGHJKLMNOPQRSTUVWXYZ0123456789 " PRINT 1 </pre> |
| <u>Result</u>  |
|    |

## ● PUTBMP

### Description

This command prints BMP format images. The grayscale printing is for direct thermal mode only. Support 1-bit (monochrome) and 8-bit (256-color) BMP graphic only.

### Syntax

**PUTBMP x,y,"filename" [, bpp][, contrast]**

| Parameter | Description  |
|-----------|--|
| x         | The x-coordinate of the BMP format image   |
| y         | The y-coordinate of the BMP format image   |
| filename  | The downloaded BMP filename (Support ZPL *.GRF)  |
| bpp       | Optional. Bits per pixel of grayscale graphic. Default is 1. <b>*Since V6.91EZ.</b><br>1: 1-bit (monochrome) graphic<br>8: 8-bit (256-color) graphic |
| contrast  | Optional. Contrast of grayscale graphic. Default is 80. Suggested range is from 60 to 100. <b>*Since V6.91EZ.</b>                                    |

Note: TDP-643 Plus, TTP-243, TTP-342, TTP-244ME, TTP-342M and TTP-248M series are not supported this PUTBMP command.

### Example

**Downloading BMP file into printer by DiagTool**

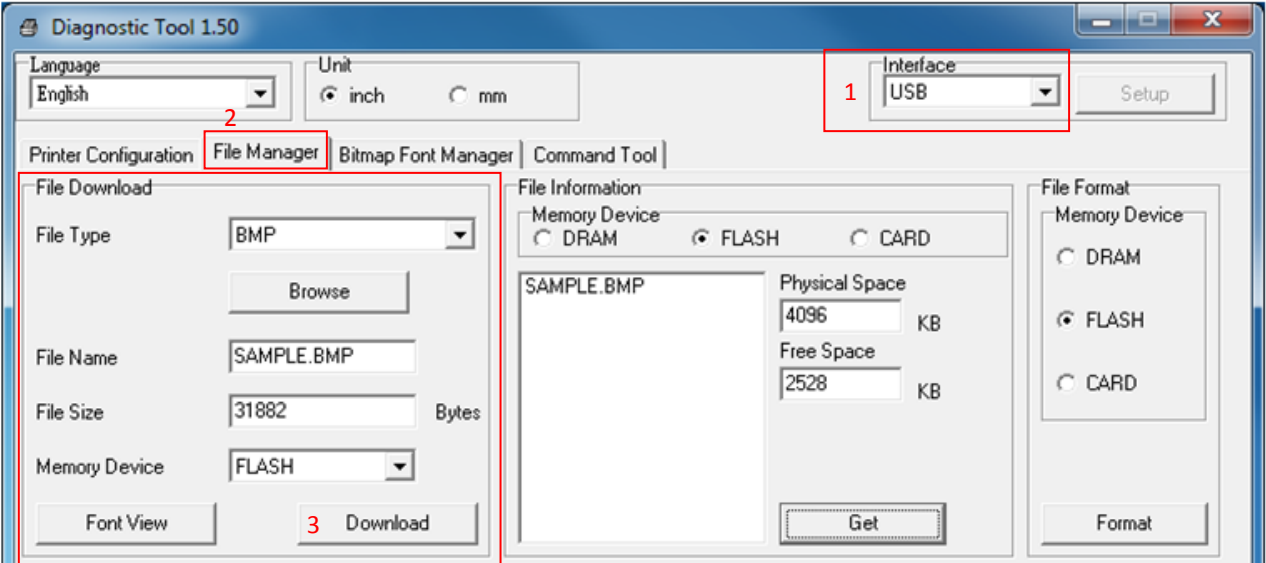

**Sample Code**  
**SPEED 2**  
**DENSITY 3**

```
SIZE 4,1.5
GAP 0,0
DIRECTION 1
CLS
PUTBMP 10,10,"SAMPLE.BMP"
BLOCK 10,180,240,100,"2",0,1,1,"bpp and contrast are omitted."
PUTBMP 300,10, "SAMPLE.BMP",1,80
BLOCK 300,180,240,100,"2",0,1,1, "bpp = 1
contrast = 80"
PUTBMP 590,10, "SAMPLE.BMP",8,80
BLOCK 590,180,240,100,"2",0,1,1,"bpp = 8
contrast = 80"
PRINT 1
```

### Result

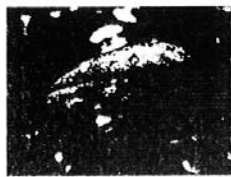

bpp and contrast  
are omitted.

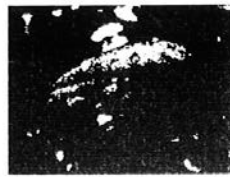

bpp = 1  
contrast = 80



bpp = 8  
contrast = 80

### Sample Code

```
SIZE 2,2
GAP 0,0
CLS
PUTBMP 10,10, "SAMPLE.GRF"
PRINT 1
```

### See Also

DOWNLOAD, BITMAP, PUTPCX

## ● PUTPCX

### Description

This command prints PCX format images. TSPL language supports 2-color PCX format graphics. TSPL2 language supports 256-color PCX format graphics.

Note: Please refer to [printer model list](#) for checking TSPL or TSPL2.

### Syntax

**PUTPCX x,y, "filename"**

| <u>Parameter</u> | <u>Description</u>                                     |
|------------------|--|
| x                | The X-coordinate of the PCX format image               |
| y                | The Y-coordinate of the PCX format image               |
| filename         | The downloaded PCX file name ( <b>Case sensitive</b> ) |

### Example

**Downloading PCX file into printer by DiagTool**

Diagnostic Tool 1.50

Language: English Unit:  inch  mm

Interface: USB

Printer Configuration | **File Manager** | Bitmap Font Manager | Command Tool

**File Download**

File Type: PCX

Browse

File Name: SAMPLE.PCX

File Size: 31882 Bytes

Memory Device: FLASH

Font View Download

**File Information**

Memory Device:  DRAM  FLASH  CARD

SAMPLE.PCX

Physical Space: 4096 KB

Free Space: 2528 KB

Get

**File Format**

Memory Device:  DRAM  FLASH  CARD

Format



### Sample Code

```
SPEED 2
DENSITY 3
SIZE 4,1.5
GAP 0,0
DIRECTION 1
CLS
PUTBMP 10,10, "SAMPLE.PCX"
PRINT 1
```

**Result**

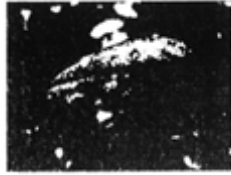

**See Also**

DOWNLOAD, BITMAP, PUTPCX

## ● QRCODE

### Description

This command prints QR code.

### Syntax

**QRCODE x,y,ECC Level,cell width,mode,rotation,[justification,]model,]mask,]area] "content"**

| <u>Parameter</u>  | <u>Description</u>  |                        |                        |                        |              |                  |                  |                   |                |                  |                 |                |                  |            |                |                  |
|-------------------|---|------------------------|------------------------|------------------------|--------------|------------------|------------------|-------------------|----------------|------------------|-----------------|----------------|------------------|------------|----------------|------------------|
| x                 | The upper left corner x-coordinate of the QR code   |                        |                        |                        |              |                  |                  |                   |                |                  |                 |                |                  |            |                |                  |
| y                 | The upper left corner y-coordinate of the QR code   |                        |                        |                        |              |                  |                  |                   |                |                  |                 |                |                  |            |                |                  |
| ECC level         | Error correction recovery level<br>L : 7%<br>M : 15%<br>Q : 25%<br>H : 30%  |                        |                        |                        |              |                  |                  |                   |                |                  |                 |                |                  |            |                |                  |
| cell width        | 1~10  |                        |                        |                        |              |                  |                  |                   |                |                  |                 |                |                  |            |                |                  |
| mode              | Auto / manual encode<br>A : Auto<br>M : Manual  |                        |                        |                        |              |                  |                  |                   |                |                  |                 |                |                  |            |                |                  |
| rotation          | 0 : 0 degree<br>90 : 90 degree<br>180 : 180 degree<br>270 : 270 degree  |                        |                        |                        |              |                  |                  |                   |                |                  |                 |                |                  |            |                |                  |
| [justification]   | Barcode justification (J1 to J9 valid; refer to "Sample code" example below); since version A1.97 firmware.   |                        |                        |                        |              |                  |                  |                   |                |                  |                 |                |                  |            |                |                  |
| [model]           | M1: (default), original version<br>M2: enhanced version (Almost smart phone is supported by this version.)  |                        |                        |                        |              |                  |                  |                   |                |                  |                 |                |                  |            |                |                  |
| [mask]            | S0~S8, default is S7  |                        |                        |                        |              |                  |                  |                   |                |                  |                 |                |                  |            |                |                  |
| [area]            | Maximum size of barcode area (Xdots; ex: X100); since version A1.97 firmware.   |                        |                        |                        |              |                  |                  |                   |                |                  |                 |                |                  |            |                |                  |
| content           | The encodable character set is described as below,<br><b>Encodable character set:</b><br>1) Numeric data: (digits 0~9)<br>2) Alphanumeric data<br>Digits 0-9<br>Upper case letters A-Z<br>Nine other characters: space, \$ % * + - . / : )<br>3) 8-bit byte data<br>JIS 8-bit character set (Latin and Kana) in accordance with JIS X 0201<br>4) Kanji characters<br>Shift JIS values 8140 <sub>HEX</sub> -9FFC <sub>HEX</sub> and E040 <sub>HEX</sub> -EAA4 <sub>HEX</sub> . These are values shifted from those of JIS X 0208. Refer to JIS X 0208 Annex 1 Shift Coded Representation for detail.<br><b>Data characters per symbol (for maximum symbol size):</b><br><table border="1" style="width: 100%; border-collapse: collapse;"> <thead> <tr> <th></th> <th>Model 1 (Version 14-L)</th> <th>Model 2 (Version 40-L)</th> </tr> </thead> <tbody> <tr> <td>Numeric data</td> <td>1,167 characters</td> <td>7,089 characters</td> </tr> <tr> <td>Alphanumeric data</td> <td>707 characters</td> <td>4,296 characters</td> </tr> <tr> <td>8-bit byte data</td> <td>486 characters</td> <td>2,953 characters</td> </tr> <tr> <td>Kanji data</td> <td>299 characters</td> <td>1,817 characters</td> </tr> </tbody> </table> |                        | Model 1 (Version 14-L) | Model 2 (Version 40-L) | Numeric data | 1,167 characters | 7,089 characters | Alphanumeric data | 707 characters | 4,296 characters | 8-bit byte data | 486 characters | 2,953 characters | Kanji data | 299 characters | 1,817 characters |
|                   | Model 1 (Version 14-L)  | Model 2 (Version 40-L) |                        |                        |              |                  |                  |                   |                |                  |                 |                |                  |            |                |                  |
| Numeric data      | 1,167 characters  | 7,089 characters       |                        |                        |              |                  |                  |                   |                |                  |                 |                |                  |            |                |                  |
| Alphanumeric data | 707 characters  | 4,296 characters       |                        |                        |              |                  |                  |                   |                |                  |                 |                |                  |            |                |                  |
| 8-bit byte data   | 486 characters  | 2,953 characters       |                        |                        |              |                  |                  |                   |                |                  |                 |                |                  |            |                |                  |
| Kanji data        | 299 characters  | 1,817 characters       |                        |                        |              |                  |                  |                   |                |                  |                 |                |                  |            |                |                  |
|                   | * If "A" is the first character in the data string, then the following data after "A" is alphanumeric data.   |                        |                        |                        |              |                  |                  |                   |                |                  |                 |                |                  |            |                |                  |

- \*If "N" is the first character in the data string, then the following data after "N" is numeric data.
- \*If "B" is the first character in the data string, then the following 4 digits after "B" is used to specify numbers of data. After the 4 digits is the number of bytes of binary data to be encoded.
- \*If "K" is the first character in the data string, then the following data after "K" is Kanji data.
- \*If "!" is in the data string and follows by "N", "A", "B", "K" then it will be switched to specified encodable character set.

Manual mode example:

**QRCODE 100,10,L,7,M,0,M1,S1, "ATHE FIRMWARE HAS BEEN UPDATED"**

(Where A: Alphanumeric data)

**QRCODE 100,10,M,7,M,0,M1,S2, "N123456"**

(Where N: Numeric data)

**QRCODE 100,10,Q,7,M,0,M1,S3, "N123456!ATHE FIRMWARE HAS BEEN UPDATED"**

(Where N: Numeric data ; !:Transfer char ; A: Alphanumeric data)

**QRCODE 100,10,H,7,M,0,M1,S3, "B0012Product name"**

(where B: Binary data ; 0012: 12 bytes )

**QRCODE 100,10,M,7,M,0,M1,S3, "K"**

(Where K: Kanji data)



Auto mode example:

**QRCODE 100,10,M,7,A,0, "THE FIRMWARE HAS BEEN UPDATED"**



Note: TDP-643 Plus, TTP-243, TTP-342, TTP-244ME, TTP-342M and TTP-248M series are not supported this QRCODE command.





## Example

| Sample code   | Result  |
|---|---|
| <b>Auto mode example</b>  |   |
| <p><u>General data string</u></p> <p>SIZE 4,2.5<br/>           GAP 0,0<br/>           DIRECTION 1<br/>           CLS<br/>           QRCODE 10,10,H,4,A,0, "ABCabc123"<br/>           QRCODE 160,160,H,4,A,0, "123ABCabc"<br/>           QRCODE 310,310,M,4,A,0,M2, "印表機 ABCabc123"<br/>           PRINT 1,1</p> |  |

|  |   |
|--|---|
| <p><u>Data string including &lt;Enter&gt; character (0Dh, 0Ah)</u></p> <p>SIZE 4,2.5<br/> GAP 0,0<br/> DIRECTION 1<br/> CLS<br/> QRCODE 10,10,H,4,A,0, "ABC&lt;Enter&gt;<br/> abc&lt;Enter&gt;<br/> 123 "<br/> QRCODE 160,160,H,4,A,0, "123&lt;Enter&gt;<br/> ABC&lt;Enter&gt;<br/> abc"<br/> QRCODE 310,310,H,4,A,0, "印表機&lt;Enter&gt;<br/> ABC&lt;Enter&gt;<br/> abc&lt;Enter&gt;<br/> 123"<br/> PRINT 1,1</p> |    |
| <p><u>Data string concatenation (Must be used with DOWNLOAD ... EOP command)</u></p> <p>DOWNLOAD "DEMO.BAS"<br/> SIZE 4,2.5<br/> GAP 0,0<br/> DIRECTION 1<br/> CLS<br/> QRCODE 10,10,H,4,A,0, "ABCabc123" +STR\$(1234)<br/> QRCODE 160,160,H,4,A,0, "123ABCabc" +"1234"<br/> QRCODE 310,310,H,4,A,0, "印表機<br/> ABCabc123"+"1234"+"abcd"<br/> PRINT 1,1<br/> EOP<br/> DEMO</p>                                    |   |
| <p><u>Data string including double quote (") character, please use \" instead of</u></p> <p>SIZE 4,2.5<br/> GAP 0,0<br/> DIRECTION 1<br/> CLS<br/> QRCODE 10,10,H,4,A,0, "ABC\"abc\"123"<br/> QRCODE 160,160,H,4,A,0, "123\"ABC\"abc"<br/> QRCODE 310,310,H,4,A,0, "\"印表機\"ABCabc123"<br/> PRINT 1,1</p>   |  |



| <b>Manual mode</b>   |   |
|--|---|
| <p><u>General data string</u><br/> <b>SIZE 4,2.5</b><br/> <b>GAP 0,0</b><br/> <b>DIRECTION 1</b><br/> <b>CLS</b><br/> <b>QRCODE 10,10,H,4,M,0, "AABC!B0003abc!N123"</b><br/> <b>QRCODE 160,160,H,4,M,0, "N123!AABC!B0003abc"</b><br/> <b>QRCODE 310,310,H,4,M,0, "K 印表機!AABC!B0006abc123"</b><br/> <b>PRINT 1,1</b></p>  |    |
| <p><u>Data string including &lt;Enter&gt; character, &lt;Enter&gt; is an 8-bit byte data</u><br/> <b>SIZE 4,2.5</b><br/> <b>GAP 0,0</b><br/> <b>DIRECTION 1</b><br/> <b>CLS</b><br/> <b>QRCODE 10,10,H,4,M,0,"AABC!B0007&lt;Enter&gt;</b><br/> <b>abc&lt;Enter&gt;</b><br/> <b>!N123"</b><br/> <b>QRCODE 160,160,H,4,M,0,"N123!B0002&lt;Enter&gt;</b><br/> <b>!AABC!B0005&lt;Enter&gt;</b><br/> <b>abc"</b><br/> <b>QRCODE 310,310,H,4,M,0, "K 印表機!B0002&lt;Enter&gt;</b><br/> <b>!AABC!B0010&lt;Enter&gt;</b><br/> <b>abc&lt;Enter&gt;</b><br/> <b>123"</b><br/> <b>PRINT 1,1</b></p> |   |
| <p><u>Data string concatenation (Must be used with DOWNLOAD ... EOP command)</u><br/> <b>DOWNLOAD "A.BAS"</b><br/> <b>SIZE 4,2.5</b><br/> <b>GAP 0,0</b><br/> <b>DIRECTION 1</b><br/> <b>CLS</b><br/> <b>QRCODE 10,10,H,4,M,0,"AABC!B0006abc123!N"+STR\$(1234)</b><br/> <b>QRCODE 160,160,H,4,M,0,"N123!AABC!B0007abc"+"1234"</b><br/> <b>QRCODE 310,310,H,4,M,0, "K 印表機!AABC!B0014abc123"+"1234"+"abcd"</b><br/> <b>PRINT 1,1</b><br/> <b>EOP</b><br/> <b>A</b></p>   |  |

|  |   |
|--|---|
| <p>Data string including double quote (") character, please use \" instead of<br/> <b>SIZE 4,2.5</b><br/> <b>GAP 0,0</b><br/> <b>DIRECTION 1</b><br/> <b>CLS</b><br/> <b>QRCODE 10,10,H,4,M,0, "AABC!B0005\["]abc\["]!N123"</b><br/> <b>QRCODE 160,160,H,4,M,0, "N123!B0001\["]!AABC!B0004\["]abc"</b><br/> <b>QRCODE 310,310,H,4,M,0, "B0001\["]!K 印表</b><br/> <b>機!B0010\["]ABCabc123"</b><br/> <b>PRINT 1,1</b></p> |    |
| <p><u>Smart phone data string</u></p> <p><b>DOWNLOAD "A.BAS"</b><br/> <b>SIZE 3,3</b><br/> <b>GAP 0,0</b><br/> <b>DIRECTION 1</b><br/> <b>CLS</b><br/> <b>QRCODE 10,10,H,7,M,0,M2,S7,"Aabcd"</b><br/> <b>QRCODE 170,170,H,4,M,0, M2,"B0008 繁體中文"</b><br/> <b>QRCODE 300,300, L, 8, M, 0,</b><br/> <b>M2,"B0026http://www.tscprinters.com"</b><br/> <b>PRINT 1,1</b><br/> <b>EOP</b><br/> <b>A</b></p>                  |    |
| <p><u>Data string for parameter [justification] &amp; [area]</u></p> <p><b>SIZE 4,2.5</b><br/> <b>GAP 0,0</b><br/> <b>DIRECTION 1</b><br/> <b>CLS</b><br/> <b>BAR 60,120,200,1</b><br/> <b>BAR 160,20,1,200</b><br/> <b>QRCODE 160,120,H,10,A,0,X100,J5,"123456789"</b><br/> <b>PRINT 1,1</b></p>  |  |
| <p><u>For other [justification] results (J1~J9)</u></p> <div style="display: flex; justify-content: space-around; align-items: center;"> <div data-bbox="204 1585 692 1944">  </div> <div data-bbox="730 1585 1219 1944">  </div> </div>        |   |

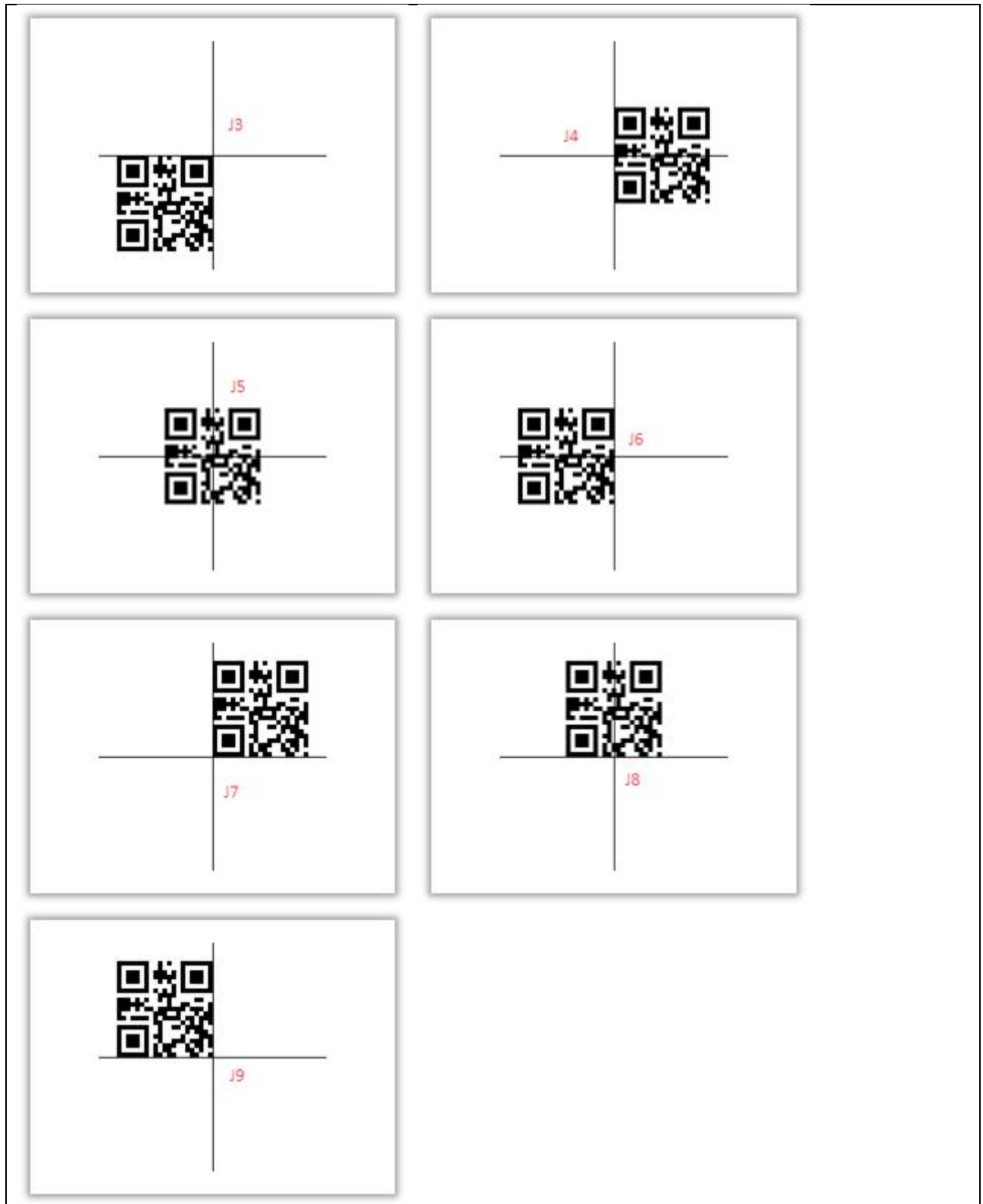

## ● RSS

### Description

This command is used to draw a RSS bar code on the label format.

### Syntax

RSS x,y,"sym",rotate,pixMult,sepHt,"content"

RSS x,y,"RSSEXP",rotate,pixMult,sepHt,segWidth,"content"





RSS x,y,"UCC128CCA",rotate,pixMult,sepHt,linHeight,"content"

RSS x,y,"UCC128CCC",rotate,pixMult,sepHt,linHeight,"content"

| Parameter        | Description   |  |  |              |              |               |                 |               |               |                |                               |               |               |               |               |             |               |             |               |              |               |             |               |                  |                      |                  |                    |
|------------------|---|--|--|--------------|--------------|---------------|-----------------|---------------|---------------|----------------|-------------------------------|---------------|---------------|---------------|---------------|-------------|---------------|-------------|---------------|--------------|---------------|-------------|---------------|------------------|----------------------|------------------|--------------------|
| x                | X-coordinate  |  |  |              |              |               |                 |               |               |                |                               |               |               |               |               |             |               |             |               |              |               |             |               |                  |                      |                  |                    |
| y                | Y-coordinate  |  |  |              |              |               |                 |               |               |                |                               |               |               |               |               |             |               |             |               |              |               |             |               |                  |                      |                  |                    |
| sym              | Symbology type: <table border="1" data-bbox="491 667 1141 1153"> <thead> <tr> <th></th> <th></th> </tr> </thead> <tbody> <tr> <td><b>RSS14</b></td> <td>RSS14</td> </tr> <tr> <td><b>RSS14T</b></td> <td>RSS14 Truncated</td> </tr> <tr> <td><b>RSS14S</b></td> <td>RSS14 Stacked</td> </tr> <tr> <td><b>RSS14SO</b></td> <td>RSS14 Stacked Omnidirectional</td> </tr> <tr> <td><b>RSSLIM</b></td> <td>RSS Limited</td> </tr> <tr> <td><b>RSSEXP</b></td> <td>RSS Expanded</td> </tr> <tr> <td><b>UPCA</b></td> <td>UPC-A</td> </tr> <tr> <td><b>UPCE</b></td> <td>UPC-E</td> </tr> <tr> <td><b>EAN13</b></td> <td>EAN-13</td> </tr> <tr> <td><b>EAN8</b></td> <td>EAN-8</td> </tr> <tr> <td><b>UCC128CCA</b></td> <td>UCC/EAN-128 &amp; CC-A/B</td> </tr> <tr> <td><b>UCC128CCC</b></td> <td>UCC/EAN-128 &amp; CC-C</td> </tr> </tbody> </table> |  |  | <b>RSS14</b> | RSS14        | <b>RSS14T</b> | RSS14 Truncated | <b>RSS14S</b> | RSS14 Stacked | <b>RSS14SO</b> | RSS14 Stacked Omnidirectional | <b>RSSLIM</b> | RSS Limited   | <b>RSSEXP</b> | RSS Expanded  | <b>UPCA</b> | UPC-A         | <b>UPCE</b> | UPC-E         | <b>EAN13</b> | EAN-13        | <b>EAN8</b> | EAN-8         | <b>UCC128CCA</b> | UCC/EAN-128 & CC-A/B | <b>UCC128CCC</b> | UCC/EAN-128 & CC-C |
|                  |   |  |  |              |              |               |                 |               |               |                |                               |               |               |               |               |             |               |             |               |              |               |             |               |                  |                      |                  |                    |
| <b>RSS14</b>     | RSS14   |  |  |              |              |               |                 |               |               |                |                               |               |               |               |               |             |               |             |               |              |               |             |               |                  |                      |                  |                    |
| <b>RSS14T</b>    | RSS14 Truncated   |  |  |              |              |               |                 |               |               |                |                               |               |               |               |               |             |               |             |               |              |               |             |               |                  |                      |                  |                    |
| <b>RSS14S</b>    | RSS14 Stacked   |  |  |              |              |               |                 |               |               |                |                               |               |               |               |               |             |               |             |               |              |               |             |               |                  |                      |                  |                    |
| <b>RSS14SO</b>   | RSS14 Stacked Omnidirectional   |  |  |              |              |               |                 |               |               |                |                               |               |               |               |               |             |               |             |               |              |               |             |               |                  |                      |                  |                    |
| <b>RSSLIM</b>    | RSS Limited   |  |  |              |              |               |                 |               |               |                |                               |               |               |               |               |             |               |             |               |              |               |             |               |                  |                      |                  |                    |
| <b>RSSEXP</b>    | RSS Expanded  |  |  |              |              |               |                 |               |               |                |                               |               |               |               |               |             |               |             |               |              |               |             |               |                  |                      |                  |                    |
| <b>UPCA</b>      | UPC-A   |  |  |              |              |               |                 |               |               |                |                               |               |               |               |               |             |               |             |               |              |               |             |               |                  |                      |                  |                    |
| <b>UPCE</b>      | UPC-E   |  |  |              |              |               |                 |               |               |                |                               |               |               |               |               |             |               |             |               |              |               |             |               |                  |                      |                  |                    |
| <b>EAN13</b>     | EAN-13  |  |  |              |              |               |                 |               |               |                |                               |               |               |               |               |             |               |             |               |              |               |             |               |                  |                      |                  |                    |
| <b>EAN8</b>      | EAN-8   |  |  |              |              |               |                 |               |               |                |                               |               |               |               |               |             |               |             |               |              |               |             |               |                  |                      |                  |                    |
| <b>UCC128CCA</b> | UCC/EAN-128 & CC-A/B  |  |  |              |              |               |                 |               |               |                |                               |               |               |               |               |             |               |             |               |              |               |             |               |                  |                      |                  |                    |
| <b>UCC128CCC</b> | UCC/EAN-128 & CC-C  |  |  |              |              |               |                 |               |               |                |                               |               |               |               |               |             |               |             |               |              |               |             |               |                  |                      |                  |                    |
| rotate           | Rotation (0, 90, 180, and 270 valid)  |  |  |              |              |               |                 |               |               |                |                               |               |               |               |               |             |               |             |               |              |               |             |               |                  |                      |                  |                    |
| pixMult          | Module width in dot (1 to 10 valid)<br>The following barcode height is calculated by printer. <table border="1" data-bbox="491 1279 1141 1619"> <thead> <tr> <th></th> <th></th> </tr> </thead> <tbody> <tr> <td>RSS14</td> <td>33 × pixMult</td> </tr> <tr> <td>RSS14T</td> <td>13 × pixMult.</td> </tr> <tr> <td>RSS14S</td> <td>13 × pixMult.</td> </tr> <tr> <td>RSS14SO</td> <td>33 × pixMult.</td> </tr> <tr> <td>RSSLIM</td> <td>13 × pixMult.</td> </tr> <tr> <td>RSSEXP</td> <td>33 × pixMult.</td> </tr> <tr> <td>EAN8</td> <td>60 × pixMult.</td> </tr> <tr> <td>EAN13</td> <td>74 × pixMult.</td> </tr> <tr> <td>UPCA</td> <td>74 × pixMult.</td> </tr> <tr> <td>UPCE</td> <td>74 × pixMult.</td> </tr> </tbody> </table>   |  |  | RSS14        | 33 × pixMult | RSS14T        | 13 × pixMult.   | RSS14S        | 13 × pixMult. | RSS14SO        | 33 × pixMult.                 | RSSLIM        | 13 × pixMult. | RSSEXP        | 33 × pixMult. | EAN8        | 60 × pixMult. | EAN13       | 74 × pixMult. | UPCA         | 74 × pixMult. | UPCE        | 74 × pixMult. |                  |                      |                  |                    |
|                  |   |  |  |              |              |               |                 |               |               |                |                               |               |               |               |               |             |               |             |               |              |               |             |               |                  |                      |                  |                    |
| RSS14            | 33 × pixMult  |  |  |              |              |               |                 |               |               |                |                               |               |               |               |               |             |               |             |               |              |               |             |               |                  |                      |                  |                    |
| RSS14T           | 13 × pixMult.   |  |  |              |              |               |                 |               |               |                |                               |               |               |               |               |             |               |             |               |              |               |             |               |                  |                      |                  |                    |
| RSS14S           | 13 × pixMult.   |  |  |              |              |               |                 |               |               |                |                               |               |               |               |               |             |               |             |               |              |               |             |               |                  |                      |                  |                    |
| RSS14SO          | 33 × pixMult.   |  |  |              |              |               |                 |               |               |                |                               |               |               |               |               |             |               |             |               |              |               |             |               |                  |                      |                  |                    |
| RSSLIM           | 13 × pixMult.   |  |  |              |              |               |                 |               |               |                |                               |               |               |               |               |             |               |             |               |              |               |             |               |                  |                      |                  |                    |
| RSSEXP           | 33 × pixMult.   |  |  |              |              |               |                 |               |               |                |                               |               |               |               |               |             |               |             |               |              |               |             |               |                  |                      |                  |                    |
| EAN8             | 60 × pixMult.   |  |  |              |              |               |                 |               |               |                |                               |               |               |               |               |             |               |             |               |              |               |             |               |                  |                      |                  |                    |
| EAN13            | 74 × pixMult.   |  |  |              |              |               |                 |               |               |                |                               |               |               |               |               |             |               |             |               |              |               |             |               |                  |                      |                  |                    |
| UPCA             | 74 × pixMult.   |  |  |              |              |               |                 |               |               |                |                               |               |               |               |               |             |               |             |               |              |               |             |               |                  |                      |                  |                    |
| UPCE             | 74 × pixMult.   |  |  |              |              |               |                 |               |               |                |                               |               |               |               |               |             |               |             |               |              |               |             |               |                  |                      |                  |                    |
| sepHt            | Separator row height (1 and 2 valid)<br><a href="#">pixMult times sepHt is the real separator row height. It is calculated by printer.</a>  |  |  |              |              |               |                 |               |               |                |                               |               |               |               |               |             |               |             |               |              |               |             |               |                  |                      |                  |                    |
| segWidth         | Segment width of RSS expanded (even 2 to 22 valid)  |  |  |              |              |               |                 |               |               |                |                               |               |               |               |               |             |               |             |               |              |               |             |               |                  |                      |                  |                    |
| linHeight        | UCC/EAN-128 height in dot (1 to 500 valid)  |  |  |              |              |               |                 |               |               |                |                               |               |               |               |               |             |               |             |               |              |               |             |               |                  |                      |                  |                    |
| content          | Barcode content or string expression<br><a href="#">Content of UPCE must be:</a><br>*00abc0000hij = abhijc, where c = 0-2<br>*00abc00000ij = abcij3<br>*00abcd00000j = abcdj4<br>*00abcde0000j = abcdej where j = 5-9   |  |  |              |              |               |                 |               |               |                |                               |               |               |               |               |             |               |             |               |              |               |             |               |                  |                      |                  |                    |
| <b>Note:</b>     |   |  |  |              |              |               |                 |               |               |                |                               |               |               |               |               |             |               |             |               |              |               |             |               |                  |                      |                  |                    |

- **200 DPI: 1 mm = 8 dots**  
**300 DPI: 1 mm = 12 dots**
- **Recommended max. height of reversed black area is 12 mm at 4 " width. Height of reversed area that is larger than 12 mm may damage the power supply and affect the print quality.**
- **Max. print ratio is different for each printer model. Desktop and industrial printer print ratio is limited to 20% and 30% respectively.**
- **This command has been supported since V6.56 EZ and later firmware.**

## Example

| Sample code  | Result  |
|--|---|
| <pre> SIZE 100 mm,100 mm GAP 0,0 DIRECTION 1 CLS RSS 300,300, "RSS14",0,2,2, "1234567890 ABCDEFGH" RSS 300,300,"RSS14T",90,2,2,"1234567890 ABCDEFGH" RSS 300,300,"RSS14S",180,2,2,"1234567890 ABCDEFGH" RSS 300,300, "RSS14SO",270,2,2, "1234567890 ABCDEFGH" PRINT 1,1 </pre>     |    |
| <pre> SIZE 100 mm,100 mm GAP 0,0 DIRECTION 1 CLS RSS 300,300, "RSSLIM",0,2,2, "1234567890 ABCDEFGH" RSS 300,300, "RSSEXP",90,2,2,22, "1234567890 ABCDEFGH" RSS 300,300, "UPCA",180,2,2, "1234567890 ABCDEFGH" RSS 300,300, "UPCE",270,2,2, "000 ABCDEFGH" PRINT 1,1 </pre>         |   |
| <pre> SIZE 100 mm,100 mm GAP 0,0 DIRECTION 1 CLS RSS 300,300,"EAN13",0,2,2,"123456789012 ABCDEFGH" RSS 300,300,"EAN8",90,2,2,"1234567 ABCDEFGH" RSS 300,300,"UCC128CCA",180,2,2,25,"1234567890 ABCDEFGH" RSS 300,300,"UCC128CCC",270,2,2,25,"1234567890 ABCDEFGH" PRINT 1,1 </pre> |  |
| <pre> SIZE 100 mm, 100 mm GAP 0,0 DIRECTION 1 CLS RSS 300,10, "RSSEXP",90,2,2,12, "81101061414112345628911012012120850100480002140256100 48000310123191000" PRINT 1 </pre>   |  |

| Example of UPCE mode  |  |
|---|--|
| <p>SIZE 4,1<br/>           GAP 0,0<br/>           DIRECTION 1<br/>           CLS<br/>           REM UPCE Rule 1: <b>00abc000hij</b> = abhijc, where c = 0-2<br/>           RSS 10,10,"UPCE",0,2,2,"00120000456 ABCDEFGF"<br/>           RSS 210,10,"UPCE",0,2,2,"001210000456 ABCDEFGF"<br/>           RSS 410,10,"UPCE",0,2,2,"001220000456 ABCDEFGF"<br/>           PRINT 1</p>   |  |
| <p>SIZE 4,1<br/>           GAP 0,0<br/>           DIRECTION 1<br/>           CLS<br/>           REM UPCE Rule 2: <b>00abc0000ij</b> = abcij3<br/>           RSS 10,10,"UPCE",0,2,2,"001230000045 ABCDEFGF"<br/>           PRINT 1<br/>           SIZE 4,1<br/>           CLS<br/>           REM UPCE Rule 3: <b>00abcd0000j</b> = abcdj4<br/>           RSS 10,10,"UPCE",0,2,2,"001234000005 ABCDEFGF"<br/>           PRINT 1</p>   |  |
| <p>SIZE 4,1<br/>           GAP 0,0<br/>           DIRECTION 1<br/>           CLS<br/>           REM UPCE Rule 4: <b>00abcde000j</b> = abcdej where j = 5-9<br/>           RSS 10,10,"UPCE",0,2,2,"001234500005 ABCDEFGF"<br/>           RSS 160,10,"UPCE",0,2,2,"001234500006 ABCDEFGF"<br/>           RSS 310,10,"UPCE",0,2,2,"001234500007 ABCDEFGF"<br/>           RSS 460,10,"UPCE",0,2,2,"001234500008 ABCDEFGF"<br/>           RSS 610,10,"UPCE",0,2,2,"001234500009 ABCDEFGF"<br/>           PRINT 1</p> |  |
| Example of barcode height of EAN8 EAN13 UPCA and UPCE.  |  |
| <p>SIZE 4,2<br/>           GAP 0,0<br/>           DIRECTION 1<br/>           CLS<br/>           RSS 10,10,"EAN8",0,1,1,"1234567 ABCDEFGF"<br/>           RSS 210,10,"EAN8",0,2,1,"1234567 ABCDEFGF"<br/>           RSS 410,10,"EAN8",0,3,1,"1234567 ABCDEFGF"<br/>           PRINT 1</p>  |  |
| <p>SIZE 4,2<br/>           GAP 0,0<br/>           DIRECTION 1<br/>           CLS<br/>           RSS 10,10,"EAN13",0,1,1,"123456789012 ABCDEFGF"<br/>           RSS 210,10,"EAN13",0,2,1,"123456789012 ABCDEFGF"<br/>           RSS 410,10,"EAN13",0,3,1,"123456789012 ABCDEFGF"<br/>           PRINT 1</p>  |  |

|   |  |
|---|--|
| <p> <b>SIZE 4,2</b><br/> <b>GAP 0,0</b><br/> <b>DIRECTION 1</b><br/> <b>CLS</b><br/> <b>RSS 10,10,"UPCA",0,1,1,"12345678901 ABCDEFGH"</b><br/> <b>RSS 210,10,"UPCA",0,2,1,"12345678901 ABCDEFGH"</b><br/> <b>RSS 410,10,"UPCA",0,3,1,"12345678901 ABCDEFGH"</b><br/> <b>PRINT 1</b> </p>    |  |
| <p> <b>SIZE 4,2</b><br/> <b>GAP 0,0</b><br/> <b>DIRECTION 1</b><br/> <b>CLS</b><br/> <b>RSS 10,10,"UPCE",0,1,1,"001200000456 ABCDEFGH"</b><br/> <b>RSS 210,10,"UPCE",0,2,1,"001210000456 ABCDEFGH"</b><br/> <b>RSS 410,10,"UPCE",0,3,1,"001220000456 ABCDEFGH"</b><br/> <b>PRINT 1</b> </p> |  |

## ● REVERSE

### Description

This command reverses a region in image buffer.

### Syntax

**REVERSE** x\_start,y\_start,x\_width,y\_height

| <u>Parameter</u> | <u>Description</u>                               |
|------------------|--|
| x_start          | The x-coordinate of the starting point (in dots) |
| y_start          | The y-coordinate of the starting point (in dots) |
| x_width          | X-axis region width (in dots)                    |
| y_height         | Y-axis region height (in dots)                   |

**Note:**

- **200 DPI : 1 mm = 8 dots**  
**300 DPI : 1 mm = 12 dots**
- **Recommended max. height of reversed black area is 12mm at 4" width. Height of reversed area that is larger than 12 mm may damage the power supply and affect the print quality.**
- **Max. print ratio is different for each printer model. Desktop and industrial printer print ratio is limited to 20% and 30% respectively.**

### Example

| <u>Sample code</u>  | <u>Result</u>  |
|---|--|
| <pre>SIZE 4,2.5 GAP 0,0 DIRECTION 1 CLS TEXT 100,100,"3",0,1,1,"REVERSE" REVERSE 90,90,128,40 PRINT 1,1</pre> |  |



## ● DIAGONAL

### Description

This command is used to draw a diagonal.

### Syntax

**DIAGONAL** x1, y1, x2, y2, thickness

| <u>Parameter</u> | <u>Description</u>                                |
|------------------|---|
| x1               | The x1-coordinate of the starting point (in dots) |
| y1               | The y1-coordinate of the starting point (in dots) |
| x2               | The x2-coordinate of the ending point (in dots)   |
| y2               | The y2-coordinate of the ending point (in dots)   |
| thickness        | Thickness of diagonal                             |

**Note:**

- **200 DPI : 1 mm = 8 dots**
- **300 DPI : 1 mm = 12 dots**

### Example

| <b>Sample code</b>   | <b>Result</b>  |
|--|--|
| <pre>SIZE 4,2.5 GAP 0,0 DIRECTION 1 CLS DIAGONAL 50, 200, 200, 50, 16 DIAGONAL 50, 500, 500, 50, 8 PRINT 1,1</pre> |  |

## ● TEXT

### Description

This command prints text on label.

### Syntax

**TEXT** x,y, " font ",rotation,x-multiplication,y-multiplication,[alignment,] " content "

| <u>Parameter</u>   | <u>Description</u>  |          |  |          |                             |          |                              |          |                              |          |                              |          |                              |          |                                    |          |                                    |          |                                   |                  |  |  |  |              |             |              |             |              |             |              |             |              |             |              |             |              |             |              |             |               |              |              |             |              |             |               |              |               |              |
|--|---|----------|--|----------|-----------------------------|----------|------------------------------|----------|------------------------------|----------|------------------------------|----------|------------------------------|----------|------------------------------------|----------|------------------------------------|----------|-----------------------------------|------------------|--|--|--|--------------|-------------|--------------|-------------|--------------|-------------|--------------|-------------|--------------|-------------|--------------|-------------|--------------|-------------|--------------|-------------|---------------|--------------|--------------|-------------|--------------|-------------|---------------|--------------|---------------|--------------|
| x  | The x-coordinate of the text  |          |  |          |                             |          |                              |          |                              |          |                              |          |                              |          |                                    |          |                                    |          |                                   |                  |  |  |  |              |             |              |             |              |             |              |             |              |             |              |             |              |             |              |             |               |              |              |             |              |             |               |              |               |              |
| y  | The y-coordinate of the text  |          |  |          |                             |          |                              |          |                              |          |                              |          |                              |          |                                    |          |                                    |          |                                   |                  |  |  |  |              |             |              |             |              |             |              |             |              |             |              |             |              |             |              |             |               |              |              |             |              |             |               |              |               |              |
| font   | Font name <table border="1" data-bbox="491 600 1347 1644"> <tbody> <tr> <td><b>0</b></td> <td>Monotype CG Triumvirate Bold Condensed, font width and height is stretchable</td> </tr> <tr> <td><b>1</b></td> <td>8 x 12 fixed pitch dot font</td> </tr> <tr> <td><b>2</b></td> <td>12 x 20 fixed pitch dot font</td> </tr> <tr> <td><b>3</b></td> <td>16 x 24 fixed pitch dot font</td> </tr> <tr> <td><b>4</b></td> <td>24 x 32 fixed pitch dot font</td> </tr> <tr> <td><b>5</b></td> <td>32 x 48 dot fixed pitch font</td> </tr> <tr> <td><b>6</b></td> <td>14 x 19 dot fixed pitch font OCR-B</td> </tr> <tr> <td><b>7</b></td> <td>21 x 27 dot fixed pitch font OCR-B</td> </tr> <tr> <td><b>8</b></td> <td>14 x25 dot fixed pitch font OCR-A</td> </tr> <tr> <td><b>ROMAN.TTF</b></td> <td>Monotype CG Triumvirate Bold Condensed, font width and height proportion is fixed.</td> </tr> <tr> <td colspan="2"><b><i>Following fonts were supported since V6.80 EZ.</i></b></td> </tr> <tr> <td><b>1.EFT</b></td> <td>EPL2 font 1</td> </tr> <tr> <td><b>2.EFT</b></td> <td>EPL2 font 2</td> </tr> <tr> <td><b>3.EFT</b></td> <td>EPL2 font 3</td> </tr> <tr> <td><b>4.EFT</b></td> <td>EPL2 font 4</td> </tr> <tr> <td><b>5.EFT</b></td> <td>EPL2 font 5</td> </tr> <tr> <td><b>A.FNT</b></td> <td>ZPL2 font A</td> </tr> <tr> <td><b>B.FNT</b></td> <td>ZPL2 font B</td> </tr> <tr> <td><b>D.FNT</b></td> <td>ZPL2 font D</td> </tr> <tr> <td><b>E8.FNT</b></td> <td>ZPL2 font E8</td> </tr> <tr> <td><b>F.FNT</b></td> <td>ZPL2 font F</td> </tr> <tr> <td><b>G.FNT</b></td> <td>ZPL2 font G</td> </tr> <tr> <td><b>H8.FNT</b></td> <td>ZPL2 font H8</td> </tr> <tr> <td><b>GS.FNT</b></td> <td>ZPL2 font GS</td> </tr> </tbody> </table> | <b>0</b> | Monotype CG Triumvirate Bold Condensed, font width and height is stretchable | <b>1</b> | 8 x 12 fixed pitch dot font | <b>2</b> | 12 x 20 fixed pitch dot font | <b>3</b> | 16 x 24 fixed pitch dot font | <b>4</b> | 24 x 32 fixed pitch dot font | <b>5</b> | 32 x 48 dot fixed pitch font | <b>6</b> | 14 x 19 dot fixed pitch font OCR-B | <b>7</b> | 21 x 27 dot fixed pitch font OCR-B | <b>8</b> | 14 x25 dot fixed pitch font OCR-A | <b>ROMAN.TTF</b> | Monotype CG Triumvirate Bold Condensed, font width and height proportion is fixed. | <b><i>Following fonts were supported since V6.80 EZ.</i></b> |  | <b>1.EFT</b> | EPL2 font 1 | <b>2.EFT</b> | EPL2 font 2 | <b>3.EFT</b> | EPL2 font 3 | <b>4.EFT</b> | EPL2 font 4 | <b>5.EFT</b> | EPL2 font 5 | <b>A.FNT</b> | ZPL2 font A | <b>B.FNT</b> | ZPL2 font B | <b>D.FNT</b> | ZPL2 font D | <b>E8.FNT</b> | ZPL2 font E8 | <b>F.FNT</b> | ZPL2 font F | <b>G.FNT</b> | ZPL2 font G | <b>H8.FNT</b> | ZPL2 font H8 | <b>GS.FNT</b> | ZPL2 font GS |
| <b>0</b>   | Monotype CG Triumvirate Bold Condensed, font width and height is stretchable  |          |  |          |                             |          |                              |          |                              |          |                              |          |                              |          |                                    |          |                                    |          |                                   |                  |  |  |  |              |             |              |             |              |             |              |             |              |             |              |             |              |             |              |             |               |              |              |             |              |             |               |              |               |              |
| <b>1</b>   | 8 x 12 fixed pitch dot font   |          |  |          |                             |          |                              |          |                              |          |                              |          |                              |          |                                    |          |                                    |          |                                   |                  |  |  |  |              |             |              |             |              |             |              |             |              |             |              |             |              |             |              |             |               |              |              |             |              |             |               |              |               |              |
| <b>2</b>   | 12 x 20 fixed pitch dot font  |          |  |          |                             |          |                              |          |                              |          |                              |          |                              |          |                                    |          |                                    |          |                                   |                  |  |  |  |              |             |              |             |              |             |              |             |              |             |              |             |              |             |              |             |               |              |              |             |              |             |               |              |               |              |
| <b>3</b>   | 16 x 24 fixed pitch dot font  |          |  |          |                             |          |                              |          |                              |          |                              |          |                              |          |                                    |          |                                    |          |                                   |                  |  |  |  |              |             |              |             |              |             |              |             |              |             |              |             |              |             |              |             |               |              |              |             |              |             |               |              |               |              |
| <b>4</b>   | 24 x 32 fixed pitch dot font  |          |  |          |                             |          |                              |          |                              |          |                              |          |                              |          |                                    |          |                                    |          |                                   |                  |  |  |  |              |             |              |             |              |             |              |             |              |             |              |             |              |             |              |             |               |              |              |             |              |             |               |              |               |              |
| <b>5</b>   | 32 x 48 dot fixed pitch font  |          |  |          |                             |          |                              |          |                              |          |                              |          |                              |          |                                    |          |                                    |          |                                   |                  |  |  |  |              |             |              |             |              |             |              |             |              |             |              |             |              |             |              |             |               |              |              |             |              |             |               |              |               |              |
| <b>6</b>   | 14 x 19 dot fixed pitch font OCR-B  |          |  |          |                             |          |                              |          |                              |          |                              |          |                              |          |                                    |          |                                    |          |                                   |                  |  |  |  |              |             |              |             |              |             |              |             |              |             |              |             |              |             |              |             |               |              |              |             |              |             |               |              |               |              |
| <b>7</b>   | 21 x 27 dot fixed pitch font OCR-B  |          |  |          |                             |          |                              |          |                              |          |                              |          |                              |          |                                    |          |                                    |          |                                   |                  |  |  |  |              |             |              |             |              |             |              |             |              |             |              |             |              |             |              |             |               |              |              |             |              |             |               |              |               |              |
| <b>8</b>   | 14 x25 dot fixed pitch font OCR-A   |          |  |          |                             |          |                              |          |                              |          |                              |          |                              |          |                                    |          |                                    |          |                                   |                  |  |  |  |              |             |              |             |              |             |              |             |              |             |              |             |              |             |              |             |               |              |              |             |              |             |               |              |               |              |
| <b>ROMAN.TTF</b>   | Monotype CG Triumvirate Bold Condensed, font width and height proportion is fixed.  |          |  |          |                             |          |                              |          |                              |          |                              |          |                              |          |                                    |          |                                    |          |                                   |                  |  |  |  |              |             |              |             |              |             |              |             |              |             |              |             |              |             |              |             |               |              |              |             |              |             |               |              |               |              |
| <b><i>Following fonts were supported since V6.80 EZ.</i></b> |   |          |  |          |                             |          |                              |          |                              |          |                              |          |                              |          |                                    |          |                                    |          |                                   |                  |  |  |  |              |             |              |             |              |             |              |             |              |             |              |             |              |             |              |             |               |              |              |             |              |             |               |              |               |              |
| <b>1.EFT</b>   | EPL2 font 1   |          |  |          |                             |          |                              |          |                              |          |                              |          |                              |          |                                    |          |                                    |          |                                   |                  |  |  |  |              |             |              |             |              |             |              |             |              |             |              |             |              |             |              |             |               |              |              |             |              |             |               |              |               |              |
| <b>2.EFT</b>   | EPL2 font 2   |          |  |          |                             |          |                              |          |                              |          |                              |          |                              |          |                                    |          |                                    |          |                                   |                  |  |  |  |              |             |              |             |              |             |              |             |              |             |              |             |              |             |              |             |               |              |              |             |              |             |               |              |               |              |
| <b>3.EFT</b>   | EPL2 font 3   |          |  |          |                             |          |                              |          |                              |          |                              |          |                              |          |                                    |          |                                    |          |                                   |                  |  |  |  |              |             |              |             |              |             |              |             |              |             |              |             |              |             |              |             |               |              |              |             |              |             |               |              |               |              |
| <b>4.EFT</b>   | EPL2 font 4   |          |  |          |                             |          |                              |          |                              |          |                              |          |                              |          |                                    |          |                                    |          |                                   |                  |  |  |  |              |             |              |             |              |             |              |             |              |             |              |             |              |             |              |             |               |              |              |             |              |             |               |              |               |              |
| <b>5.EFT</b>   | EPL2 font 5   |          |  |          |                             |          |                              |          |                              |          |                              |          |                              |          |                                    |          |                                    |          |                                   |                  |  |  |  |              |             |              |             |              |             |              |             |              |             |              |             |              |             |              |             |               |              |              |             |              |             |               |              |               |              |
| <b>A.FNT</b>   | ZPL2 font A   |          |  |          |                             |          |                              |          |                              |          |                              |          |                              |          |                                    |          |                                    |          |                                   |                  |  |  |  |              |             |              |             |              |             |              |             |              |             |              |             |              |             |              |             |               |              |              |             |              |             |               |              |               |              |
| <b>B.FNT</b>   | ZPL2 font B   |          |  |          |                             |          |                              |          |                              |          |                              |          |                              |          |                                    |          |                                    |          |                                   |                  |  |  |  |              |             |              |             |              |             |              |             |              |             |              |             |              |             |              |             |               |              |              |             |              |             |               |              |               |              |
| <b>D.FNT</b>   | ZPL2 font D   |          |  |          |                             |          |                              |          |                              |          |                              |          |                              |          |                                    |          |                                    |          |                                   |                  |  |  |  |              |             |              |             |              |             |              |             |              |             |              |             |              |             |              |             |               |              |              |             |              |             |               |              |               |              |
| <b>E8.FNT</b>  | ZPL2 font E8  |          |  |          |                             |          |                              |          |                              |          |                              |          |                              |          |                                    |          |                                    |          |                                   |                  |  |  |  |              |             |              |             |              |             |              |             |              |             |              |             |              |             |              |             |               |              |              |             |              |             |               |              |               |              |
| <b>F.FNT</b>   | ZPL2 font F   |          |  |          |                             |          |                              |          |                              |          |                              |          |                              |          |                                    |          |                                    |          |                                   |                  |  |  |  |              |             |              |             |              |             |              |             |              |             |              |             |              |             |              |             |               |              |              |             |              |             |               |              |               |              |
| <b>G.FNT</b>   | ZPL2 font G   |          |  |          |                             |          |                              |          |                              |          |                              |          |                              |          |                                    |          |                                    |          |                                   |                  |  |  |  |              |             |              |             |              |             |              |             |              |             |              |             |              |             |              |             |               |              |              |             |              |             |               |              |               |              |
| <b>H8.FNT</b>  | ZPL2 font H8  |          |  |          |                             |          |                              |          |                              |          |                              |          |                              |          |                                    |          |                                    |          |                                   |                  |  |  |  |              |             |              |             |              |             |              |             |              |             |              |             |              |             |              |             |               |              |              |             |              |             |               |              |               |              |
| <b>GS.FNT</b>  | ZPL2 font GS  |          |  |          |                             |          |                              |          |                              |          |                              |          |                              |          |                                    |          |                                    |          |                                   |                  |  |  |  |              |             |              |             |              |             |              |             |              |             |              |             |              |             |              |             |               |              |              |             |              |             |               |              |               |              |
| rotation   | The rotation angle of text<br>0 : No rotation<br>90: degrees, in clockwise direction<br>180 : degrees, in clockwise direction<br>270 : degrees, in clockwise direction  |          |  |          |                             |          |                              |          |                              |          |                              |          |                              |          |                                    |          |                                    |          |                                   |                  |  |  |  |              |             |              |             |              |             |              |             |              |             |              |             |              |             |              |             |               |              |              |             |              |             |               |              |               |              |
| x-multiplication   | Horizontal multiplication, up to 10x<br>Available factors: 1~10<br>For "ROMAN.TTF" true type font, this parameter is ignored.<br>For font "0", this parameter is used to specify the width (point) of true type font. 1 point=1/72 inch.  |          |  |          |                             |          |                              |          |                              |          |                              |          |                              |          |                                    |          |                                    |          |                                   |                  |  |  |  |              |             |              |             |              |             |              |             |              |             |              |             |              |             |              |             |               |              |              |             |              |             |               |              |               |              |

|                  |  |
|------------------|--|
| y-multiplication | Vertical multiplication, up to 10x<br>Available factors: 1~10<br>For true type font, this parameter is used to specify the height (point) of true type font. 1 point=1/72 inch.<br>For *.TTF font, x-multiplication and y-multiplication support floating value.<br>(V6.91 EZ) |
| alignment        | Optional. Specify the alignment of text. (V6.73 EZ)<br>0 : Default (Left)<br>1 : Left<br>2 : Center<br>3 : Right   |
| content          | Content of text string   |

**Note:**

- **The internal font (font #1~#5) pitch between TSPL and TSPL2 is different.**
- **Font "0" and "ROMAN.TTF" internal True Type Fonts are available in TSPL2 language printers, but not TSPL language printers.**
- **Please refer to [printer model list](#) for checking TSPL or TSPL2.**
- **If there is any double quote (") within the text, please change it to \["].**
- **If font "0" is used, the font width and font height is stretchable by x-multiplication and y-multiplication parameter. It is expressed by pt (point). 1 point=1/72inch.**
- **EPL2 and ZPL2 are emulating for Eltron<sup>®</sup> and Zebra<sup>®</sup> languages.**

| MODEL                   | Font Type |   |   |   |   |   |   |   |   |           |
|-------------------------|-----------|---|---|---|---|---|---|---|---|-----------|
|                         | 0         | 1 | 2 | 3 | 4 | 5 | 6 | 7 | 8 | ROMAN.TTF |
| TSPL language printers  |           | V | V | V | V | V |   |   |   |           |
| TSPL2 language printers | V         | V | V | V | V | V | V | V | V | V         |
| TTP-248M printer        |           | V | V | V | V | V | V | V |   | V         |

**Example**

## Sample Code

```

SIZE 4,3
GAP 0,0
DIRECTION 1
CLS
TEXT 10,10,"0",0,12,12,"TSPL 2"
TEXT 10,40,"0",0,8,8,"align left"
BAR 0,70,800,4
TEXT 10,110,"0",0,12,12,"FONT 0"
TEXT 10,160,"1",0,1,1,"FONT 1"
TEXT 10,210,"2",0,1,1,"FONT 2"
TEXT 10,260,"3",0,1,1,0,"FONT 3"
TEXT 10,310,"4",0,1,1,0,"FONT 4"
TEXT 10,360,"5",0,1,1,0,"FONT 5"
TEXT 10,410,"6",0,1,1,1,"FONT 6"
TEXT 10,460,"7",0,1,1,1,"FONT 7"
TEXT 10,510,"8",0,1,1,1,"FONT 8"
TEXT 10,560,"ROMAN.TTF",0,12,12,"FONT ROMAN.TTF"

TEXT 400,10,"0",0,12,12,2,"EPL 2"
TEXT 400,40,"0",0,8,8,2,"align center"
TEXT 400,110,"1.EFT",0,1,1,2,"FONT 1"
TEXT 400,160,"2.EFT",0,1,1,2,"FONT 2"
TEXT 400,210,"3.EFT",0,1,1,2,"FONT 3"
TEXT 400,260,"4.EFT",0,1,1,2,"FONT 4"
TEXT 400,310,"5.EFT",0,1,1,2,"FONT 5"

TEXT 800,10,"0",0,12,12,3,"ZPL 2"
TEXT 800,40,"0",0,8,8,3,"align right"
TEXT 800,110,"A.FNT",0,1,1,3,"FONT A"
TEXT 800,160,"B.FNT",0,1,1,3,"FONT B"
TEXT 800,210,"D.FNT",0,1,1,3,"FONT D"
TEXT 800,260,"E8.FNT",0,1,1,3,"FONT E8"
TEXT 800,310,"F.FNT",0,1,1,3,"FONT F"
TEXT 800,360,"G.FNT",0,1,1,3,"FONT G"
TEXT 800,410,"H8.FNT",0,1,1,3,"FONT H8"
TEXT 800,460,"GS.FNT",0,1,1,3,"ABCDEF"
PRINT 1

```

## Result

| TSPL 2<br>align left | EPL 2<br>align center | ZPL 2<br>align right |
|----------------------|-----------------------|----------------------|
| FONT 0               | FONT 1                | FONT A               |
| FONT 1               | FONT 2                | FONT B               |
| FONT 2               | FONT 3                | FONT D               |
| FONT 3               | FONT 4                | FONT E8              |
| FONT 4               | FONT 5                | FONT F               |
| FONT 5               | FONT 6                | FONT G               |
| FONT 6               |                       | FONT H8              |
| FONT 7               |                       | © © TM U S R         |
| FONT 8               |                       |                      |
| FONT ROMAN.TTF       |                       |                      |

## ● BLOCK

### Description

This command prints paragraph on label.

### Syntax

**BLOCK** x,y,width,height, "font",rotation,x-multiplication,y-multiplication,[space,]align,]fit,]  
"content"

| <u>Parameter</u>   | <u>Description</u>   |          |  |          |                             |          |                              |          |                              |          |                              |          |                              |          |                                    |          |                                    |          |                                   |                  |  |  |  |              |             |              |             |              |             |              |             |              |             |              |             |              |             |              |             |               |              |              |             |              |             |               |              |               |              |
|--|--|----------|--|----------|-----------------------------|----------|------------------------------|----------|------------------------------|----------|------------------------------|----------|------------------------------|----------|------------------------------------|----------|------------------------------------|----------|-----------------------------------|------------------|--|--|--|--------------|-------------|--------------|-------------|--------------|-------------|--------------|-------------|--------------|-------------|--------------|-------------|--------------|-------------|--------------|-------------|---------------|--------------|--------------|-------------|--------------|-------------|---------------|--------------|---------------|--------------|
| x  | The x-coordinate of the text   |          |  |          |                             |          |                              |          |                              |          |                              |          |                              |          |                                    |          |                                    |          |                                   |                  |  |  |  |              |             |              |             |              |             |              |             |              |             |              |             |              |             |              |             |               |              |              |             |              |             |               |              |               |              |
| y  | The y-coordinate of the text   |          |  |          |                             |          |                              |          |                              |          |                              |          |                              |          |                                    |          |                                    |          |                                   |                  |  |  |  |              |             |              |             |              |             |              |             |              |             |              |             |              |             |              |             |               |              |              |             |              |             |               |              |               |              |
| width  | The width of block for the paragraph in dots   |          |  |          |                             |          |                              |          |                              |          |                              |          |                              |          |                                    |          |                                    |          |                                   |                  |  |  |  |              |             |              |             |              |             |              |             |              |             |              |             |              |             |              |             |               |              |              |             |              |             |               |              |               |              |
| height   | The height of block for the paragraph in dots  |          |  |          |                             |          |                              |          |                              |          |                              |          |                              |          |                                    |          |                                    |          |                                   |                  |  |  |  |              |             |              |             |              |             |              |             |              |             |              |             |              |             |              |             |               |              |              |             |              |             |               |              |               |              |
| font   | Font name  |          |  |          |                             |          |                              |          |                              |          |                              |          |                              |          |                                    |          |                                    |          |                                   |                  |  |  |  |              |             |              |             |              |             |              |             |              |             |              |             |              |             |              |             |               |              |              |             |              |             |               |              |               |              |
|  | <table border="1"> <tr> <td><b>0</b></td> <td>Monotype CG Triumvirate Bold Condensed, font width and height is stretchable</td> </tr> <tr> <td><b>1</b></td> <td>8 x 12 fixed pitch dot font</td> </tr> <tr> <td><b>2</b></td> <td>12 x 20 fixed pitch dot font</td> </tr> <tr> <td><b>3</b></td> <td>16 x 24 fixed pitch dot font</td> </tr> <tr> <td><b>4</b></td> <td>24 x 32 fixed pitch dot font</td> </tr> <tr> <td><b>5</b></td> <td>32 x 48 dot fixed pitch font</td> </tr> <tr> <td><b>6</b></td> <td>14 x 19 dot fixed pitch font OCR-B</td> </tr> <tr> <td><b>7</b></td> <td>21 x 27 dot fixed pitch font OCR-B</td> </tr> <tr> <td><b>8</b></td> <td>14 x25 dot fixed pitch font OCR-A</td> </tr> <tr> <td><b>ROMAN.TTF</b></td> <td>Monotype CG Triumvirate Bold Condensed, font width and height proportion is fixed.</td> </tr> <tr> <td colspan="2"><b><i>Following fonts were supported since V6.80 EZ.</i></b></td> </tr> <tr> <td><b>1.EFT</b></td> <td>EPL2 font 1</td> </tr> <tr> <td><b>2.EFT</b></td> <td>EPL2 font 2</td> </tr> <tr> <td><b>3.EFT</b></td> <td>EPL2 font 3</td> </tr> <tr> <td><b>4.EFT</b></td> <td>EPL2 font 4</td> </tr> <tr> <td><b>5.EFT</b></td> <td>EPL2 font 5</td> </tr> <tr> <td><b>A.FNT</b></td> <td>ZPL2 font A</td> </tr> <tr> <td><b>B.FNT</b></td> <td>ZPL2 font B</td> </tr> <tr> <td><b>D.FNT</b></td> <td>ZPL2 font D</td> </tr> <tr> <td><b>E8.FNT</b></td> <td>ZPL2 font E8</td> </tr> <tr> <td><b>F.FNT</b></td> <td>ZPL2 font F</td> </tr> <tr> <td><b>G.FNT</b></td> <td>ZPL2 font G</td> </tr> <tr> <td><b>H8.FNT</b></td> <td>ZPL2 font H8</td> </tr> <tr> <td><b>GS.FNT</b></td> <td>ZPL2 font GS</td> </tr> </table> | <b>0</b> | Monotype CG Triumvirate Bold Condensed, font width and height is stretchable | <b>1</b> | 8 x 12 fixed pitch dot font | <b>2</b> | 12 x 20 fixed pitch dot font | <b>3</b> | 16 x 24 fixed pitch dot font | <b>4</b> | 24 x 32 fixed pitch dot font | <b>5</b> | 32 x 48 dot fixed pitch font | <b>6</b> | 14 x 19 dot fixed pitch font OCR-B | <b>7</b> | 21 x 27 dot fixed pitch font OCR-B | <b>8</b> | 14 x25 dot fixed pitch font OCR-A | <b>ROMAN.TTF</b> | Monotype CG Triumvirate Bold Condensed, font width and height proportion is fixed. | <b><i>Following fonts were supported since V6.80 EZ.</i></b> |  | <b>1.EFT</b> | EPL2 font 1 | <b>2.EFT</b> | EPL2 font 2 | <b>3.EFT</b> | EPL2 font 3 | <b>4.EFT</b> | EPL2 font 4 | <b>5.EFT</b> | EPL2 font 5 | <b>A.FNT</b> | ZPL2 font A | <b>B.FNT</b> | ZPL2 font B | <b>D.FNT</b> | ZPL2 font D | <b>E8.FNT</b> | ZPL2 font E8 | <b>F.FNT</b> | ZPL2 font F | <b>G.FNT</b> | ZPL2 font G | <b>H8.FNT</b> | ZPL2 font H8 | <b>GS.FNT</b> | ZPL2 font GS |
| <b>0</b>   | Monotype CG Triumvirate Bold Condensed, font width and height is stretchable   |          |  |          |                             |          |                              |          |                              |          |                              |          |                              |          |                                    |          |                                    |          |                                   |                  |  |  |  |              |             |              |             |              |             |              |             |              |             |              |             |              |             |              |             |               |              |              |             |              |             |               |              |               |              |
| <b>1</b>   | 8 x 12 fixed pitch dot font  |          |  |          |                             |          |                              |          |                              |          |                              |          |                              |          |                                    |          |                                    |          |                                   |                  |  |  |  |              |             |              |             |              |             |              |             |              |             |              |             |              |             |              |             |               |              |              |             |              |             |               |              |               |              |
| <b>2</b>   | 12 x 20 fixed pitch dot font   |          |  |          |                             |          |                              |          |                              |          |                              |          |                              |          |                                    |          |                                    |          |                                   |                  |  |  |  |              |             |              |             |              |             |              |             |              |             |              |             |              |             |              |             |               |              |              |             |              |             |               |              |               |              |
| <b>3</b>   | 16 x 24 fixed pitch dot font   |          |  |          |                             |          |                              |          |                              |          |                              |          |                              |          |                                    |          |                                    |          |                                   |                  |  |  |  |              |             |              |             |              |             |              |             |              |             |              |             |              |             |              |             |               |              |              |             |              |             |               |              |               |              |
| <b>4</b>   | 24 x 32 fixed pitch dot font   |          |  |          |                             |          |                              |          |                              |          |                              |          |                              |          |                                    |          |                                    |          |                                   |                  |  |  |  |              |             |              |             |              |             |              |             |              |             |              |             |              |             |              |             |               |              |              |             |              |             |               |              |               |              |
| <b>5</b>   | 32 x 48 dot fixed pitch font   |          |  |          |                             |          |                              |          |                              |          |                              |          |                              |          |                                    |          |                                    |          |                                   |                  |  |  |  |              |             |              |             |              |             |              |             |              |             |              |             |              |             |              |             |               |              |              |             |              |             |               |              |               |              |
| <b>6</b>   | 14 x 19 dot fixed pitch font OCR-B   |          |  |          |                             |          |                              |          |                              |          |                              |          |                              |          |                                    |          |                                    |          |                                   |                  |  |  |  |              |             |              |             |              |             |              |             |              |             |              |             |              |             |              |             |               |              |              |             |              |             |               |              |               |              |
| <b>7</b>   | 21 x 27 dot fixed pitch font OCR-B   |          |  |          |                             |          |                              |          |                              |          |                              |          |                              |          |                                    |          |                                    |          |                                   |                  |  |  |  |              |             |              |             |              |             |              |             |              |             |              |             |              |             |              |             |               |              |              |             |              |             |               |              |               |              |
| <b>8</b>   | 14 x25 dot fixed pitch font OCR-A  |          |  |          |                             |          |                              |          |                              |          |                              |          |                              |          |                                    |          |                                    |          |                                   |                  |  |  |  |              |             |              |             |              |             |              |             |              |             |              |             |              |             |              |             |               |              |              |             |              |             |               |              |               |              |
| <b>ROMAN.TTF</b>   | Monotype CG Triumvirate Bold Condensed, font width and height proportion is fixed.   |          |  |          |                             |          |                              |          |                              |          |                              |          |                              |          |                                    |          |                                    |          |                                   |                  |  |  |  |              |             |              |             |              |             |              |             |              |             |              |             |              |             |              |             |               |              |              |             |              |             |               |              |               |              |
| <b><i>Following fonts were supported since V6.80 EZ.</i></b> |  |          |  |          |                             |          |                              |          |                              |          |                              |          |                              |          |                                    |          |                                    |          |                                   |                  |  |  |  |              |             |              |             |              |             |              |             |              |             |              |             |              |             |              |             |               |              |              |             |              |             |               |              |               |              |
| <b>1.EFT</b>   | EPL2 font 1  |          |  |          |                             |          |                              |          |                              |          |                              |          |                              |          |                                    |          |                                    |          |                                   |                  |  |  |  |              |             |              |             |              |             |              |             |              |             |              |             |              |             |              |             |               |              |              |             |              |             |               |              |               |              |
| <b>2.EFT</b>   | EPL2 font 2  |          |  |          |                             |          |                              |          |                              |          |                              |          |                              |          |                                    |          |                                    |          |                                   |                  |  |  |  |              |             |              |             |              |             |              |             |              |             |              |             |              |             |              |             |               |              |              |             |              |             |               |              |               |              |
| <b>3.EFT</b>   | EPL2 font 3  |          |  |          |                             |          |                              |          |                              |          |                              |          |                              |          |                                    |          |                                    |          |                                   |                  |  |  |  |              |             |              |             |              |             |              |             |              |             |              |             |              |             |              |             |               |              |              |             |              |             |               |              |               |              |
| <b>4.EFT</b>   | EPL2 font 4  |          |  |          |                             |          |                              |          |                              |          |                              |          |                              |          |                                    |          |                                    |          |                                   |                  |  |  |  |              |             |              |             |              |             |              |             |              |             |              |             |              |             |              |             |               |              |              |             |              |             |               |              |               |              |
| <b>5.EFT</b>   | EPL2 font 5  |          |  |          |                             |          |                              |          |                              |          |                              |          |                              |          |                                    |          |                                    |          |                                   |                  |  |  |  |              |             |              |             |              |             |              |             |              |             |              |             |              |             |              |             |               |              |              |             |              |             |               |              |               |              |
| <b>A.FNT</b>   | ZPL2 font A  |          |  |          |                             |          |                              |          |                              |          |                              |          |                              |          |                                    |          |                                    |          |                                   |                  |  |  |  |              |             |              |             |              |             |              |             |              |             |              |             |              |             |              |             |               |              |              |             |              |             |               |              |               |              |
| <b>B.FNT</b>   | ZPL2 font B  |          |  |          |                             |          |                              |          |                              |          |                              |          |                              |          |                                    |          |                                    |          |                                   |                  |  |  |  |              |             |              |             |              |             |              |             |              |             |              |             |              |             |              |             |               |              |              |             |              |             |               |              |               |              |
| <b>D.FNT</b>   | ZPL2 font D  |          |  |          |                             |          |                              |          |                              |          |                              |          |                              |          |                                    |          |                                    |          |                                   |                  |  |  |  |              |             |              |             |              |             |              |             |              |             |              |             |              |             |              |             |               |              |              |             |              |             |               |              |               |              |
| <b>E8.FNT</b>  | ZPL2 font E8   |          |  |          |                             |          |                              |          |                              |          |                              |          |                              |          |                                    |          |                                    |          |                                   |                  |  |  |  |              |             |              |             |              |             |              |             |              |             |              |             |              |             |              |             |               |              |              |             |              |             |               |              |               |              |
| <b>F.FNT</b>   | ZPL2 font F  |          |  |          |                             |          |                              |          |                              |          |                              |          |                              |          |                                    |          |                                    |          |                                   |                  |  |  |  |              |             |              |             |              |             |              |             |              |             |              |             |              |             |              |             |               |              |              |             |              |             |               |              |               |              |
| <b>G.FNT</b>   | ZPL2 font G  |          |  |          |                             |          |                              |          |                              |          |                              |          |                              |          |                                    |          |                                    |          |                                   |                  |  |  |  |              |             |              |             |              |             |              |             |              |             |              |             |              |             |              |             |               |              |              |             |              |             |               |              |               |              |
| <b>H8.FNT</b>  | ZPL2 font H8   |          |  |          |                             |          |                              |          |                              |          |                              |          |                              |          |                                    |          |                                    |          |                                   |                  |  |  |  |              |             |              |             |              |             |              |             |              |             |              |             |              |             |              |             |               |              |              |             |              |             |               |              |               |              |
| <b>GS.FNT</b>  | ZPL2 font GS   |          |  |          |                             |          |                              |          |                              |          |                              |          |                              |          |                                    |          |                                    |          |                                   |                  |  |  |  |              |             |              |             |              |             |              |             |              |             |              |             |              |             |              |             |               |              |              |             |              |             |               |              |               |              |
| rotation   | The rotation angle of text<br>0 : No rotation<br>90 : degrees, in clockwise direction<br>180 : degrees, in clockwise direction<br>270 : degrees, in clockwise direction  |          |  |          |                             |          |                              |          |                              |          |                              |          |                              |          |                                    |          |                                    |          |                                   |                  |  |  |  |              |             |              |             |              |             |              |             |              |             |              |             |              |             |              |             |               |              |              |             |              |             |               |              |               |              |
| x-multiplication   | Horizontal multiplication, up to 10x<br>Available factors: 1~10<br>For "ROMAN.TTF" true type font, this parameter is ignored.  |          |  |          |                             |          |                              |          |                              |          |                              |          |                              |          |                                    |          |                                    |          |                                   |                  |  |  |  |              |             |              |             |              |             |              |             |              |             |              |             |              |             |              |             |               |              |              |             |              |             |               |              |               |              |

|                  |  |
|------------------|--|
| y-multiplication | For font "0", this parameter is used to specify the width (point) of true type font. 1 point=1/72 inch.<br>Vertical multiplication, up to 10x<br>Available factors: 1~10<br>For true type font, this parameter is used to specify the height (point) of true type font. 1 point=1/72 inch.<br>For *.TTF font, x-multiplication and y-multiplication support floating value. (V6.91 EZ) |
| [space]          | Add or delete the space between lines (in dots)  |
| [align]          | Text alignment. (V6.73 EZ)<br>0 : default (Left)<br>1 : Left<br>2 : Center<br>3 : Right  |
| [fit]            | Shrink the text so that it fits in the block (VA1.97)<br>0 : No shrink (default)<br>1 : Shrink   |
| content          | Data in block. The maximum data length is 4092 bytes.  |

**Note:**

- *The internal font (font #1~#5) pitch between TSPL and TSPL2 is different.*
- *Font "0" and "ROMAN.TTF" internal True Type Fonts are available in TSPL2 language printers, but not TSPL language printers.*
- *If there is any double quote (") within the text, please change it to \["].*
- *If font "0" is used, the font width and font height is stretchable by x-multiplication and y-multiplication parameter. It is expressed by pt (point). 1 point=1/72inch.*
- *\[R] means carriage return character 0x0D.*
- *\[L] means line feed character 0x0A.*
- *This command has been supported since V6.91 EZ and later firmware.*
- *EPL2 and ZPL2 are for emulating Eltron<sup>®</sup> and Zebra<sup>®</sup> languages.*

## Example

| Sample Code  | Result |
|--|--------|
| <pre> SIZE 4,0.5 GAP 0,0 DIRECTION 1 CLS BOX 10,10,800,100,2 BLOCK 15,15,790,90,"0",0,8,8,"We stand behind our products with one of the most comprehensive support programs in the Auto-ID industry." PRINT 1 CLS BOX 10,10,800,100,2 BLOCK 15,15,790,90,"0",0,8,8,20,2,"We stand behind our products with one of the most comprehensive support programs in the Auto-ID industry." PRINT 1 </pre> |        |

| Sample Code for [fit] Parameter   | Result  |
|---|---|
| <p>DATA\$ = "By more than a 2-1 ratio, lawmakers in West Virginia's House of Delegates have approved a bill that would allow gun owners to carry concealed handguns without a permit. The only concealed-carry permits would be for people who are 18-21 years old. Urging her colleagues to approve the bill, its 19-year-old sponsor, Delegate Saira Blair, "</p> <p>SIZE 4,1.5<br/>GAP 0,0<br/>DIRECTION 1<br/>CLS<br/>BLOCK 20,20,500,170,"0",0,10,10,0,0,1,DATA\$<br/>BOX 20,20,500+20,170+20,2<br/>PRINT 1</p> <p>SIZE 4,1.5<br/>GAP 0,0<br/>DIRECTION 1<br/>CLS<br/>BLOCK 20,20,500,170,"0",0,10,10,0,0,0,DATA\$<br/>BOX 20,20,500+20,170+20,2<br/>PRINT 1</p> | <div data-bbox="805 190 1150 304" style="border: 1px solid black; padding: 5px;"> <p>By more than a 2-1 ratio, lawmakers in West Virginia's House of Delegates have</p> </div> <div data-bbox="805 383 1150 497" style="border: 1px solid black; padding: 5px;"> <p>By more than a 2-1 ratio, lawmakers in West Virginia's House of Delegates have approved a bill that would allow gun owners to carry concealed handguns without a permit. The only concealed-carry permits would be for people who are 18-21 years old. Urging her colleagues to approve the bill, its 19-year-old sponsor, Delegate Saira Blair,</p> </div> |

# Status Polling and Immediate Commands

These commands support RS-232, USB and Ethernet.

## ● <ESC>!?

### Description

This command obtains the printer status at any time, even in the event of printer error. An inquiry request is solicited by sending an <ESC> (ASCII 27, escape character) as the beginning control character to the printer. A one byte character is returned, flagging the printer status. A 0 signifies the printer is ready to print labels.

### Syntax

<ESC>!?

| Hex Receive | Printer Status                              |
|-------------|---|
| 00          | Normal                                      |
| 01          | Head opened                                 |
| 02          | Paper Jam                                   |
| 03          | Paper Jam and head opened                   |
| 04          | Out of paper                                |
| 05          | Out of paper and head opened                |
| 08          | Out of ribbon                               |
| 09          | Out of ribbon and head opened               |
| 0A          | Out of ribbon and paper jam                 |
| 0B          | Out of ribbon, paper jam and head opened    |
| 0C          | Out of ribbon and out of paper              |
| 0D          | Out of ribbon, out of paper and head opened |
| 10          | Pause                                       |
| 20          | Printing                                    |
| 80          | Other error                                 |

### See Also

<ESC>!S



## ● <ESC>!C

### Description

This command restarts the printer and omits to run AUTO.BAS. The beginning of the command is an ESCAPE character (ASCII 27).

### Syntax

<ESC>!C

#### *Note:*

- *When printer receives this command, printer will restart itself no matter AUTO.BAS exists or not.*
- *This command has been supported since V5.23 EZ and later firmware.*

### See Also

<ESC>!Q

## ● <ESC>!D

### Description

This command is used to disable immediate command, ex. <ESC>!R <RSC>!? <ESC>!C and so on, which is starting by <ESC>!. The beginning of the command is an ESCAPE character (ASCII 27).

### Syntax

<ESC>!D

**Note:**

*This command has been supported since V6.61 EZ and later firmware.*

### See Also

~!E

## ● <ESC>!O

### Description

This command is used to cancel the PAUSE status of printer. The beginning of the command is an ESCAPE character (ASCII 27).

### Syntax

<ESC>!O

**Note:**

*This command has been supported since V6.93 EZ and later firmware.*

### See Also

<ESC>!P

## ● <ESC>!P

### Description

This command is used to PAUSE the printer. The beginning of the command is an ESCAPE character (ASCII 27).

### Syntax

<ESC>!P

**Note:**

*This command has been supported since V6.93 EZ and later firmware.*

### See Also

<ESC>!O

## ● <ESC>!Q

### Description

This command restarts the printer and omits to run AUTO.BAS. The beginning of the command is an ESCAPE character (ASCII 27).

### Syntax

<ESC>!Q

#### **Note:**

- *If there is no AUTO.BAS inside the printer, the printer will not restart itself.*
- *This command has been supported since V6.72 EZ and later firmware.*

### See Also

<ESC>!C

## ● <ESC>!R

### Description

This command resets the printer. The beginning of the command is an ESCAPE character (ASCII 27). The files downloaded in memory will be deleted. This command cannot be sent in dump mode.

### Syntax

<ESC>!R

### See Also

<ESC>!?

## ● <ESC>!S

### Description

This command obtains the printer status at any time, even in the event of printer error. An inquiry request is solicited by sending an <ESC> (ASCII 27, escape character) as the beginning control character to the printer. 8 bytes will be returned, flagging the printer status.

### Syntax

<ESC>!S

#### Note:

*This command has been supported since V6.29 EZ and later firmware.*

### Response Format

<STX>[4-byte status]<ETX><CR><LF>

| Status Byte #1: message |       |       |       |       |       |       |       |     |       |      |                            |
|-------------------------|-------|-------|-------|-------|-------|-------|-------|-----|-------|------|----------------------------|
| Bit 7                   | Bit 6 | Bit 5 | Bit 4 | Bit 3 | Bit 2 | Bit 1 | Bit 0 | Hex | ASCII | Char | Meaning                    |
| 0                       | 1     | 0     | 0     | 0     | 0     | 0     | 0     | 40  | 64    | @    | Normal                     |
| 0                       | 1     | 1     | 0     | 0     | 0     | 0     | 0     | 60  | 96    | `    | Pause                      |
| 0                       | 1     | 0     | 0     | 0     | 0     | 1     | 0     | 42  | 66    | B    | Backing label              |
| 0                       | 1     | 0     | 0     | 0     | 0     | 1     | 1     | 43  | 67    | C    | Cutting                    |
| 0                       | 1     | 0     | 0     | 0     | 1     | 0     | 1     | 45  | 69    | E    | Printer error              |
| 0                       | 1     | 0     | 0     | 0     | 1     | 1     | 0     | 46  | 70    | F    | Form feed                  |
| 0                       | 1     | 0     | 0     | 1     | 0     | 1     | 1     | 4B  | 75    | K    | Waiting to press print key |
| 0                       | 1     | 0     | 0     | 1     | 1     | 0     | 0     | 4C  | 76    | L    | Waiting to take label      |
| 0                       | 1     | 0     | 1     | 0     | 0     | 0     | 0     | 50  | 80    | P    | Printing batch             |
| 0                       | 1     | 0     | 1     | 0     | 1     | 1     | 1     | 57  | 87    | W    | Imaging                    |

| Status Byte #2: warning |       |       |       |       |       |       |       |     |       |      |  |
|-------------------------|-------|-------|-------|-------|-------|-------|-------|-----|-------|------|--|
| Bit 7                   | Bit 6 | Bit 5 | Bit 4 | Bit 3 | Bit 2 | Bit 1 | Bit 0 | Hex | ASCII | Char | Meaning  |
| 0                       | 1     | 0     | 0     | 0     | 0     | 0     | 0     | 40  | 64    | @    | Normal   |
| 0                       | 1     | 0     | 0     | 0     | 0     | 0     | 1     | 41  | 65    | A    | Paper low<br><small>(since A2.08 EZD)</small>  |
| 0                       | 1     | 0     | 0     | 0     | 0     | 1     | 0     | 42  | 66    | B    | Ribbon low<br><small>(since A2.08 EZD)</small> |
| 0                       | 1     | 0     | 0     | 0     | 1     | 0     | 0     | 44  | 68    | D    | Reversed                                       |
| 0                       | 1     | 0     | 0     | 1     | 0     | 0     | 0     | 48  | 72    | H    | Receive buffer full                            |
| 0                       | 1     | 1     | 0     | 0     | 0     | 0     | 0     | 60  | 96    | `    | Reversed                                       |

| Status Byte #3: error |       |       |       |       |       |       |       |     |       |      |   |
|-----------------------|-------|-------|-------|-------|-------|-------|-------|-----|-------|------|---|
| Bit 7                 | Bit 6 | Bit 5 | Bit 4 | Bit 3 | Bit 2 | Bit 1 | Bit 0 | Hex | ASCII | Char | Meaning   |
| 0                     | 1     | 0     | 0     | 0     | 0     | 0     | 0     | 40  | 64    | @    | Normal  |
| 0                     | 1     | 0     | 0     | 0     | 0     | 0     | 1     | 41  | 65    | A    | Print head overheat                                 |
| 0                     | 1     | 0     | 0     | 0     | 0     | 1     | 0     | 42  | 66    | B    | Stepping motor overheat                             |
| 0                     | 1     | 0     | 0     | 0     | 1     | 0     | 0     | 44  | 68    | D    | Print head error<br><small>(since V7.01 EZ)</small> |
| 0                     | 1     | 0     | 0     | 1     | 0     | 0     | 0     | 48  | 72    | H    | Cutter jam  |
| 0                     | 1     | 0     | 1     | 0     | 0     | 0     | 0     | 50  | 80    | P    | Insufficient memory                                 |

| Status Byte #4: error |       |       |       |       |       |       |       |     |       |      |                 |
|-----------------------|-------|-------|-------|-------|-------|-------|-------|-----|-------|------|-----------------|
| Bit 7                 | Bit 6 | Bit 5 | Bit 4 | Bit 3 | Bit 2 | Bit 1 | Bit 0 | Hex | ASCII | Char | Meaning         |
| 0                     | 1     | 0     | 0     | 0     | 0     | 0     | 0     | 40  | 64    | @    | Normal          |
| 0                     | 1     | 0     | 0     | 0     | 0     | 0     | 1     | 41  | 65    | A    | Paper empty     |
| 0                     | 1     | 0     | 0     | 0     | 0     | 1     | 0     | 42  | 66    | B    | Paper jam       |
| 0                     | 1     | 0     | 0     | 0     | 1     | 0     | 0     | 44  | 68    | D    | Ribbon empty    |
| 0                     | 1     | 0     | 0     | 1     | 0     | 0     | 0     | 48  | 72    | H    | Ribbon jam      |
| 0                     | 1     | 1     | 0     | 0     | 0     | 0     | 0     | 60  | 96    | `    | Print head open |

## Example

### Test <ESC>!S by CommTool via RS-232 port.

The screenshot shows the 'Communication Tools' window. In the 'Transmis' section, 'RS232' is selected under 'Transmissive way'. In the 'Receive' section, 'RS232', 'USB', and 'Ethernet' are all checked under 'Receive way'. The 'Length' is set to 48 and 'Line' to 6. The 'Status' section shows 'COM' and 'CTS' as active. The received data is shown in two sections: a hex view and an ASCII view. The hex view shows several lines of data, with the first three lines highlighted by a red box. The ASCII view shows the corresponding characters: '@@@@', 'F@@@', `@@@', 'B@@@', 'E@@B', and 'E@@b'. A yellow box highlights the hex data '1B 21 53' and the 'Send Hex Data' button. Annotations explain that the hex data means '<ESC>!S' and that the values are returned from the printer.

### Result

```
02 40 40 40 40 03 0D 0A
02 46 40 40 40 03 0D 0A
02 60 40 40 40 03 0D 0A
02 42 40 40 40 03 0D 0A
02 45 40 40 42 03 0D 0A
02 45 40 40 62 03 0D 0A
```

1

2

3

```
@@@@
F@@@
`@@@
B@@@
E@@B
E@@b
```

4

| Item | Meaning   |      |                               |      |                             |      |                                |      |                             |
|------|---|------|-------------------------------|------|-----------------------------|------|--------------------------------|------|-----------------------------|
| 1    | The start character of returned value.  |      |                               |      |                             |      |                                |      |                             |
| 2    | The 4-byte status in Hex.   |      |                               |      |                             |      |                                |      |                             |
| 3    | The end characters of returned value.   |      |                               |      |                             |      |                                |      |                             |
| 4    | 4-byte status in characters.<br>@@@@: The printer is normal for use.<br>F@@@: The printer is feeding label.<br>`@@@: Printer is in PAUSE mode.<br>B@@@: The printer is backing label.<br>E@@B: Printer is in error "Paper Jam".<br>E@@b: Printer is in error "Paper Jam" & "Head open".<br>Note: Paper Jam <Hex 42>  <br>Head open <Hex 60><br>0x42   0x60 = 62 <Hex b> |      |                               |      |                             |      |                                |      |                             |
|      | <table border="1"> <tr> <td>E@@a</td> <td>Paper empty + Print head open</td> </tr> <tr> <td>E@@b</td> <td>Paper jam + Print head open</td> </tr> <tr> <td>E@@d</td> <td>Ribbon empty + Print head open</td> </tr> <tr> <td>E@@h</td> <td>Ribbon jam+ Print head open</td> </tr> </table>  | E@@a | Paper empty + Print head open | E@@b | Paper jam + Print head open | E@@d | Ribbon empty + Print head open | E@@h | Ribbon jam+ Print head open |
| E@@a | Paper empty + Print head open   |      |                               |      |                             |      |                                |      |                             |
| E@@b | Paper jam + Print head open   |      |                               |      |                             |      |                                |      |                             |
| E@@d | Ribbon empty + Print head open  |      |                               |      |                             |      |                                |      |                             |
| E@@h | Ribbon jam+ Print head open   |      |                               |      |                             |      |                                |      |                             |

### See Also

<ESC>!?



## ● <ESC>!F

### Description

This command is used to feed a label. This function is the same as to press the FEED button. The beginning of the command is an ESCAPE character (ASCII 27).

### Syntax

<ESC>!F

**Note:**

*This command has been supported since V7.00 EZ and later firmware.*

## ● <ESC>!. </h2>

### Description

This command can cancel all printing files. The beginning of the command is an ESCAPE character (ASCII 27).

### Syntax

<ESC>!.  
</p></div>

#### **Note:**

***This command has been supported since V7.00 EZ and later firmware.***

## ● ~!@

### Description

This command inquires the mileage of the printer. The integer part of mileage is returned (the decimal part of mileage is not return) to the PC in ASCII characters. The ending character of mileage is 0x0D.

### Syntax

~!@

### Example

~!@

## ● ~!A

### Description

This command inquires the free memory of the printer. The number of bytes of free memory is returned in decimal digits, with 0x0d as ending code of PC.

### Syntax

~!A

### Example

~!A

### See Also

FILES

## ● ~!C

### Description

This command inquires the presence of Real Time Clock. One byte is return from the printer, indicating whether or not the RTC is installed. This command is only for the firmware before V6.xx.

### Syntax

~!C

| Return value | Description           |
|--------------|-----------------------|
| 0            | RTC is not installed. |
| 1            | RTC is installed.     |

### Example

~!C

## ● ~!D

### Description

This command enters the printer into DUMP mode. In DUMP mode, the printer outputs code directly without interpretation.

### Syntax

~!D

### Example

~!D

## ● ~!E

### Description

This command is used to enable immediate command, ex. <ESC>!R <RSC>!? <ESC>!C and so on, which is starting by <ESC>!.

### Syntax

~!E

#### **Note:**

*This command has been supported since V6.61 EZ and later firmware.*

### Example

~!E

### See also

<ESC>!D

## ● ~!F

### Description

This command inquires all about files resident in the printer memory, and fonts installed in the memory module. The filename are returned in ASCII characters. Each file name ends with 0x0D. The ending character is 0x1A. Entering this command multiple times will cycle through the files resident on memory.

### Syntax

~!F

### Example

~!F

### See Also

FILES



## ● ~!!

### Description

The command inquires the code page and country setting of the printer.

### Syntax

~!!

The returned information is given in the following format:

**code page, country code**

ex : 8 bit : 437, 001

7 bit: USA, 001

Regarding the code pages and country codes supported by the printer, please refer to the **CODEPAGE** and **COUNTRY** command respectively.

### Example

~!!

### See Also

COUNTRY, CODEPAGE

## ● ~!T

### Description

This command inquires the model name and number of the printer. This information is returned in ASCII characters.

### Syntax

~ !T

### Example

~!T

## ● <ESC> Y

### Description

This command is used to enable line mode (from EZPL to CPCL) for EZC printer.

### Syntax

<ESC> Y

### Example

<ESC> Y

### See Also

<ESC> Z

## ● <ESC> Z

### Description

This command is used to disable line mode (from CPCL to EZPL) for EZC printer.

### Syntax

<ESC> Z

### Example

<ESC> Z

### See Also

<ESC> Y

# Message Translation Protocols

## ● ~#

### Description

The beginning identifier (~#) of the prompt message is sent from the printer to the KP-200 portable keyboard. The ending identifier is ~&. @0 following the ending identifier ~& is used to instruct keyboard to display the prompt in the first line of LCD display. @1 following the ending identifier ~& is used to instruct keyboard to display the prompt in the first line of LCD display. If @0 or @1 are not present, prompt string will be displayed in first line of LCD and input data will be displayed in second line of LCD.

### Syntax

~#Prompt~&[@0]

~#Prompt~&[@1]

### Example

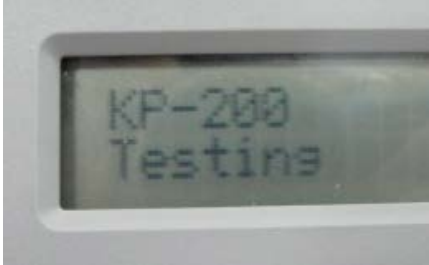
| Sample code  | Result  |
|--|---|
| <pre>DOWNLOAD "A.BAS"<br/>OUT "~#KP-200~&amp;@0"<br/>OUT "~#Testing~&amp;@1"<br/>EOP<br/>A</pre> |  |

### See Also

INPUT, OUT

# Commands for Windows Driver

## ● !B

### Description

This command stores bitmap image data in the memory. Behind the nnn is the bitmap data.

### Syntax

**!Bnnn**

| <u>Parameter</u> | <u>Description</u>  |
|------------------|---|
| nnn              | The number of bytes of image data sent from PC to printer, expressed in 3 decimal digits. |

### Example

**!B100**

### See Also

BITMAP

## ● !J

### Description

This command prints bitmap data at the specified position (in y-direction).

### Syntax

**!Jnnnn**

| <u>Parameter</u> | <u>Description</u>   |
|------------------|--|
| nnn              | Print image at the specified position in y-direction. The position is expressed in 4 decimal digits. |

### Example

**!J0100**

### See Also

FEED

## ● !N

### Description

This command prints a specified number of labels.

### Syntax

**!Nnnn**

| <u>Parameter</u> | <u>Description</u>                            |
|------------------|---|
| nnn              | Specifies the number of copies to be printed. |

### Example

**!N001**



# File Management Commands

## ● DOWNLOAD

### Description

"DOWNLOAD" is a header of the file that is to be saved in the printer's memory. The downloaded files can be divided into two categories: program files and data files (including text data files, PCX graphic files and bitmap font files) The detailed descriptions regarding the download syntax for different files are as follows:

#### Maximum numbers of file saved in DRAM:

50 files for TSPL/TSPL2 language printers

#### Maximum numbers of file saved in Flash memory:

50 files for TSPL language printers

256 files for TSPL2 language printers

Please refer to [printer model list](#) for checking TSPL or TSPL2.

***If "AUTO.BAS" exists in the printer memory, it will be automatically executed upon printer startup. To disable the auto execution function, please follow the procedures below.***

|  |
|--|
| Ignore AUTO.BAS  |
| <b><u>For two buttons desktop printer series</u></b><br>Hold down the <b>PAUSE</b> and <b>FEED</b> buttons and turn on the printer power. Do not release the buttons until the three LEDs flash in turn. Printer will ignore AUTO.BAS and initialize the printer.  |
| <b><u>For one button desktop printer series</u></b><br>Hold the FEED key and power on the switch. Release the FEED key while LED becomes solid green to prevent the printer from running "AUTO.BAS".<br><br>The LED color will be changed as following pattern:<br><br><b>*For firmware version before V3.37 printer:</b><br>Orange → red (5 blinks) → orange (5 blinks) → green (5 blinks) → solid green<br><br><b>*For firmware version after V3.37:</b><br>Orange → red (5 blinks) → orange (5 blinks) → green (5 blinks) → green and orange (5 blinks) → red and orange (5 blinks) → solid green |
| <b><u>For three buttons industrial printer series</u></b><br>Hold the FEED key and power on the switch. The ERROR LED will be on. Printer is now ready to use.   |
| <b><u>For six or two buttons industrial printer series</u></b><br>Hold the PAUSE and FEED keys and power on the switch. "AUTO.BAS" will not be executed after printer initialization, and will now be ready for use.<br>Alternatively, hold the PAUSE key and power on the switch. After sensor calibration, the "AUTO.BAS" will not be executed. Printer is now ready for use.  |

## Syntax

### 1. Download a program file:

**DOWNLOAD [n,] "FILENAME.BAS"**

| <u>Parameter</u> | <u>Description</u>   |
|------------------|--|
| n                | Specify memory used to save downloaded files.<br><b><i>N is ignored:</i></b> Download files to DRAM only. If you would like to save the files from DRAM to Flash memory before turning off power, issue the MOVE command to printer.<br><b><i>F:</i></b> Download files to main board flash memory.<br><b><i>E:</i></b> Download files to expansion memory module. |
| FILENAME.BAS     | The filename resident in printer memory.   |

**Note:**

- ***Filenames are case sensitive.***
- ***File extensions must be ".BAS"***
- ***Filenames must be in 8.3 format.***
- ***It should use with EOP command.***
- ***If memory is not specified, all files will be downloaded to DRAM.***
- ***The priority of AUTO.BAS in each memory device:***
  - A. DRAM > FLASH > CARD (Ext. FLASH) if firmware is before V6.80EZ.***
  - B. DRAM > CARD (Ext. FLASH) > FLASH if firmware is after V6.80EZ (include).***
- ***No Battery is used to back up files in DRAM. Which will be lost in the event printer power is lost.***

### 2. Download a data file:

**DOWNLOAD [n,] "FILENAME",DATA SIZE,DATA CONTENT...**

| <u>Parameter</u> | <u>Description</u>   |
|------------------|--|
| n                | Specify the memory location to save downloaded files.<br><b><i>N is ignored:</i></b> Download files to DRAM only. If you would like to save the files from DRAM to Flash memory before turning off power, issue the MOVE command to printer.<br><b><i>F:</i></b> Download files to main board flash memory.<br><b><i>E:</i></b> Download files to expansion memory module. |
| FILENAME         | The name of data file that will remain resident in the printer memory (case sensitive).  |
| DATA SIZE        | The actual size in bytes of the data file (without header)   |
| DATA CONTENT     | The data which will be downloaded into printer.  |

**Note:**

- ***For text data files, CR (carriage return) 0x0D and LF (Line Feed) 0x0A is the separator of data.***
- ***If memory is not specified, all files will be downloaded to DRAM.***
- ***No Battery is used to back up files in DRAM. Which will be lost in the event printer power is lost.***
- ***When writing a download program, "DOWNLOAD" header must be placed in the beginning of file, and "EOP" must be placed at the end of program.***

- *To run the program, call the main filename without BAS extension or use RUN command to start the download program.*

## Example

**Sample code** (The example program listed below will download to printer SDRAM.)

```
DOWNLOAD "EXAMPLE.BAS"  
SIZE 4,4  
GAP 0,0  
DIRECTION 1  
SET TEAR ON  
CLS  
TEXT 100,100, "3",0,1,1, "EXAMPLE PROGRAM"  
PRINT 1  
EOP
```

## See Also

EOP, RUN, PUTBMP, PUTPCX, INPUT, FILES, ~!F

## ● EOP

### Description

End of program. To declare the start and end of BASIC language commands used in a program, DOWNLOAD "FILENAME.BAS" must be added in the first line of the program, and "EOP" statement at the last line of program.

### Syntax

EOP

### Example

**Sample code** (The example program listed below will download to printer SDRAM.)

```
DOWNLOAD "DEMO.BAS"  
SIZE 4,4  
GAP 0,0  
DIRECTION 1  
SET TEAR ON  
CLS  
TEXT 100,100, "3",0,1,1, "DEMO PROGRAM"  
PRINT 1  
EOP
```

### See Also

DOWNLOAD, INPUT, FILES, ~!F

## ● FILES

### Description

This command prints out the total memory size, available memory size and files lists (or lists the files through RS-232) in the printer memory (both FLASH memory and DRAM).

### Syntax

**FILES**

### Example

| Sample code      | Result  |
|------------------|---|
| <pre>FILES</pre> | <pre>-----<br/>          DRAM FILE (0 FILES)<br/>-----<br/>          PHYSICAL    8192 KBYTES<br/>          AVAILABLE    256 KBYTES<br/>-----<br/><br/>          FLASH FILE (0 FILES)<br/>-----<br/>          PHYSICAL    4096 KBYTES<br/>          AVAILABLE    2560 KBYTES<br/>-----</pre> |

### See Also

~!F, KILL

## ● KILL

### Description

This command deletes a file in the printer memory. The wild card (\*) will delete all files resident in specified DRAM or FLASH memory.

### Syntax

**KILL [n], "FILENAME"**

| <u>Parameter</u> | <u>Description</u>  |
|------------------|---|
| n                | Specify the memory location that files will be deleted.<br><b>N is ignored:</b> Kill files saved in DRAM.<br><b>F:</b> Kill files from main board flash memory.<br><b>E:</b> Kill files from expansion memory module. |
| FILENAME         | The name of data file that will delete in the printer memory (case sensitive)   |

**Note:**

- **If optional parameter n is not specified, firmware will delete the file in DRAM.**
- **Syntax example**
  - KILL "FILENAME" : Delete the specify file in DRAM.**
  - KILL "\*.PCX" : Delete all PCX files in DRAM.**
  - KILL "\*" : Delete all files in DRAM.**
  - KILL F, "FILENAME" : Delete the specify file in FLASH.**
  - KILL E, "\*.PCX" : Delete all PCX file in extension memory card.**
- **For TSPL printers, please send MOVE command to printer after sending KILL command.**
- **Please refer to [printer model list](#) for checking TSPL or TSPL2.**

| Model                     | Support  |               |             |
|---------------------------|----------|---------------|-------------|
|                           | KILL "*" | KILL "*" MOVE | KILL F, "*" |
| TSPL programming printer  | V        | V             |             |
| TSPL2 programming printer | V        |               | V           |

### Example

Users can use printer SELFTEST utility to list printer configurations and files saved in the printer memory, or use the FILES command to print the downloaded file list in printer. Follow the steps below to delete files in the printer memory via parallel port connection.

```
C:\>COPY CON LPT1<ENTER>
FILES<ENTER>
<CTRL><Z><ENTER>
C:\>COPY CON LPT1<ENTER>
KILL "DEMO.BAS " <ENTER>
<CTRL><Z><ENTER>
C:\>COPY CON LPT1<ENTER>
```

FILES<ENTER>  
<CTRL><Z><ENTER>

**Note:** <ENTER> stands for PC keyboard "ENTER" key. <CTRL><Z> means to hold PC keyboard "CTRL" key then press the PC keyboard <Z> key

## See Also

~!F, FILES

## ● MOVE

### Description

This command moves downloaded files from DRAM to FLASH memory.

### Syntax

**MOVE**

### See Also

DOWNLOAD, EOP



## ● RUN

### Description

This command executes a program resident in the printer memory. It is available for TSPL2 language printers only.

### Syntax

**RUN "FILENAME.BAS"**

*Note:*

*\* This command can be replaced to filename that without typing ".BAS".*

*\* TDP-643 Plus, TTP-243, TTP-342, TTP-244ME, TTP-342M and TTP-248M series are not supported this feature*

### Example

| Sample code  | Result              |
|--|---------------------|
| <pre>DOWNLOAD "DEMO.BAS" SIZE 4,4 GAP 0,0 DIRECTION 1 SET TEAR ON CLS TEXT 100,100, "3",0,1,1, "DEMO PROGRAM" PRINT 1 EOP RUN "DEMO.BAS"</pre> | <p>DEMO PROGRAM</p> |
| <pre>DOWNLOAD "DEMO.BAS" SIZE 4,4 GAP 0,0 DIRECTION 1 SET TEAR ON CLS TEXT 100,100, "3",0,1,1, "DEMO PROGRAM" PRINT 1 EOP DEMO</pre>           |                     |

### See Also

DOWNLOAD, EOP

# BASIC Commands and Functions

## ● ABS( )

### Description

This function returns the absolute value of an integer, floating point or variable.

### Syntax

**ABS (VARIABLE)**

### Example

| Sample code   | Result                             |
|---|------------------------------------|
| <pre>DOWNLOAD "TEST.BAS"<br/>SIZE 4,4<br/>GAP 0,0<br/>DIRECTION 1<br/>SET TEAR ON<br/>CLS<br/>A=ABS(-100)<br/>B=ABS(-50.98)<br/>C=-99.99<br/>TEXT 100,100, "3",0,1,1,STR\$(A)<br/>TEXT 100,150, "3",0,1,1,STR\$(B)<br/>TEXT 100,200, "3",0,1,1,STR\$(ABSI)<br/>PRINT 1<br/>EOP<br/>RUN "TEST.BAS"</pre> | <pre>100<br/>50.98<br/>99.99</pre> |

### See Also

DOWNLOAD, EOP

## ● ASC ( )

### Description

This function returns the ASCII code of the character.

### Syntax

ASC (" A ")

### Example

| Sample code  | Result    |
|--|-----------|
| <pre>DOWNLOAD "TEST.BAS" SIZE 4,4 GAP 0,0 DIRECTION 1 SET TEAR ON CLS CODE1=ASC(" A ") TEXT 100,100, " 3 ",0,1,1,STR\$(CODE1) PRINT 1 EOP RUN "TEST.BAS"</pre> | <p>65</p> |

### See Also

DOWNLOAD, EOP, STR\$( )

## ● CHR\$( )

### Description

This function returns the character with the specified ASCII code.

### Syntax

CHR\$(n)

| <u>Parameter</u> | <u>Description</u> |
|------------------|--------------------|
| n                | The ASCII code     |

### Example

| <u>Sample code</u>   | <u>Result</u> |
|--|---------------|
| <pre>DOWNLOAD "TEST.BAS"<br/>SIZE 4,4<br/>GAP 0,0<br/>DIRECTION 1<br/>SET TEAR ON<br/>CLS<br/>A=75<br/>WORD\$=CHR\$(A)<br/>TEXT 100,100, "3",0,1,1,WORD\$<br/>PRINT 1<br/>EOP<br/>RUN "TEST.BAS"</pre> | K             |

### See Also

DOWNLOAD, EOP, STR\$( ), ASC\$( )

## ● XOR\$( )

### Description

This command can encode the original data to a new data by logic XOR.

### Syntax

**XOR\$(data\$,password\$)**

| <u>Parameter</u> | <u>Description</u>                                   |
|------------------|--|
| data\$           | The original data needs to be encoded by password\$. |
| Password\$       | This parameter will be used to create the new data.  |

**Note:**  
*This command has been supported since V6.38 EZ and later firmware.*

### Example

| <u>Sample code</u>   | <u>Result</u>  |
|--|--|
| <pre>data\$="1234"<br/>password\$="ABCD"<br/>encoded\$=XOR\$(data\$,password\$)<br/>deconded\$=XOR\$(encoded\$,password\$)<br/><br/>SIZE 4,0.5<br/>GAP 0,0<br/>CLS<br/>TEXT 10,10,"3",0,1,1, "Encoded data: "+encoded\$<br/>TEXT 10,60, "3",0,1,1, "Decoded data: "+deconded\$<br/>PRINT 1</pre> | <pre>Encoded data: pppp<br/>Decoded data: 1234</pre> |

## ● END

### Description

This command states the end of program.

### Syntax

END

### Example

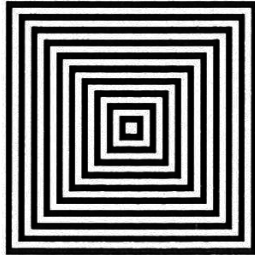
| Sample code  | Result   |
|--|--|
| <pre>DOWNLOAD "DEMO.BAS" SIZE 4,2 GAP 0,0 DIRECTION 1 CLS TEXT 200,60, "4",0,1,1, "END COMMAND TEST" X=300 Y=200 X1=500 Y1=400 GOSUB DR_LINE PRINT 1 END  :DR_LINE FOR I=1 TO 100 STEP 10 BOX X+I,Y+I,X1-I,Y1-I,5 NEXT RETURN EOP DEMO</pre> | <p>END COMMAND TEST</p>  |

### See Also

DOWNLOAD, EOP, GOSUB

## ● EOF( )

### Description

This function is used to detect an opened download file to see whether it has reached the end of file.

### Syntax

EOF (File Handle)

| <u>Parameter</u>    | <u>Description</u> |
|---------------------|--------------------|
| File handle         | Either 0 or 1      |
| <u>Return value</u> | <u>Description</u> |
| None-zero           | End of file        |
| 0                   | Not end of file    |

### Example

#### Sample code

```
DOWNLOAD "DATA",16,COMPUTER
2000

DOWNLOAD "DEMO.BAS"
SIZE 3,3
GAP 0.0,0
DIRECTION 1
CLS
OPEN "DATA",0
SEEK 0,0
Y=110
TEXT 10,10, "3",0,1,1, "*****EOF TEST*****"
:A
Temp$=""
READ 0,ITEM$,P
TEXT 10,Y,"2",0,1,1,ITEM$+"$" +STR$(P)+"[EOF(0)=" +STR$(EOF(0))+"]"
BARCODE 10,Y+25,"39",40,1,0,2,4,"PRICE-"+STR$(P)
Y=Y+100
IF EOF(0)=0 THEN GOTO A
PRINT 1
EOP
DEMO
```

#### Result

\*\*\*\*\*EOF TEST\*\*\*\*\*

COMPUTER\$2000 [ EOF ( 0 ) = 1 ]



PRICE-2000

### See Also

DOWNLOAD, EOP, OPEN, READ, SEEK

## ● OPEN

### Description

This command opens a downloaded file and establishes the file handle. Up to two file handles are supported, thus only up to two files can be opened simultaneously. The file to be opened should be downloaded prior to using this command. When opening a file, the firmware will search automatically to see if the file exists in the on board flash memory or extended memory card. ***\*Since V6.37 EZ, if the file doesn't exist, the printer will create this file in the onboard FLASH.***

### Syntax

**OPEN** [memory ID,] "filename",file handle

| <u>Parameter</u> | <u>Description</u>   |    |               |         |      |   |       |   |      |
|------------------|--|----|---------------|---------|------|---|-------|---|------|
| [memory ID]      | Optional. Open the file in specific memory device. <b><i>*Since V6.68 EZ.</i></b>  |    |               |         |      |   |       |   |      |
|                  | <table border="1"> <thead> <tr> <th>ID</th> <th>Memory device</th> </tr> </thead> <tbody> <tr> <td>Omitted</td> <td>DRAM</td> </tr> <tr> <td>F</td> <td>FLASH</td> </tr> <tr> <td>E</td> <td>CARD</td> </tr> </tbody> </table> | ID | Memory device | Omitted | DRAM | F | FLASH | E | CARD |
| ID               | Memory device  |    |               |         |      |   |       |   |      |
| Omitted          | DRAM   |    |               |         |      |   |       |   |      |
| F                | FLASH  |    |               |         |      |   |       |   |      |
| E                | CARD   |    |               |         |      |   |       |   |      |
| filename         | The file downloaded in the printer memory  |    |               |         |      |   |       |   |      |
| file handle      | Either 0 or 1  |    |               |         |      |   |       |   |      |

### Example

| <u>Sample code</u>   | <u>Result</u>  |
|--|--|
| <pre> DOWNLOAD "DATA.DAT",18,Open file in DRAM. DOWNLOAD F, "DATA.DAT",19,Open file in FLASH. DOWNLOAD "TEST.BAS" data1\$="" data2\$="" data3\$="" OPEN "DATA.DAT",0 READ 0,data1\$ CLOSE 0 OPEN F, "DATA.DAT",0 READ 0,data2\$ CLOSE 0 KILL F, "*" OPEN "NEW.DAT",0 SEEK 0,0 WRITE 0, "Auto create a new file in FLASH." SEEK 0,0 READ 0,data3\$ CLOSE 0 SIZE 4,1 GAP 0,0 CLS TEXT 10,10,"3",0,1,1,data1\$ TEXT 10,60,"3",0,1,1,data2\$ TEXT 10,110,"3",0,1,1,data3\$ PRINT 1 EOP TEST </pre> | <pre> Open file in DRAM. Open file in FLASH. Auto create a new file in FLASH. </pre> |



**See Also**

DOWNLOAD, EOP, READ, WRITE, SEEK, CLOSE

## ● CLOSE

### Description

Close the file handle which is open by command OPEN.

### Syntax

**CLOSE** file handle

| <u>Parameter</u> | <u>Description</u> |
|------------------|--------------------|
| file handle      | Either 0 or 1      |

### Example

See the example in command OPEN.

## ● WRITE

### Description

This command writes data to a downloaded data file. Two files can be open simultaneously, by virtue of printer support for two file handles.

### Syntax

**WRITE** file handle,variables

| <u>Parameter</u> | <u>Description</u>                      |
|------------------|---|
| file handle      | 0 or 1                                  |
| variables        | string, integer or float point variable |

### See Also

READ, DOWNLOAD, EOP, OPEN, EOF, LOF, SEEK, FREAD\$()

## ● READ

### Description



This command reads data from downloaded data file.

### Syntax

**READ** file handle,variables

| <u>Parameter</u> | <u>Description</u>                      |
|------------------|---|
| file handle      | 0 or 1                                  |
| variables        | string, integer or float point variable |

### Example

| <u>Sample code</u>   | <u>Result</u>   |
|--|---|
| <pre>DOWNLOAD "DATA1",20,COMPUTER 2000 12 DOWNLOAD "DATA2",16,Mouse 900 93 DOWNLOAD "DEMO.BAS" SIZE 3,1 GAP 0,0 DIRECTION 1 I=0 Y=100 OPEN "DATA1",0 OPEN "DATA2",1 SEEK 0,0 SEEK 1,0 :Start CLS TEXT 10,10,"3",0,1,1,"*****READ COMMAND TEST*****" TEXT 10,50,"3",0,1,1,"OPEN-READ DATA"+STR\$(I+1) ITEM\$="" READ I,ITEM\$,P,Q TEXT 10,Y,"2",0,1,1,ITEM\$+"\$" +STR\$(P) BARCODE 10,Y+25,"39",40,1,0,2,4,"PRICE*"+STR\$(Q)+ "+STR\$(P*Q) Y=Y+100 PRINT 1 Y=100 IF I&lt;=1 THEN IF EOF(I)=1 THEN I=I+1 GOTO Start ELSE GOTO Start ENDIF ELSE END ENDIF EOP DEMO</pre> | <pre>*****READ COMMAND TEST***** OPEN-READ DATA3 \$900  PRICE*93=83700 *****READ COMMAND TEST***** OPEN-READ DATA2 Mouse\$900  PRICE*93=83700 *****READ COMMAND TEST***** OPEN-READ DATA1 COMPUTER\$2000  PRICE*12=24000</pre> |

### See Also

DOWNLOAD, EOP, OPEN, EOF, LOF, SEEK, FREAD\$()

## ● SEEK

### Description

This command shifts the specified file pointer to a certain position.

### Syntax

**SEEK file handle,offset**

| <u>Parameter</u> | <u>Description</u>  |
|------------------|---|
| file handle      | 0 or 1  |
| offset           | the offset characters which are shifted to a new position |

### Example

| <u>Sample code</u>   | <u>Result</u>  |
|--|--|
| <pre>DOWNLOAD "DATA",12,1234567890 DOWNLOAD "TEST.BAS" SIZE 4,1.5 GAP 0,0 DIRECTION 1 REFERENCE 0,0 CLS OPEN "DATA",0 SEEK 0,4 READ 0,Num\$ TEXT 100,10,"3",0,1,1,"SEEK COMMAND TEST" BAR 100,40,300,4 TEXT 100,60,"3",0,1,1,"SHIFT 4 CHARACTERS" TEXT 100,110,"3",0,1,1,Num\$ BAR 100,140,300,4 SEEK 0,0 READ 0,Num\$ TEXT 100,160,"3",0,1,1,"SHIFT 0 CHARACTERS" TEXT 100,210,"3",0,1,1,Num\$ PRINT 1 EOP TEST</pre> | <pre>SEEK COMMAND TEST SHIFT 4 CHARACTERS 567890 SHIFT 0 CHARACTERS 1234567890</pre> |

### See Also

DOWNLOAD, EOP, OPEN, READ, EOF, LOF, FREAD\$()

## ● LOF( )

### Description

This function returns the size of the specified file.

### Syntax

LOF("FILENAME")

| <u>Parameter</u> | <u>Description</u>                         |
|------------------|--|
| FILENAME         | The file downloaded in the printer memory. |

### Example

| <u>Sample code</u>  | <u>Result</u>  |
|---|--|
| <pre>DOWNLOAD "DATA1",10,1234567890 DOWNLOAD "DATA2",15,ABCDEFGHIJKLMNO  DOWNLOAD "LofTest.BAS" SIZE 4,1.5 GAP 0,0 DIRECTION 1 CLS OPEN "DATA1",0 OPEN "DATA2",1 TEXT 10,20,"4",0,1,1,"LOF() FUNCTION TEST" J=LOF("DATA1") K=LOF("DATA2") TEXT 10,140,"3",0,1,1,"DATA1 IS: "+STR\$(J)+"Bytes" TEXT 10,200,"3",0,1,1,"DATA2 IS: "+STR\$(K)+"Bytes" PRINT 1 EOP LofTest</pre> | <pre>LOF( ) FUNCTION TEST  DATA1 IS: 10 Bytes DATA2 IS: 15 Bytes</pre> |

### See Also

DOWNLOAD, EOP, OPEN, READ, EOF, SEEK, FREAD\$( )

## ● LOC( )

### Description

This function returns the current read/write position within an open file.

### Syntax

LOC(file handle)

| <u>Parameter</u> | <u>Description</u> |
|------------------|--------------------|
| file handle      | 0 or 1             |

**Note:**  
*This command has been supported since V6.86 EZ and later firmware.*

### Example

| <u>Sample code</u>   | <u>Result</u>                            |
|--|--|
| <pre>DOWNLOAD "DATA.DAT",30,12345678 12345678 12345678  DOWNLOAD "TEST.BAS" str1\$ = "" location = 0 OPEN "DATA.DAT",0 READ 0,str1\$ location = LOC(0) CLOSE 0 SIZE 4,1 GAP 0,0 CLS TEXT 10,10,"3",0,1,1,"str1\$: "+str1\$ TEXT 10,60,"3",0,1,1,"Location:"+STR\$(location) PRINT 1 EOP TEST</pre> | <pre>str1\$: 12345678  Location:10</pre> |

## ● FREAD\$( )

### Description

This function reads a specified number of bytes of data from a file.

### Syntax

**FREAD\$(file handle,byte)**

| <u>Parameter</u> | <u>Description</u>         |
|------------------|----------------------------|
| file handle      | 0 or 1                     |
| byte             | Number of bytes to be read |

### Example

| <u>Sample code</u>  | <u>Result</u>  |
|---|--|
| <pre>DOWNLOAD "DATA1",10,1234567890 DOWNLOAD "DATA2",15,ABCDEFGHIJKLMNO DOWNLOAD "OPEN2.BAS" SIZE 4,1 GAP 0,0 DIRECTION 1 CLS OPEN "DATA1",0 OPEN "DATA2",1 SEEK 0,0 SEEK 1,0 Y\$=FREAD\$(0,6) Z\$=FREAD\$(1,6) TEXT 10,100,"3",0,1,1,"FREAD\$(0,6) IS: " +Y\$ TEXT 10,150,"3",0,1,1,"FREAD\$(1,6) IS: " +Z\$ PRINT 1 EOP OPEN2</pre> | <pre>FREAD\$(0,6) IS: 123456 FREAD\$(1,6) IS: ABCDEF</pre> |

### See Also

DOWNLOAD, EOP, OPEN, READ, EOF, LOF(), SEEK



## ● PUT

### Description

One byte is appended into file.

### Syntax

PUT file handle,var1\$[, var2\$][,var3\$][, ...]

PUT file handle,var1[, var2][,var3][, ...]

PUT file handle,var1\$[, var2\$][,var3\$][, ...]

| <u>Parameter</u> | <u>Description</u>  |
|------------------|---------------------|
| file handle      | 0 or 1              |
| var\$            | Data is a character |
| var              | Data is ASCII value |

**Note:**  
*This command has been supported since V6.91 EZ and later firmware.*

### Example

#### Sample code

```
DOWNLOAD "DATA1",10,1234567890
DOWNLOAD "TEST.BAS"
str1$ = ""
str2$ = ""
OPEN "DATA1",0
SEEK 0,0
READ 0,str1$
PUT 0,"a","B",49
SEEK 0,0
READ 0,str2$
CLOSE 0

SIZE 4,0.5
GAP 0,0
CLS
TEXT 10, 10,"3",0,1,1,"Original data in DATA1: "+str1$
TEXT 10, 60,"3",0,1,1,"New data in Data1: "+str2$
PRINT 1
EOP
TEST
```

#### Result

```
Original data in DATA1: 1234567890
New data in Data1: 1234567890aB1
```

### See Also

DOWNLOAD, EOP, OPEN, READ, EOF, LOF(), SEEK, GET

## ● GET

### Description

Get one byte from file.

### Syntax

GET file handle,var1\$[,var2\$][,var3\$][, ...]

GET file handle,var1[,var2][,var3][, ...]

GET file handle,var1\$[,var2\$][,var3][, ...]

| <u>Parameter</u> | <u>Description</u> |
|------------------|--------------------|
| file handle      | 0 or 1             |
| var\$            | Get a character    |
| var              | Get ASCII value    |

**Note:**  
*This command has been supported since V6.91 EZ and later firmware.*

### Example

#### Sample code

```
DOWNLOAD "DATA1",10,1234567890
DOWNLOAD "TEST.BAS"
a$=""
b$=""
c=0
d$=""
e$=""
OPEN "DATA1",0
SEEK 0,0
GET 0,a$,b$,c
SEEK 0,0
FOR I=1 TO 5
GET 0,d$
e$=e$+d$
NEXT

SIZE 4,0.5
GAP 0,0
CLS
TEXT 10,10,"3",0,1,1,"The first 3 characters in DATA1: "+a$+b$+" (" +STR$(c)+")"
TEXT 10,60,"3",0,1,1,"The first 5 characters in DATA1: "+e$
PRINT 1
EOP
TEST
```

#### Result

```
The first 3 characters in DATA1: 12 (51)
The first 5 characters in DATA1: 12345
```

### See Also

DOWNLOAD, EOP, OPEN, READ, EOF, LOF(), SEEK, PUT

## ● COPY

### Description

Copy the existed file from CARD to FLASH.

### Syntax

**COPY** [memory ID of source,] "filename of source",[memory ID of new file,] "new filename"

| <u>Parameter</u>      | <u>Description</u>   |    |               |         |      |   |       |   |      |
|-----------------------|--|----|---------------|---------|------|---|-------|---|------|
| memory ID of source   | Optional.<br><table border="1"><thead><tr><th>ID</th><th>Memory device</th></tr></thead><tbody><tr><td>Omitted</td><td>DRAM</td></tr><tr><td>F</td><td>FLASH</td></tr><tr><td>E</td><td>CARD</td></tr></tbody></table> | ID | Memory device | Omitted | DRAM | F | FLASH | E | CARD |
| ID                    | Memory device  |    |               |         |      |   |       |   |      |
| Omitted               | DRAM   |    |               |         |      |   |       |   |      |
| F                     | FLASH  |    |               |         |      |   |       |   |      |
| E                     | CARD   |    |               |         |      |   |       |   |      |
| source filename       | The file in CARD which you want to copy to on board FLASH.   |    |               |         |      |   |       |   |      |
| Memory ID of new file | Optional.<br><table border="1"><thead><tr><th>ID</th><th>Memory device</th></tr></thead><tbody><tr><td>Omitted</td><td>DRAM</td></tr><tr><td>F</td><td>FLASH</td></tr></tbody></table>                                 | ID | Memory device | Omitted | DRAM | F | FLASH |   |      |
| ID                    | Memory device  |    |               |         |      |   |       |   |      |
| Omitted               | DRAM   |    |               |         |      |   |       |   |      |
| F                     | FLASH  |    |               |         |      |   |       |   |      |
| new filename          | The new filename you want to use in the on board FLASH.  |    |               |         |      |   |       |   |      |

**Note: This command has been supported since V6.78 EZ and later firmware.**

### Example

#### Sample Code

```
DOWNLOAD "DATA_D.DAT",105,We stand behind our products with one of the most comprehensive support
programs in the Auto-ID industry.
DOWNLOAD "TEST.BAS"
KILL F,"*"
COPY "DATA_D.DAT",F,"DATA_F.DAT"
OPEN "DATA_F.DAT",0
SEEK 0,0
data$=FREAD$(0,LOF("DATA_F.DAT"))
CLOSE 0
SIZE 4,0.5
GAP 0,0
CLS
BOX 10,10,800,100,2
BLOCK 15,15,790,90,"0",0,8,8,20,2,data$
PRINT 1
EOP
TEST
```

#### Result

203 dpi

We stand behind our products with one of the most comprehensive support programs in  
the Auto-ID industry.

300 dpi

We stand behind our products with one of the most  
comprehensive support programs in the Auto-ID industry.

### See Also

DOWNLOAD, EOP, OPEN, FREAD\$, EOF, LOF(), SEEK, CLOSE

## ● FOR...NEXT LOOP

### Description

Loop is used to execute one or more lines of program repetitively. A loop counter value specifies the number of executions. Nested loops are allowed (up to 39 nested loops) in this printer. Jumping out in the middle of the FOR...NEXT loop is prohibited.

### Syntax

```
FOR variable = start TO end STEP increment
    statement; start < end
[EXITFOR]
NEXT
```

| <u>Parameter</u> | <u>Description</u>                              |
|------------------|---|
| variable         | The variable name (up to 8 characters)          |
| start            | Integer or floating point numbers               |
| end              | Integer or floating point numbers               |
| increment        | Integer or floating point, positive or negative |
| EXITFOR          | Exit for loop                                   |

### Example

| <u>Sample code</u>   | <u>Result</u>  |
|--|--|
| <pre>DOWNLOAD "TEST.BAS" SIZE 4,2.5 GAP 0,0 CLS FOR I=1 TO 10 STEP 1 TEXT 100,10+30*(I-1),"3",0,1,1,STR\$(I) NEXT  FOR I=1 TO 1000 STEP 100 TEXT 200,10+((I-1)/10)*3,"3",0,1,1,STR\$(I) NEXT  FOR I=110 TO 10 STEP -10 TEXT 300,10+(ABS(I-110))*3,"3",0,1,1,STR\$(I) NEXT  FOR I=1 TO 5 STEP 0.5 IF I-INT(I)=0 THEN Y=10+60*(I-1) ELSE Y=Y+30 TEXT 400,Y,"3",0,1,1,STR\$(I) NEXT  PRINT 1 EOP TEST</pre> | <pre> 1      1      110    1 2      101    100    1.5 3      201    90     2 4      301    80     2.5 5      401    70     3 6      501    60     3.5 7      601    50     4 8      701    40     4.5 9      801    30     5 10     901    20 10     901    20</pre> |

### See Also

DOWNLOAD, EOP

## ● WHILE...WEND

### Description

Executes a series of statements as long as a given condition is True. Nested loops are allowed (up to 39 nested loops) in this printer.

### Syntax

```
WHILE condition
[statement]
WEND
```

| Parameter   | Description  |
|---|--|
| condition   | Available relational operator: <, >, =, <=, >=, <><br><i>*Relational operator &lt;&gt;, not equal, was supported since V5.10 EZ.</i> |
| Statement   | One or more statements executed while condition is True.   |
| <b>Note:</b><br><i>This command has been supported since V5.10 EZ and later firmware.</i> |  |

### Example

| Sample Code   | Result   |
|---|--|
| <pre>DOWNLOAD "TEST.BAS" I=0 TOTAL=0 WHILE I&lt;100 I=I+1 TOTAL=TOTAL+I WEND SIZE 4,0.5 GAP 0,0 CLS TEXT 10,10, "3",0,1,1, "1+2+3+ ... + 100 = " +STR\$(TOTAL) PRINT 1 EOP TEST</pre>   | <pre>1+2+3+ ... + 100 = 5050</pre>                     |
| <pre>DOWNLOAD "TEST.BAS" data\$="" SIZE 4,0.3 GAP 0,0 DIRECTION 1 INPUT "Data: ",data\$ WHILE data\$ &lt;&gt; "Quit" CLS TEXT 10,10, "3",0,1,1, "Data: "+data\$ PRINT 1 INPUT "Data: ",data\$ WEND CLS TEXT 10,10, "3",0,1,1, "Quit BAS" PRINT 1 EOP TEST 12345 67890 quit Quit</pre> | <pre>Quit BAS Data: quit Data: 67890 Data: 12345</pre> |

## ● DO...LOOP

### Description

Repeats a block of statement while a condition is True.

### Syntax

```
DO
    [statement]
    [EXITDO]
    [statement]
LOOP
```

```
DO WHILE condition
    [statement]
    [EXITDO]
    [statement]
LOOP
```

```
DO UNTIL condition
    [statement]
    [EXITDO]
    [statement]
LOOP
```

```
DO
    [statement]
    [EXITDO]
    [statement]
LOOP WHILE condition
```

```
DO
    [statement]
    [EXITDO]
    [statement]
LOOP UNTIL condition
```

| <u>Parameter</u>   | <u>Description</u>   |
|--|--|
| condition  | Available relational operator: <, >, =, <=, >=, <><br><b>*Relational operator &lt;&gt;, not equal, was supported since V5.10 EZ.</b> |
| Statement  | One or more statements executed while condition is True.   |
| EXITDO   | Exit loop  |
| <b>Note:</b><br><b><i>This command has been supported since V5.10 EZ and later firmware.</i></b> |  |

## Example

| Sample Code   | Result                      |
|---|-----------------------------|
| <pre> DOWNLOAD "TEST.BAS" I=0 TOTAL=0 DO I=I+1 TOTAL=TOTAL+I IF I=100 THEN EXITDO LOOP SIZE 4,0.5 GAP 0,0 CLS TEXT 10,10, "3",0,1,1, "1+2+3+ ... + 100 = " + STR\$(TOTAL) PRINT 1 EOP TEST           </pre> | $1+2+3+ \dots + 100 = 5050$ |
| <pre> DOWNLOAD "TEST.BAS" I=0 TOTAL=0 DO WHILE I&lt;=100 TOTAL=TOTAL+I I=I+1 LOOP SIZE 4,0.5 GAP 0,0 CLS TEXT 10,10, "3",0,1,1, "1+2+3+ ... + 100 = " + STR\$(TOTAL) PRINT 1 EOP TEST           </pre>      | $1+2+3+ \dots + 100 = 5050$ |
| <pre> DOWNLOAD "TEST.BAS" I=0 TOTAL=0 DO UNTIL I&gt;100 TOTAL=TOTAL+I I=I+1 LOOP SIZE 4,0.5 GAP 0,0 CLS TEXT 10,10, "3",0,1,1, "1+2+3+ ... + 100 = " + STR\$(TOTAL) PRINT 1 EOP TEST           </pre>       | $1+2+3+ \dots + 100 = 5050$ |

|  |                             |
|--|-----------------------------|
| <pre> <b>DOWNLOAD "TEST.BAS"</b> I=0 TOTAL=0 DO TOTAL=TOTAL+I I=I+1 LOOP WHILE I&lt;101 SIZE 4,0.5 GAP 0,0 CLS TEXT 10,10, "3",0,1,1, "1+2+3+ ... + 100 =" + STR\$(TOTAL) PRINT 1 EOP TEST </pre>        | $1+2+3+ \dots + 100 = 5050$ |
| <pre> <b>DOWNLOAD "TEST.BAS"</b> I=0 TOTAL = 0 DO TOTAL = TOTAL + I I=I+1 LOOP UNTIL I&gt;100 SIZE 4,0.5 GAP 0,0 CLS TEXT 10,10, "3",0,1,1, "1+2+3+ ... + 100 = " + STR\$(TOTAL) PRINT 1 EOP TEST </pre> | $1+2+3+ \dots + 100 = 5050$ |



## ● IF...THEN...ELSE...ENDIF LOOP

### Description

Use IF...THEN block to execute one or more statements conditionally. Either a single-line syntax or multiple-line “block” syntax can be used.

Note: TDP-643 Plus, TTP-243, TTP-342, TTP-244ME and TTP-342M series are not supported multiple-line form.

### Syntax

*IF condition THEN statement*

*Note the single-line form of IF ...THEN does not use an ENDIF statement.*

Or

```
IF condition THEN                (TSPL2 printers only)
    Statements
ENDIF
```

Or

```
IF condition THEN                (TSPL2 printers only)
    Statements
ELSE
    Statements
ENDIF
```

Or

```
IF condition 1 THEN              (TSPL2 printers only)
    Statement block 1
ELSEIF condition 2 THEN
    Statement block 2
    . . .
ELSEIF condition n THEN
    Statement block n
ENDIF
```

*\*The syntax of IF...THEN...ELSE requires that the command be typed in one single line in less than 255 characters.*

| <u>Parameter</u> | <u>Description</u>   |
|------------------|--|
| condition        | Available relational operator: <, >, =, <=, >=, <><br><i>*Relational operator &lt;&gt;, not equal, was supported since V5.10 EZ.</i> |
| Statement        | Only one statement is available in   |

## Example

| Sample Code   | Result  |
|---|---|
| <pre> DOWNLOAD "DEMO.BAS" SIZE 4,4 GAP 0,0 DIRECTION 1 CLS A=0 B=0 C=0 D=0 E=0 F=0 G=0 H=0 J=0 K=0 L=0 FOR I=1 TO 100 IF I-INT(I/1)*1=0 THEN A=A+I IF I-INT(I/2)*2=1 THEN B=B+I ELSE C=C+I IF I-INT(I/3)*3=0 THEN D=D+I ENDIF IF I-INT(I/5)*5=0 THEN E=E+I ELSE F=F+I ENDIF IF I-INT(I/7)*7=0 THEN G=G+I ELSEIF I-INT(I/17)*17=0 THEN H=H+I ELSEIF I-INT(I/27)*27=0 THEN J=J+I ELSEIF I-INT(I/37)*37=0 THEN K=K+I ELSE L=L+I ENDIF NEXT TEXT 100,110,"3",0,1,1,"(1) 1+2+3+...+100="+STR\$(A) TEXT 100,160,"3",0,1,1,"(2) 1+3+5+...+99="+STR\$(B) TEXT 100,210,"3",0,1,1,"(3) 2+4+6+...+100="+STR\$(C) TEXT 100,260,"3",0,1,1,"(4) 3+6+9+...+99="+STR\$(D) TEXT 100,310,"3",0,1,1,"(5) 5+10+15+...+100="+STR\$(E) TEXT 100,360,"3",0,1,1," (1)-(5)= "+STR\$(F) TEXT 100,410,"3",0,1,1,"(6) 7+14+21+...+98="+STR\$(G) TEXT 100,460,"3",0,1,1,"(7) 17+34+51+...+85=" +STR\$(H) TEXT 100,510,"3",0,1,1,"(8) 27+54+...+81="+STR\$(J) TEXT 100,560,"3",0,1,1,"(9) 37+74="+STR\$(K) TEXT 100,610,"3",0,1,1," (1)-(6)-(7)-(8)-(9)="+STR\$(L) PRINT 1,1 </pre> | <pre> (1) 1+2+3+...+100=5050 (2) 1+3+5+...+99=2500 (3) 2+4+6+...+100=2550 (4) 3+6+9+...+99=1683 (5) 5+10+15+...+100=1050 (1)-(5)=4000 (6) 7+14+21+...+98=735 (7) 17+34+51+...+85=255 (8) 27+54+...+81=162 (9) 37+74=111 (1)-(6)-(7)-(8)-(9)=3787 </pre> |

|  |  |
|--|--|
| EOP  |  |
| <pre> DOWNLOAD F, "TEST.BAS" SIZE 4,1 GAP 0,0 DIRECTION 1 CLS A=85 B=10 :START IF A&lt;100 THEN GOTO L1 ELSE GOTO L2 :L1 CLS TEXT 100,10,"3",0,1,1,STR\$(A) + " IS SMALLER THEN 100" PRINT 1 A=A+B GOTO START ENDIF :L2 CLS TEXT 100,10,"3",0,1,1,STR\$(A) + "IS LAGER THEN 100" PRINT 1 EOP TEST </pre> | <pre> 105 IS LAGER THEN 100  95 IS SMALLER THEN 100  85 IS SMALLER THEN 100 </pre> |

**Note:**

*If the result of the expression is nonzero, the statement following THEN will be executed. If the result of the expression is zero, and the statement following the ELSE is present, it will be executed. Otherwise the next line of statement is executed.*

*If there are block of statements in IF...THEN ...ELSE, ENDIF must be used at the end of the IF...THEN ...ELSE statement.*

**Limitations:**

*The total numbers of nested IF ...THEN ...ELSE statement in a program cannot exceed 40.*

*The total numbers of nested IF ...THEN ...ELSE, FOR...NEXT, GOSUB RETURN in a program cannot exceed 40 loops.*

**See Also**

DOWNLOAD, EOP

## ● GOSUB...RETURN

### Description

This command will branch to a subroutine, executing statements until "RETURN" is reached.

### Syntax

```
GOSUB LABEL  
    statement
```

```
END
```

```
:LABEL  
    statement
```

```
RETURN
```

| <u>Parameter</u> | <u>Description</u>  |
|------------------|---|
| LABEL            | Beginning of the subroutine. The maximum length of the label is 8 characters. |

### Example

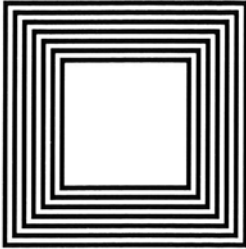
| <u>Sample code</u>  | <u>Result</u>  |
|---|--|
| <pre>DOWNLOAD "GOSUB1.BAS"<br/>SIZE 4,3<br/>GAP 0,0<br/>DIRECTION 1<br/>CLS<br/>TEXT 10,10,"3",0,1,1,"GOSUB &amp; RETURN COMMAND TEST"<br/>GOSUB DR_BOX<br/>PRINT 1<br/>END<br/>:DR_BOX<br/>FOR I=21 TO 81 STEP 10<br/>BOX 80+I,80+I,80+300-I,80+300-I,5<br/>NEXT<br/>RETURN<br/>EOP<br/>GOSUB1</pre> | <p>GOSUB &amp; RETURN COMMAND TEST</p>  |

### See Also

DOWNLOAD, EOP, END, GOTO

## ● GOTO

### Description

This command is used to branch to a specified label. The label cannot exceed 8 characters in length.

### Syntax

**GOTO LABEL**

**:LABEL**

| <u>Parameter</u> | <u>Description</u>   |
|------------------|--|
| LABEL            | Beginning of the point. The maximum length of the label is 8 characters. |

### Example

| <u>Sample code</u>   | <u>Result</u>                              |
|--|--|
| <pre>DOWNLOAD "GOTO1.BAS"<br/>SIZE 4,3<br/>GAP 0,0<br/>DIRECTION 1<br/>CLS<br/>A=0<br/>TOTAL=0<br/>:START<br/>IF A&lt;100 THEN<br/>GOTO SUM<br/>ELSE<br/>GOTO PRTOUT<br/>ENDIF<br/>:SUM<br/>A=A+1<br/>TOTAL=TOTAL+A<br/>GOTO START<br/>:PRTOUT<br/>B\$="THE SUMMATION OF 1..100 IS<br/>"+STR\$(TOTAL)<br/>TEXT 10,100, "3",0,1,1,B\$<br/>PRINT 1<br/>END<br/>EOP</pre> | <pre>THE SUMMATION OF 1..100 IS 5050</pre> |

### See Also

DOWNLOAD, EOP, END, GOSUB...RETURN

## ● INP\$ ( )

### Description

One byte is received from communication port.

### Syntax

INP\$(n)

| <u>Parameter</u> | <u>Description</u>       |
|------------------|--------------------------|
| N                | 1 : com1 port in printer |

### Example

#### Sample code

```
DOWNLOAD "TEST.BAS"  
  
T$=""  
FOR I=1 TO 5  
T$=T$+INP$(1)  
NEXT  
  
SIZE 4,0.5  
GAP 0,0  
CLS  
TEXT 10,10, "3",0,1,1, "The received data is: "+T$  
PRINT 1  
EOP  
TEST  
12345
```

#### Result

The received data is: 12345

### See Also

INP()

## ● INP( )

### Description

One byte (ASCII value) is received from communication port.

### Syntax

INP(n)

| <u>Parameter</u> | <u>Description</u>       |
|------------------|--------------------------|
| n                | 1 : com1 port in printer |

**Note:**  
*This command has been supported since V6.91 EZ and later firmware.*

### Example

|   |
|---|
| <p><b>Sample code</b></p> <pre>DOWNLOAD "TEST.BAS"  146sci=0 str\$=""  FOR I=1 TO 5 146sci=INP(1) str\$=str\$+" " +STR\$(146sci) OUT 146sci NEXT  SIZE 4,0.5 GAP 0,0 CLS TEXT 10,10, "3",0,1,1, "The received data is: "+str\$ PRINT 1 EOP TEST 12345</pre> |
| <p><b>Result</b></p> <p>The received data is: 49 50 51 52 53</p>  |

### See Also

INP\$( )

## ● LOB( )

### Description

This function returns the size of data in receiving buffer.

### Syntax

LOB ( )

#### Note:

*This command has been supported since V6.78 EZ and later firmware.*

### Example

#### Sample Code

```
DOWNLOAD "TEST.BAS"
```

```
DATA$=""
```

```
WHILE LOB(<>0
```

```
DATA$=DATA$+INP$(1)
```

```
WEND
```

```
SIZE 4,0.5
```

```
GAP 0,0
```

```
CLS
```

```
BOX 10,10,800,100,2
```

```
BLOCK 15,15,790,90, "0",0,8,8,DATA$
```

```
PRINT 1
```

```
EOP
```

```
TEST
```

```
We stand behind our products with one of the most comprehensive support programs in the Auto-ID industry.
```

#### Result

203 dpi:

```
We stand behind our products with one of the most comprehensive support programs in the Auto-ID industry.
```

300 dpi:

```
We stand behind our products with one of the most comprehensive support programs in the Auto-ID industry.
```

### See Also

INP\$( ), WHILE ... WEND



## ● INPUT

### Description

This command receives data through specific port. This command is used with portable keyboard KP-200.

### Syntax

**INPUT ["Prompt string", number of digits], variables**

The comma also can be replaced by semicolon, such as:

**INPUT ["Prompt string"; number of digits]; variables**

| <u>Parameter</u> | <u>Description</u>  |
|------------------|---|
| Prompt string    | The prompt string is shown on keyboard LCD screen. The maximum length of prompt string is 20 characters |
| Number of digits | Maximum number of characters is 255   |
| Variables        | The variable to receive input data  |

### Example

| <u>Sample code</u>   | <u>Result</u>  |
|--|--|
| <pre>DOWNLOAD "TEXT.BAS" SIZE 4,3 GAP 0,0 DIRECTION 1  :START INPUT "CODE 39 : ",C39\$ INPUT "EAN 13: ",12,E13\$ CLS TEXT 20,50, "3",0,1,1, "INPUT and KP-200 Test" BARCODE 20,100, "39",48,1,0,2,5,C39\$ BARCODE 20,200, "EAN13",48,1,0,4,4,E13\$ PRINT 1 GOTO START EOP TEXT 123456 123456789012</pre> | <pre>INPUT and KP-200 Test 123456 1234567890128</pre>  |

### See Also

DOWNLOAD, EOP, END, GOTO

## ● PREINPUT

### Description

This command can define the start character for command INPUT.

### Syntax

PREINPUT var\$  
PREINPUT CHR\$(n)

| <u>Parameter</u> | <u>Description</u>                                 |
|------------------|--|
| var\$            | The specific character or string in front of data. |
| N                | n = 1 ~ 255  |

**Note:**  
*This command has been supported since V6.81 EZ and later firmware.*

### Example

PREINPUT "<"  
PREINPUT CHR\$(2)

### See also

POSTINPUT, INPUT, SET FILTER

## ● POSTINPUT

### Description

This command can define the end character for command INPUT.

### Syntax

POSTINPUT var\$

POSTINPUT CHR\$(n)

| <u>Parameter</u> | <u>Description</u>                               |
|------------------|--|
| var\$            | The specific character or string in end of data. |
| N                | n = 1 ~ 255                                      |

**Note:**  
*This command has been supported since V6.81 EZ and later firmware.*

### Example

POSTINPUT ">"

POSTINPUT CHR\$(3)

### See also

PREINPUT, INPUT, SET FILTER

## ● SET FILTER ON/OFF

### Description

This command is using to enable/disable commands PREINPUT and POSTINPUT.

### Syntax

**SET FILTER ON/OFF**

| <u>Parameter</u> | <u>Description</u>             |
|------------------|--------------------------------|
| ON               | Enable PREINPUT and POSTINPUT  |
| OFF              | Disable PREINPUT and POSTINPUT |

**Note:**  
*This command has been supported since V6.81 EZ and later firmware.*

### Example

| <u>Sample Code</u>  | <u>Result</u>                                  |
|---|--|
| <pre>DOWNLOAD "TEST.BAS"  PREINPUT "&lt;=" POSTINPUT "=&gt;" SET FILTER ON  START: INPUT "DATA",data1\$ SIZE 4,0.25 GAP 0,0 DIRECTION 1 CLS TEXT 10,10, "3",0,1,1, "DATA = "+data1\$ PRINT 1 GOTO START EOP TEST &lt;=1234=&gt;&lt;=5678=&gt;&lt;=9012=&gt;</pre> | <pre>DATA = 9012 DATA = 5678 DATA = 1234</pre> |

### See also

PREINPUT, POSTINPUT, INPUT

## ● REM

### Description

Comment. Prefix is "REM", which will be ignored by the printer.

### Syntax

REM

### Example

#### Sample code

```
REM *****  
REM This is a demonstration program*  
REM *****  
DOWNLOAD "REMARK.BAS"  
SIZE 4,3  
GAP 0,0  
DIRECTION 1  
CLS  
TEXT 50,50, "3",0,1,1, "REMARK DEMO PROGRAM"  
REM TEXT 50,100, "3",0,1,1, "REMARK DEMO PROGRAM"  
PRINT 1,1  
EOP  
REMARK
```

#### Result

REMARK DEMO PROGRAM

### See Also

DOWNLOAD, EOP, END

## ● OUT

### Description

This command returns data through the specific port.

### Syntax

OUT [port] "prompt",variable

OUT [port] "prompt";variable

| Parameter    | Description  |
|--------------|--|
| port         | Optional. Specified the port for returning data/string. Default is returning the data/string from the port which is sending data to printer.<br><b>COM:</b> Returning data/string from COM port.<br><b>USB:</b> Returning data/string from USB port.<br><b>NET:</b> Returning data/string from LAN port. |
| Prompt       | Prompt string.   |
| Variable     | The output message.  |
| ,            | The "prompt" and "variable" are separated by <0x0D><0x0A>.   |
| ;            | The "variable" comes behind "prompt" directly.   |
| <b>Note:</b> | <b><i>This command has been supported since V6.93 EZ and later firmware.</i></b>   |

### Example

#### Sample Code

OUT USB "USB: "; "This is returning data from USB. "

OUT COM "COM"; "This is returning data from COM. "

OUT NET "NET: "; "This is returning data from LAN. "

#### Result

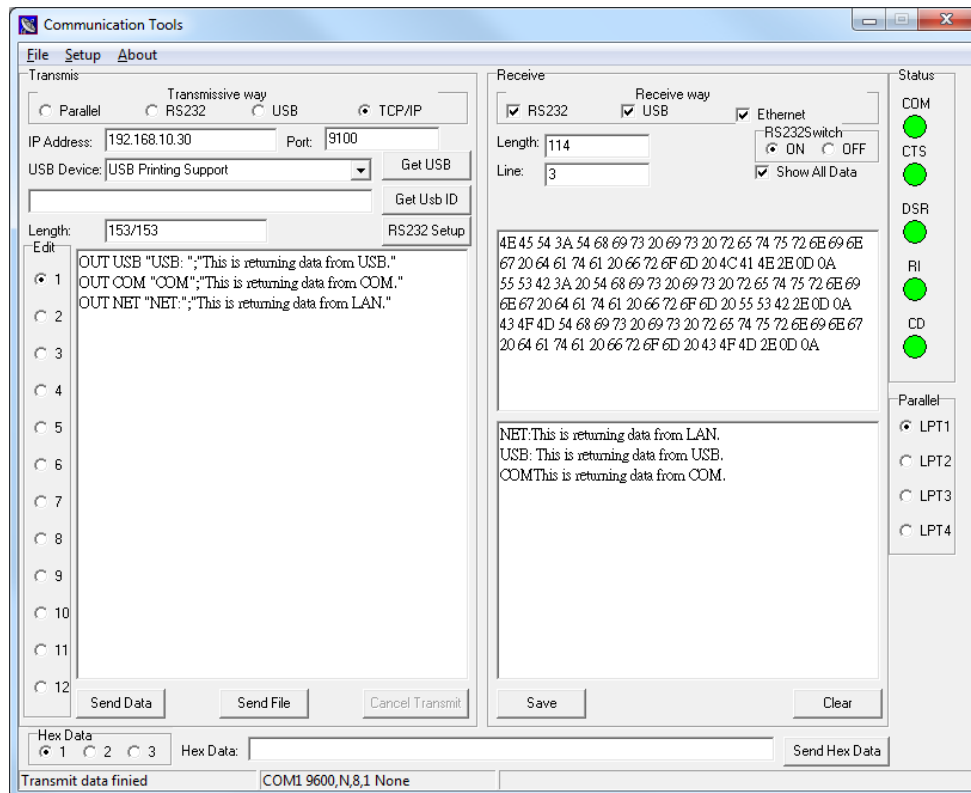

## ● OUTR

### Description

This command sends data through RS-232 port only.

### Syntax

OUTR "prompt",variable

OUTR "prompt";variable

| <u>Parameter</u> | <u>Description</u>   |
|------------------|--|
| prompt           | Prompt string.   |
| Variable         | The output message.  |
| ,                | The "prompt" and "variable" are separated by <0x0D><0x0A>. |
| ;                | The "variable" comes behinds "prompt" directly.            |

**Note:**  
*This command has been supported since V6.68 EZ and later firmware.*

### Example

#### Sample Code

OUTR "COM: ", " This is returning data from RS-232 only."

#### Result

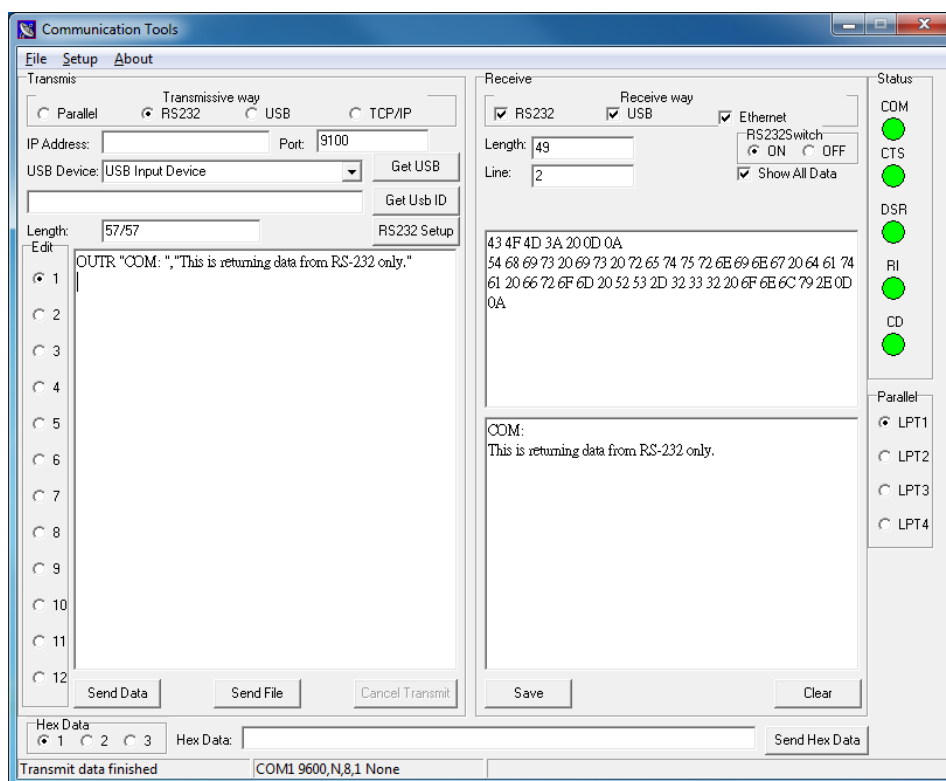

## ● GETKEY( )

### Description

This command is used to get the status of the PAUSE and FEED keys. This command waits until either key is pressed, whereupon 0 is returned if PAUSE key is pressed and 1 is returned if FEED key is pressed.

### Syntax

GETKEY()

| PAUSE | FEED |
|-------|------|
| 0     | 1    |

Note: Desktop printers do not have the PAUSE key except TTP-243/244 series printers.

### Example

#### Sample code

```
DOWNLOAD "DEMO4.BAS"  
SIZE 4,3  
GAP 0,0  
CLS  
:START  
A=GETKEY()  
IF A=0 THEN GOTO PAUSEB  
IF A=1 THEN GOTO FEEDB  
:PAUSEB  
CLS  
TEXT 50,10, "4",0,1,1, "PAUSE key is pressed !"  
PRINT 1  
GOTO START  
:FEEDB  
CLS  
TEXT 50,10, "4",0,1,1, "FEED key is pressed !"  
PRINT 1  
EOP
```

### See Also

DOWNLOAD, EOP, END, GOTO



## ● INT( )

### Description

This function truncates a floating point number.

### Syntax

INT (n)

| <u>Parameter</u> | <u>Description</u>   |
|------------------|--|
| n                | Positive or negative integer, floating point number or mathematical expression |

### Example

| <u>Sample code</u>  | <u>Result</u>            |
|---|--------------------------|
| <pre>DOWNLOAD "DEMO.BAS" SIZE 4,1 GAP 0,0 DIRECTION 1 INPUT "Number: ",Num CLS REM **** To round up or down**** N=INT(Num+0.5) IF N&gt;Num THEN TEXT 50,100, "3",0,1,1, "To round up= " +STR\$(N) ELSE TEXT 50,100, "3",0,1,1, "To round down= " +STR\$(N) ENDIF PRINT 1 EOP 56.2</pre> | <p>To round down= 56</p> |

### See Also

DOWNLOAD, EOP, END, ABS(), ASC(), STR\$( )

## ● LEFT\$( )

### Description

This function returns the specified number of characters down from the initial character of a string.

### Syntax

LEFT\$(X\$, n)

| <u>Parameter</u> | <u>Description</u>                      |
|------------------|---|
| X\$              | The string to be processed              |
| n                | The number of characters to be returned |

### Example

| <u>Sample code</u>  | <u>Result</u>  |
|---|--|
| <pre>DOWNLOAD "TEST.BAS" SIZE 4,1 GAP 0,0 DIRECTION 1 A\$="BARCODE PRINTER DEMO PRINTING" C\$=LEFT\$(A\$,10) CLS TEXT 10,10,"3",0,1,1,A\$ TEXT 10,100,"3",0,1,1, "10 LEFT 10 CHARS: " +C\$ PRINT 1 EOP TEST</pre> | <pre>BARCODE PRINTER DEMO PRINTING  10 LEFT 10 CHARS: BARCODE PR</pre> |

### See Also

DOWNLOAD, EOP, END, RIGHT\$(), MID\$(), LEN(), STR\$()

## ● LEN( )

### Description

This function returns the length of a string.

### Syntax

LEN (string)

| <u>Parameter</u> | <u>Description</u>                         |
|------------------|--|
| string           | The string whose length is to be measured. |

### Example

| <u>Sample Code</u>  | <u>Result</u>  |
|---|--|
| <pre>DOWNLOAD "DEMO.BAS" SIZE 4,1 GAP 0,0 DIRECTION 1 A\$="ABCDEFGHIJKLMNPOQRSTUVWXYZ" B=LEN(A\$) CLS TEXT 10,10, "3",0,1,1,A\$ TEXT 10,50, "3",0,1,1,"STRING LENGTH=" +STR\$(B) PRINT 1 EOP DEMO</pre> | <pre>ABCDEFGHIJKLMNPOQRSTUVWXYZ STRING LENGTH=26</pre> |

### See Also

DOWNLOAD, EOP, END, LEFT\$( ), LEN(), RIGHT\$( ), MID\$( ), STR\$( ), VAL()

## ● MID\$( )

### Description

This function retrieves the specified number of characters down from the *m*th character of a string.

### Syntax

MID\$(string,m,n)

| <u>Parameter</u> | <u>Description</u>   |
|------------------|--|
| string           | The string to be processed   |
| m                | The beginning of m <sup>th</sup> characters in the string<br>1 <= m <= string length |
| n                | The number of characters to return   |

### Example

| <u>Sample code</u>  | <u>Result</u>   |
|---|---|
| <pre>DOWNLOAD "DEMO.BAS" SIZE 4,1 GAP 0,0 DIRECTION 1 A\$="ABCDEFGHIJKLMNPOQRSTUVWXYZ" E\$=MID\$(A\$,11,10) CLS TEXT 10,10, "3",0,1,1,A\$ TEXT 10,200, "3",0,1,1,"10 MIDDLE CHARS: "+E\$ PRINT 1 EOP DEMO</pre> | <pre>ABCDEFGHIJKLMNPOQRSTUVWXYZ 10 MIDDLE CHARS: KLMNOPQRST</pre> |

### See Also

DOWNLOAD, EOP, END, LEFT\$( ), LEN( ), RIGHT\$( ), STR\$( ), VAL( )

## ● RIGHT\$( )

### Description

This function returns a specified number of characters up from the end of a string.

### Syntax

RIGHT\$(X\$,n)

| <u>Parameter</u> | <u>Description</u>  |
|------------------|---|
| X\$              | The string to be processed  |
| n                | The number of characters to be returned from the right side (end) of the string |

### Example

| <u>Sample code</u>   | <u>Result</u>  |
|--|--|
| <pre>DOWNLOAD "DEMO.BAS" SIZE 4,1 GAP 0,0 DIRECTION 1 A\$="ABCDEFGHIJKLMNPOQRSTUVWXYZ" D\$=RIGHT\$(A\$,10) CLS TEXT 10,10,"3",0,1,1,A\$ TEXT 10,150,"3",0,1,1, "10 RIGHT CHARS: "+D\$ PRINT 1 EOP DEMO</pre> | <pre>ABCDEFGHIJKLMNPOQRSTUVWXYZ 10 RIGHT CHARS: QRSTUVWXYZ</pre> |

### See Also

DOWNLOAD, EOP, END, LEFT\$( ), LEN(), MID\$( ), STR\$( ), VAL()

## ● STR\$( )

### Description

This function converts a specified value or expression into corresponding string of characters.

### Syntax

STR\$( n)

| <u>Parameter</u> | <u>Description</u>   |
|------------------|--|
| n                | An integer, floating point number or mathematical expression |

### Example

| <u>Sample code</u>   | <u>Result</u>  |
|--|--|
| <pre>DOWNLOAD "DEMO.BAS" SIZE 4,1 GAP 0,0 DIRECTION 1 A\$="ABCDEFGHJKLMNOPQRSTUVWXYZ" F=100 G=500 H\$=STR\$(F+G) CLS TEXT 10,10, "3",0,1,1,A\$ TEXT 10,60, "3",0,1,1, "F=" +STR\$(F) TEXT 10,110, "3",0,1,1, "G=" +STR\$(G) TEXT 10,160, "3",0,1,1, "F+G=" +H\$ PRINT 1 EOP DEMO</pre> | <pre>ABCDEFGHI JKLMNOPQRSTUVWXYZ F=100 G=500 F+G=600</pre> |

### See Also

DOWNLOAD, EOP, END, LEFT\$( ), LEN(), RIGHT\$( ), MID\$( ), VAL()

## ● STRCOMP( )

### Description

Returns -1, 0, or 1, based on the result of a string comparison.

### Syntax

**STRCOMP(str1\$,str2\$[,comp])**

| <u>Parameter</u> | <u>Description</u>   |
|------------------|--|
| str1\$           | Required. Any valid string expression.   |
| Str2\$           | Required. Any valid string expression.   |
| Comp             | Optional. Specifies the type of string comparison.<br>0: Binary comparison. Default.<br>1: Textual comparison. The comparison is <b>case-insensitive</b> . |

| Condition                    | Return value |
|------------------------------|--------------|
| str1\$ sorts ahead of str2\$ | -1           |
| str1\$ is equal to str2\$    | 0            |
| str1\$ sorts after str2\$    | 1            |

**Note:**  
*This command has been supported since V6.81 EZ and later firmware.*

### Example

#### Sample Code

```
DOWNLOAD "TEST.BAS"  
STR1$ = "ABCD"  
STR2$ = "abcd"  
  
result1 = STRCOMP(STR1$,STR2$)  
result2 = STRCOMP(STR1$,STR2$,1)  
result3 = STRCOMP(STR2$,STR1$)  
  
SIZE 4,1  
GAP 0,0  
DIRECTION 1  
CLS  
TEXT 100,10,"3",0,1,1,STR$(result1)+": \[" +STR1$+"\[" sorts ahead of \[" +STR2$+" \["  
TEXT 100,60,"3",0,1,1," " +STR$(result2)+": \[" +STR1$+"\[" is equal to \[" +STR2$+" \["  
TEXT 100,110,"3",0,1,1," " +STR$(result3)+": \[" +STR2$+"\[" sorts after \[" +STR1$+"\["  
PRINT 1  
EOP  
TEST
```

#### Result

```
-1: "ABCD" sorts ahead of "abcd"  
0: "ABCD" is equal to "abcd"  
1: "abcd" sorts after "ABCD"
```

### See Also

INSTR()

## ● INSTR ( )

### Description

Returns an integer specifying the start position of the first occurrence of one string within another.

### Syntax

INSTR ([start,]str1\$,str2\$)

| <u>Parameter</u> | <u>Description</u>   |
|------------------|--|
| start            | Optional. Numeric expression that sets the starting position for each search. If omitted, search begins at the first character position. The start index is 1 – based. |
| Str1\$           | Required. String expression being searched.  |
| Str2\$           | Required. String expression sought.  |

**Note:**  
*This command has been supported since V6.59 EZ and later firmware.*

### Example

#### Sample code

```
DOWNLOAD "DEMO.BAS"
string$="ABC123ABC123"
searchfor$="123"
starpos=8

temp1=INSTR(string$,searchfor$)
temp2=INSTR(starpos,string$,searchfor$)

str1$=searchfor$+"in "+string$+"is "+STR$(temp1)
str2$=searchfor$+"in "+string$+"after"+STR$(starpos)+ " is "+STR$(temp2)

SIZE 4,1
GAP 0,0
DIRECTION 1
CLS
TEXT 10,10, "3",0,1,1,str1$
TEXT 10,60, "3",0,1,1,str2$
PRINT 1
EOP
DEMO
```

#### Result

```
123 in ABC123ABC123 is 4
123 in ABC123ABC123 after 8 is 10
```

### See Also

STRCOMP()



## ● TRIM\$( )

### Description

Removes both leading and trailing blank spaces or specific characters from a string.

### Syntax

**TRIM\$(str\$,list\$)**

| <u>Parameter</u> | <u>Description</u>   |
|------------------|--|
| str\$            | The string that will be trimmed.                             |
| List\$           | Optional. The specific characters in list\$ will be removed. |

**Note:**  
*This command has been supported since V6.59 EZ and later firmware.*

### Example

| <b>Sample Code</b>   |  |
|--|--|
| <pre>DOWNLOAD "DEMO.BAS" data1\$="1234567" data2\$="a1234567a" data3\$="[&lt;12345&gt;]"  SIZE 4,1.5 GAP 0,0 DIRECTION 1 CLS TEXT 50,020,"3",0,1,1,"LTRIM\$(\" +data1\$+\" \")           = " +LTRIM\$(data1\$) TEXT 50,050,"3",0,1,1,"TRIM\$(\" +data1\$+\" \")           = " +TRIM\$(data1\$) TEXT 50,080,"3",0,1,1,"RTRIM\$(\" +data1\$+\" \")          = " +RTRIM\$(data1\$) TEXT 50,110,"3",0,1,1,"LTRIM\$(\" +data2\$+ \" \", \"a\")    = " +LTRIM\$(data2\$, "a") TEXT 50,140,"3",0,1,1,"TRIM\$(\" +data2\$+ \" \", \"a\")    = " +TRIM\$(data2\$, "a") TEXT 50,170,"3",0,1,1,"RTRIM\$(\" +data2\$+ \" \", \"a\")   = " +RTRIM\$(data2\$, "a") TEXT 50,200,"3",0,1,1,"LTRIM\$(\" +data3\$+ \" \", \"[&lt;&gt;]\") = " +LTRIM\$(data3\$, "[&lt;&gt;]") TEXT 50,230,"3",0,1,1,"TRIM\$(\" +data3\$+ \" \", \"[&lt;&gt;]\") = " +TRIM\$(data3\$, "[&lt;&gt;]") TEXT 50,260,"3",0,1,1,"RTRIM\$(\" +data3\$+ \" \", \"[&lt;&gt;]\") = " +RTRIM\$(data3\$, "[&lt;&gt;]") PRINT 1 EOP DEMO</pre> |  |
| <b>Result</b>  |  |
| <pre>LTRIM\$( " 1234567 ")           = 1234567 TRIM\$( " 1234567 ")           = 1234567 RTRIM\$( " 1234567 ")          = 1234567 LTRIM\$( "a1234567a", "a")     = 1234567a TRIM\$( "a1234567a", "a")     = 1234567 RTRIM\$( "a1234567a", "a")    = a1234567 LTRIM\$( "[&lt;12345&gt;", "[&lt;&gt;]")   = 12345&gt; TRIM\$( "[&lt;12345&gt;", "[&lt;&gt;]")   = 12345 RTRIM\$( "[&lt;12345&gt;", "[&lt;&gt;]")  = [&lt;12345</pre>  |  |

### See Also

LTRIM\$( ), RTRIM\$( )

## ● LTRIM\$( )

### Description

Removes leading blank space from a string.

### Syntax

LTRIM\$(str\$,list\$)

| <u>Parameter</u> | <u>Description</u>   |
|------------------|--|
| str\$            | The string that will be trimmed.                             |
| List\$           | Optional. The specific characters in list\$ will be removed. |

**Note:**  
*This command has been supported since V6.59 EZ and later firmware.*

### Example

| <u>Sample Code</u>  |                                |
|---|--------------------------------|
| DOWNLOAD "DEMO.BAS"   |                                |
| data1\$="1234567"   |                                |
| data2\$="a1234567a"   |                                |
| data3\$="[<12345>]"   |                                |
| SIZE 4,1.5  |                                |
| GAP 0,0   |                                |
| DIRECTION 1   |                                |
| CLS   |                                |
| TEXT 50,020,"3",0,1,1,"LTRIM\$(\"[\" +data1\$+\" \")                    | =\" +LTRIM\$(data1\$)          |
| TEXT 50,050,\"3\",0,1,1,\"TRIM\$(\"[\" +data1\$+\" \")                  | =\" +TRIM\$(data1\$)           |
| TEXT 50,080,\"3\",0,1,1,\"RTRIM\$(\"[\" +data1\$+\" \")                 | =\" +RTRIM\$(data1\$)          |
| TEXT 50,110,\"3\",0,1,1,\"LTRIM\$(\"[\" +data2\$+\" \",\"[\"a\")[\"]    | =\" +LTRIM\$(data2\$,\"a\")    |
| TEXT 50,140,\"3\",0,1,1,\"TRIM\$(\"[\" +data2\$+\" \",\"[\"a\")[\"]     | =\" +TRIM\$(data2\$,\"a\")     |
| TEXT 50,170,\"3\",0,1,1,\"RTRIM\$(\"[\" +data2\$+\" \",\"[\"a\")[\"]    | =\" +RTRIM\$(data2\$,\"a\")    |
| TEXT 50,200,\"3\",0,1,1,\"LTRIM\$(\"[\" +data3\$+\" \",\"[\"[<>]\")[\"] | =\" +LTRIM\$(data3\$,\"[<>]\") |
| TEXT 50,230,\"3\",0,1,1,\"TRIM\$(\"[\" +data3\$+\" \",\"[\"[<>]\")[\"]  | =\" +TRIM\$(data3\$,\"[<>]\")  |
| TEXT 50,260,\"3\",0,1,1,\"RTRIM\$(\"[\" +data3\$+\" \",\"[\"[<>]\")[\"] | =\" +RTRIM\$(data3\$,\"[<>]\") |
| PRINT 1   |                                |
| EOP   |                                |
| DEMO  |                                |

| <u>Result</u>                    |            |
|----------------------------------|------------|
| LTRIM\$(\" 1234567 \")           | = 1234567  |
| TRIM\$(\" 1234567 \")            | = 1234567  |
| RTRIM\$(\" 1234567 \")           | = 1234567  |
| LTRIM\$(\"a1234567a\", \"a\")    | = 1234567a |
| TRIM\$(\"a1234567a\", \"a\")     | = 1234567  |
| RTRIM\$(\"a1234567a\", \"a\")    | = a1234567 |
| LTRIM\$(\" [<12345>\", \"[<>]\") | = 12345>   |
| TRIM\$(\" [<12345>\", \"[<>]\")  | = 12345    |
| RTRIM\$(\" [<12345>\", \"[<>]\") | = [<12345  |

### See Also

TRIM\$( ), RTRIM\$( )

## ● RTRIM\$( )

### Description

Removes trailing blank space from a string.

### Syntax

RTRIM\$(str\$ [, list\$])

| <u>Parameter</u> | <u>Description</u>   |
|------------------|--|
| str\$            | The string that will be trimmed.                             |
| List\$           | Optional. The specific characters in list\$ will be removed. |

**Note:**  
*This command has been supported since V6.59 EZ and later firmware.*

### Example

| <u>Sample Code</u>   |   |
|--|---|
| <pre>DOWNLOAD "DEMO.BAS" data1\$="1234567" data2\$="a1234567a" data3\$="[&lt;12345&gt;]"  SIZE 4,1.5 GAP 0,0 DIRECTION 1 CLS TEXT 50,020,"3",0,1,1, "LTRIM\$(\"[\" +data1\$+\" \")           = " +LTRIM\$(data1\$) TEXT 50,050,"3",0,1,1, "TRIM\$(\"[\" +data1\$+\" \")           = " +TRIM\$(data1\$) TEXT 50,080,"3",0,1,1, "RTRIM\$(\"[\" +data1\$+\" \")          = " +RTRIM\$(data1\$) TEXT 50,110,"3",0,1,1, "LTRIM\$(\"[\" +data2\$+\" \", \")a\")    = " +LTRIM\$(data2\$, "a") TEXT 50,140,"3",0,1,1, "TRIM\$(\"[\" +data2\$+\" \", \")a\")    = " +TRIM\$(data2\$, "a") TEXT 50,170,"3",0,1,1, "RTRIM\$(\"[\" +data2\$+\" \", \")a\")   = " +RTRIM\$(data2\$, "a") TEXT 50,200,"3",0,1,1, "LTRIM\$(\"[\" +data3\$+\" \", \") [&lt; &gt; \") = " +LTRIM\$(data3\$, "[&lt;&gt;]") TEXT 50,230,"3",0,1,1, "TRIM\$(\"[\" +data3\$+\" \", \") [&lt; &gt; \") = " +TRIM\$(data3\$, "[&lt;&gt;]") TEXT 50,260,"3",0,1,1, "RTRIM\$(\"[\" +data3\$+\" \", \") [&lt; &gt; \") = " +RTRIM\$(data3\$, "[&lt;&gt;]") PRINT 1 EOP DEMO</pre> |   |
| <b>Result</b>  |   |
|  | <pre>LTRIM\$(" 1234567 ")           = 1234567 TRIM\$(" 1234567 ")           = 1234567 RTRIM\$(" 1234567 ")          = 1234567 LTRIM\$("a1234567a", "a")    = 1234567a TRIM\$("a1234567a", "a")    = 1234567 RTRIM\$("a1234567a", "a")   = a1234567 LTRIM\$("[&lt;12345&gt;]", "[&lt;&gt;]") = 12345&gt; TRIM\$("[&lt;12345&gt;]", "[&lt;&gt;]") = 12345 RTRIM\$("[&lt;12345&gt;]", "[&lt;&gt;]") = [&lt;12345</pre> |

### See Also

TRIM\$( ), LTRIM\$( )

## ● TEXTPIXEL( )

### Description

Returns the width of the text string in dot.

### Syntax

TEXTPIXEL (cont\$,font\$,size)

| <u>Parameter</u> | <u>Description</u>   |
|------------------|--|
| cont\$           | The content of text string.  |
| Font \$          | The font type. Please refer to the parameter <i>font</i> in command TEXT.      |
| Size             | The font size. Please refer to the parameter x-multiplication in command TEXT. |

**Note:**  
*This command has been supported since V6.61 EZ and later firmware.*

### Example

| <u>Sample code</u>  | <u>Result</u>   |
|---|---|
| <pre>DOWNLOAD "TEST.BAS"  str\$="ABCDEFGG" font\$="3" fontsize=3 strwidth=TEXTPIXEL(str\$,font\$,fontsize)  SIZE 4,1 GAP 0,0 DIRECTION 1 CLS TEXT 10,10,font\$,0,fontsize,fontsize,str\$ REVERSE 8,8,strwidth,72 PRINT 1 EOP TEST</pre> |  |

### See Also

TEXT, BARCODEPIXEL()

## ● BARCODEPIXEL( )

### Description

Returns the width of barcode in dot.

### Syntax

BARCODEPIXEL (cont\$, sym\$, narrow, wide)

| <u>Parameter</u> | <u>Description</u>   |
|------------------|--|
| cont\$           | The content of barcode.  |
| Sym \$           | Barcode type. Please refer to the parameter <b>code type</b> in command BARCODE.         |
| Narrow           | The width of narrow bar. Please refer to the parameter <b>narrow</b> in command BARCODE. |
| Wide             | The width of wide bar. Please refer to the parameter <b>wide</b> in command BARCODE.     |

**Note:**  
*This command has been supported since V6.72 EZ and later firmware.*

### Example

| <u>Sample code</u>  | <u>Result</u>   |
|---|---|
| <pre>DOWNLOAD "TEST.BAS"  cont\$="ABCDEFGG" sym\$="39" narrow=2 wide=6 codewidth=BARCODEPIXEL(cont\$,sym\$,narrow,wide)  SIZE 4,1.5 GAP 0,0 DIRECTION 1 CLS BARCODE 10,10,sym\$,100,1,0,narrow,wide,cont\$ REVERSE 8,8,codewidth+8,132 BARCODE 10,160,sym\$,100,1,0,narrow,wide,cont\$ PRINT 1 EOP TEST</pre> |  |

### See Also

BARCODE, TEXTPIXEL()

## ● VAL( )

### Description

This function converts numeric characters into corresponding integer or floating point number.

### Syntax

VAL ("numeric character")

| <u>Parameter</u>  | <u>Description</u> |
|-------------------|--------------------|
| numeric character | " 0~9","."         |

### Example

| <u>Sample code</u>  | <u>Result</u>   |
|---|---|
| <pre>DOWNLOAD "DEMO.BAS" SIZE 4,1 GAP 0,0 DIRECTION 1 A\$="ABCDEFGHIJKLMNPOQRSTUVWXYZ" F\$="100" G\$="500" CLS H=VAL(F\$)+VAL(G\$) I\$=STR\$(H) TEXT 10,10, "3",0,1,1,A\$ TEXT 10,60, "3",0,1,1, "F=" +F\$ TEXT 10,110, "3",0,1,1, "G=" +G\$ TEXT 10,160, "3",0,1,1, "F+G=" +I\$ PRINT 1 EOP DEMO</pre> | <pre>ABCDEFGHIJKLMNPOQRSTUVWXYZ F=100 G=500 F+G=600</pre> |

### See Also

DOWNLOAD, EOP, END, LEFT\$( ), LEN( ), RIGHT\$( ), MID\$( ), STR\$( )

## ● BEEP

### Description

This command issues a beep sound on portable keyboard. Printer sends the string 0x07 to KP-200 portable keyboard.

### Syntax

**BEEP**

### Example

#### Sample code

```
DOWNLOAD "DEMO.BAS"  
SIZE 4,4  
GAP 0,0  
DIRECTION 1  
BEEP  
INPUT "Text1 =",TEXT1$  
CLS  
TEXT 100,100, "3",0,1,1,TEXT1$  
PRINT 1  
EOP
```

## ● NOW\$( )

### Description

Returns the current date and time according to the setting of your printer. The returned value always uses with commands FORMAT\$( ).

### Syntax

NOW\$( )

**Note:**

*This command has been supported since V6.81 EZ and later firmware.*

### Example

|  |
|--|
| <b>Sample code</b>   |
| <pre>SIZE 4,1 GAP 0,0 DIRECTION 1 CLS TEXT 10,10, "3",0,1,1, "Now is " +NOW\$( ) TEXT 10,60, "3",0,1,1,FORMAT\$(NOW\$(),"Long Date") PRINT 1</pre> |
| <b>Result</b>  |
| <pre>Now is 1/9/2013 2:19:27 PM Tuesday, January 09 2013</pre>   |

### See Also

FORMAT\$( )



## ● NOW

### Description

Returns the total days since A.D. 1900. This global variable always uses with commands `FORMAT$()` and `DATEADD()`.

### Syntax

`NOW`

*Note:*

*This command has been supported since V6.87 EZ and later firmware.*

### Example

#### Sample Code

```
SIZE 4,1
GAP 0,0
DIRECTION 1
CLS
TEXT 10,10, "3",0,1,1, "Total days since a.d. 1900: " +STR$(NOW)+ " days"
TEXT 10,50, "3",0,1,1, "Date Info in RTC: " +FORMAT$(NOW, "General Date")
TEXT 10,90, "3",0,1,1, "Date after a year: " +FORMAT$(DATEADD("yyyy",1,NOW), "General Date")
PRINT 1
```

#### Result

```
Total days since a.d. 1900: 41283.597176 days
Date Info in RTC: 1/9/2013 2:19:56 PM
Date after a year: 1/9/2014 2:19:56 PM
```

### See Also

`FORMAT$()`, `DATEADD()`, `NOW`

## ● FORMAT\$( )

### Description

Returns the current date, time, number and number value according to the setting of your printer.

### Syntax

**FORMAT\$(expression[,style\$])**

| <u>Parameter</u> | <u>Description</u>  |
|------------------|---|
| expression       | Required. Any valid expression.                                   |
| Style\$          | Optional. A valid named or user-defined format string expression. |

| <b>Predefined date/time formats</b> | <b>Description</b>   |
|-------------------------------------|--|
| General Date                        | Shows date and time.   |
| Long Date                           | Uses the Long Date format.   |
| Medium Date                         | Uses the dd-mmm-yy format.   |
| Short Date                          | Uses the Short Date format.  |
| Long Time                           | Shows the hour, minute, second, and "AM" or "PM" using the h:mm:ss format. |
| Medium Time                         | Shows the hour, minute, and "AM" or "PM" using the "hh:mm AM/PM" format.   |
| Short Time                          | Shows the hour and minute using the hh:mm format.                          |

| <b>User-defined date/time formats</b> | <b>Description</b>   |
|---------------------------------------|--|
| c                                     | Display the date as dddd and display the time as tttt, in that order.  |
| d                                     | Display the day as a number without a leading zero (1 – 31).   |
| dd                                    | Display the day as a number with a leading zero (01 – 31).   |
| ddd                                   | Display the day as an abbreviation (Sun – Sat).  |
| dddd                                  | Display the day as a full name (Sunday – Saturday).  |
| dddddd                                | Display a date serial number as a complete date (including day, month, and year), formatted according to your system's short date format setting. The default short date format is m/d/yyyy.       |
| dddddd                                | Display the date as a complete date (including day, month, and year), formatted according to the long date setting recognized by your system. The default long date format is dddd, mmmm dd, yyyy. |
| w                                     | Display the day of the week as a number (1 for Sunday through 7 for Saturday).   |
| ww                                    | Display the week of the year as a number (1 – 53).   |
| m                                     | Display the month as a number without a leading zero (1 – 12). If m immediately follows h or hh, the minute rather than the month is displayed.  |
| mm                                    | Display the month as a number with a leading zero (01 – 12). If mm immediately follows h or hh, the minute rather than the month is displayed.   |
| mmm                                   | Display the month as an abbreviation (Jan – Dec).  |
| mmmm                                  | Display the month as a full month name (January – December).   |
| q                                     | Display the quarter of the year as a number (1 – 4).   |
| y                                     | Display the day of the year as a number (1 – 366).   |
| yy                                    | Display the year as a 2-digit number (00 – 99).  |
| yyyy                                  | Display the year as a 4-digit number (100 – 9999).   |
| h                                     | Display the hour as a number without leading zeros (0 – 23).   |
| hh                                    | Display the hour as a number with leading zeros (00 – 23).   |
| n                                     | Display the minute as a number without leading zeros (0 – 59).   |
| nn                                    | Display the minute as a number with leading zeros (00 – 59).   |
| s                                     | Display the second as a number without leading zeros (0 – 59).   |
| ss                                    | Display the second as a number with leading zeros (00 – 59).   |
| tttt                                  | Display a time as a complete time (including hour, minute, and second). The default time format is h:mm:ss AM/PM.  |
| AM/PM                                 | Display an uppercase AM with any hour before noon; display an uppercase PM with any hour between noon and 11:59 P.M.   |
| am/pm                                 | Display a lowercase AM with any hour before noon; display a lowercase PM with any hour between noon and 11:59 P.M.   |

|          |  |
|----------|--|
| A/P      | Display an uppercase A with any hour before noon; display an uppercase P with any hour between noon and 11:59 P.M.                     |
| a/p      | Display a lowercase A with any hour before noon; display a lowercase P with any hour between noon and 11:59 P.M.                       |
| AMPM     | AMPM can be either uppercase or lowercase, but the case of the string displayed matches the string as defined by your system settings. |
| \        | Display the next character in the format string.   |
| "string" | Display the string inside the double quotation marks.  |

| Number formats (since A1.97) | Description  |
|------------------------------|--|
| General Number               | Displays the number as entered, with no rounding and no commas.  |
| Currency                     | Displays the number with a dollar sign, comma (if appropriate), and two digits to the right of the decimal point. Shows negative numbers inside parentheses. |
| Fixed                        | Displays the number with at least one digit to the left of the decimal separator and two digits to the right. Does not show comma.                           |
| Standard                     | Displays the number with at least one digit to the left of the decimal separator and two digits to the right and commas (if appropriate).                    |
| Percent                      | Multiplies the value by 100 and displays the result with two digits to the right of the decimal point and a percent sign at the end.                         |
| Scientific                   | Uses standard scientific notation.   |
| Yes/No                       | Any nonzero numeric value is Yes. Zero is No.  |
| True/False                   | Any nonzero numeric value is True. Zero is False.  |
| On/Off                       | Any nonzero numeric value is On. Zero is Off.  |

| User-defined number formats (since A1.97) | Description  |
|---|--|
| 0   | Digit placeholder. Displays a digit or a zero.         |
| #   | Digit placeholder. Displays a digit or nothing.        |
| .   | Decimal placeholder.                                   |
| %   | Percent placeholder. Multiplies the expression by 100. |
| ,   | Thousand separator.                                    |
| E- E+ e- e+                               | Scientific format.                                     |
| \   | Display the next character in the format string.       |
| "ABC"                                     | Display the string inside the double quotation marks.  |

| Different formats for different number values (since A1.97) | Description  |
|---|--|
| One section only  | The format expression applies to all values.   |
| Two section   | The first section applies to positive values and zeros; the second applies to negative values.                       |
| Three sections  | The first section applies to positive values, the second applies to negative values, and the third applies to zeros. |

**Note:**

***This command has been supported since V6.81 EZ and later firmware.***

**See Also**

NOW\$( ), DATEADD( ), NOW

## Example

| Sample Code  | Result   |
|--|--|
| <pre> SIZE 800 dot,1900 dot GAP 0,0 DIRECTION 1 CLS TEXT 15,10, "3",0,1,1, "General Date: "+FORMAT\$(NOW,"General Date") TEXT 15,60, "3",0,1,1, "Long Date: "+FORMAT\$(NOW,"Long Date") TEXT 15,110, "3",0,1,1, "Medium Date: "+FORMAT\$(NOW,"Medium Date") TEXT 15,160, "3",0,1,1, "Short Date: "+FORMAT\$(NOW,"Short Date") TEXT 15,210, "3",0,1,1, "Long Time: "+FORMAT\$(NOW,"Long Time") TEXT 15,260, "3",0,1,1, "Medium Time: "+FORMAT\$(NOW,"Medium Time") TEXT 15,310, "3",0,1,1, "Short Time: "+FORMAT\$(NOW,"Short Time") TEXT 15,360, "3",0,1,1, "c: "+FORMAT\$(NOW,"c") TEXT 15,410, "3",0,1,1, "d: "+FORMAT\$(NOW,"d") TEXT 15,460, "3",0,1,1, "dd: "+FORMAT\$(NOW,"dd") TEXT 15,510, "3",0,1,1, "ddd: "+FORMAT\$(NOW,"ddd") TEXT 15,560, "3",0,1,1, "dddd: "+FORMAT\$(NOW,"dddd") TEXT 15,610, "3",0,1,1, "dddd: "+FORMAT\$(NOW,"dddd") TEXT 15,660, "3",0,1,1, "dddddd: "+FORMAT\$(NOW,"dddddd") TEXT 15,710, "3",0,1,1, "w: "+FORMAT\$(NOW,"w") TEXT 15,760, "3",0,1,1, "ww: "+FORMAT\$(NOW,"ww") TEXT 15,810, "3",0,1,1, "m: "+FORMAT\$(NOW,"m") TEXT 15,860, "3",0,1,1, "mm: "+FORMAT\$(NOW,"mm") TEXT 15,910, "3",0,1,1, "mmm: "+FORMAT\$(NOW,"mmm") TEXT 15,960, "3",0,1,1, "mmmm: "+FORMAT\$(NOW,"mmmm") TEXT 15,1010, "3",0,1,1, "q: "+FORMAT\$(NOW,"q") TEXT 15,1060, "3",0,1,1, "y: "+FORMAT\$(NOW,"y") TEXT 15,1110, "3",0,1,1, "yy: "+FORMAT\$(NOW,"yy") TEXT 15,1160, "3",0,1,1, "yyyy: "+FORMAT\$(NOW,"yyyy") TEXT 15,1210, "3",0,1,1, "h: "+FORMAT\$(NOW,"h") TEXT 15,1260, "3",0,1,1, "hh: "+FORMAT\$(NOW,"hh") TEXT 15,1310, "3",0,1,1, "n: "+FORMAT\$(NOW,"n") TEXT 15,1360, "3",0,1,1, "nn: "+FORMAT\$(NOW,"nn") TEXT 15,1410, "3",0,1,1, "s: "+FORMAT\$(NOW,"s") TEXT 15,1460, "3",0,1,1, "ss: "+FORMAT\$(NOW,"ss") TEXT 15,1510, "3",0,1,1, "tttt: "+FORMAT\$(NOW,"tttt") TEXT 15,1560, "3",0,1,1, "AM/PM: "+FORMAT\$(NOW,"AM/PM") TEXT 15,1610, "3",0,1,1, "am/pm: "+FORMAT\$(NOW,"am/pm") TEXT 15,1660, "3",0,1,1, "A/P: "+FORMAT\$(NOW,"A/P") TEXT 15,1710, "3",0,1,1, "a/p: "+FORMAT\$(NOW,"a/p") TEXT 15,1760, "3",0,1,1, "AMPM: "+FORMAT\$(NOW,"AMPM") TEXT 15,1810, "3",0,1,1, "\" +FORMAT\$(NOW,"To\da\y i\s dddd") TEXT 15,1860, "3",0,1,1, "string: "+FORMAT\$(NOW,"To\da\y i\s dddd") PRINT 1 </pre> | <pre> General Date:1/9/2013 2:46:18 PM Long Date:Tuesday, January 09 2013 Medium Date:09-Jan-13 Short Date:1/9/2013 Long Time:2:46:18 PM Medium Time:02:46 PM Short Time:14:46 c:1/9/2013 2:46:18 PM d:9 dd:09 ddd:Tue dddd:Tuesday dddddd:1/9/2013 dddddd:Tuesday, January 09 2013 w:3 ww:2 m:1 mm:01 mmm:Jan mmmm:January q:1 y:9 yy:13 yyyy:2013 h:14 hh:14 n:46 nn:46 s:18 ss:18 tttt:2:46:18 PM AM/PM:PM am/pm:pm A/P:P a/p:p AMPM:PM \:Today is 1/9/2013 string:Today is 1/9/2013 </pre> |

| Sample Code (Since A1.97)   | Result  |
|---|---|
| <pre> SIZE 800 dot,850 dot GAP 0,0 DIRECTION 1 CLS TEXT 15,10, "3",0,1,1, "General Number: "+FORMAT\$(1234.5,"General Number") TEXT 15,60, "3",0,1,1, "Currency: "+FORMAT\$(1234.5,"Currency") TEXT 15,110, "3",0,1,1, "Fixed: "+FORMAT\$(1234.5,"Fixed") TEXT 15,160, "3",0,1,1, "Standard: "+FORMAT\$(1234.5,"Standard") TEXT 15,210, "3",0,1,1, "Percent: "+FORMAT\$(1234.5,"Percent") TEXT 15,260, "3",0,1,1, "Scientific: "+FORMAT\$(1234.5,"Scientific") TEXT 15,310, "3",0,1,1, "Yes/No: "+FORMAT\$(1234.5,"Yes/No") TEXT 15,360, "3",0,1,1, "Yes/No: "+FORMAT\$(0,"Yes/No") TEXT 15,410, "3",0,1,1, "True/False: "+FORMAT\$(0,"True/False") TEXT 15,460, "3",0,1,1, "On/Off: "+FORMAT\$(0,"On/Off") TEXT 15,510, "3",0,1,1, "00000.00: "+FORMAT\$(1234.5,"00000.00") TEXT 15,560, "3",0,1,1, "#####.##: "+FORMAT\$(1234.5,"#####.##") TEXT 15,610, "3",0,1,1, "##,##0.00: "+FORMAT\$(1234.5,"##,##0.00") TEXT 15,660, "3",0,1,1, "\$##0.00: "+FORMAT\$(1234.5,"\$##0.00") TEXT 15,710, "3",0,1,1, "\$0.00%: "+FORMAT\$(1234.5,"0.00%") TEXT 15,760, "3",0,1,1, "Yes/No: "+FORMAT\$(-12.3,"Yes/No") TEXT 15,810, "3",0,1,1, "0.00;(0.00): "+FORMAT\$(-12.3,"0.00;(0.00)") PRINT 1 </pre> | <pre> General Number: 1234.5 Currency: \$1,234.50 Fixed: 1234.50 Standard: 1,234.50 Percent: 123450.00% Scientific: 1.23E+03 Yes/No: Yes Yes/No: No True/False: False On/Off: Off 00000.00: 01234.50 #####.##: 1234.5 ##,##0.00: 1,234.50 \$##0.00: \$1234.50 \$0.00%: 123450.00% Yes/No: Yes 0.00;(0.00): (12.30) </pre> |

## ● DATEADD()

### Description

Returns a date after which a specified time/date interval has been added. The returned value always uses with commands FORMAT\$().

### Syntax

DATEADD(interval\$,number,date)

| <u>Parameter</u> | <u>Description</u>  |            |   |        |       |     |          |     |        |     |              |     |      |     |          |      |               |     |       |     |         |     |         |
|------------------|---|------------|---|--------|-------|-----|----------|-----|--------|-----|--------------|-----|------|-----|----------|------|---------------|-----|-------|-----|---------|-----|---------|
| interval\$,      | The time/date interval for adding. It can be one of following values. <table border="1" data-bbox="555 533 1121 898"> <thead> <tr> <th>Interval\$</th> <th>The interval unit of parameter interval\$</th> </tr> </thead> <tbody> <tr> <td>"yyyy"</td> <td>Year.</td> </tr> <tr> <td>"q"</td> <td>Quarter.</td> </tr> <tr> <td>"m"</td> <td>Month.</td> </tr> <tr> <td>"y"</td> <td>Day of year.</td> </tr> <tr> <td>"d"</td> <td>Day.</td> </tr> <tr> <td>"w"</td> <td>Weekday.</td> </tr> <tr> <td>"ww"</td> <td>Week of year.</td> </tr> <tr> <td>"h"</td> <td>Hour.</td> </tr> <tr> <td>"n"</td> <td>Minute.</td> </tr> <tr> <td>"s"</td> <td>Second.</td> </tr> </tbody> </table> | Interval\$ | The interval unit of parameter interval\$ | "yyyy" | Year. | "q" | Quarter. | "m" | Month. | "y" | Day of year. | "d" | Day. | "w" | Weekday. | "ww" | Week of year. | "h" | Hour. | "n" | Minute. | "s" | Second. |
| Interval\$       | The interval unit of parameter interval\$   |            |   |        |       |     |          |     |        |     |              |     |      |     |          |      |               |     |       |     |         |     |         |
| "yyyy"           | Year.   |            |   |        |       |     |          |     |        |     |              |     |      |     |          |      |               |     |       |     |         |     |         |
| "q"              | Quarter.  |            |   |        |       |     |          |     |        |     |              |     |      |     |          |      |               |     |       |     |         |     |         |
| "m"              | Month.  |            |   |        |       |     |          |     |        |     |              |     |      |     |          |      |               |     |       |     |         |     |         |
| "y"              | Day of year.  |            |   |        |       |     |          |     |        |     |              |     |      |     |          |      |               |     |       |     |         |     |         |
| "d"              | Day.  |            |   |        |       |     |          |     |        |     |              |     |      |     |          |      |               |     |       |     |         |     |         |
| "w"              | Weekday.  |            |   |        |       |     |          |     |        |     |              |     |      |     |          |      |               |     |       |     |         |     |         |
| "ww"             | Week of year.   |            |   |        |       |     |          |     |        |     |              |     |      |     |          |      |               |     |       |     |         |     |         |
| "h"              | Hour.   |            |   |        |       |     |          |     |        |     |              |     |      |     |          |      |               |     |       |     |         |     |         |
| "n"              | Minute.   |            |   |        |       |     |          |     |        |     |              |     |      |     |          |      |               |     |       |     |         |     |         |
| "s"              | Second.   |            |   |        |       |     |          |     |        |     |              |     |      |     |          |      |               |     |       |     |         |     |         |
| Number           | The number of interval\$ for adding.  |            |   |        |       |     |          |     |        |     |              |     |      |     |          |      |               |     |       |     |         |     |         |
| Date             | The date which is used to add the interval\$.<br>Date format: "yyyy/mm/dd"<br>Time format: "hh:nn:ss"   |            |   |        |       |     |          |     |        |     |              |     |      |     |          |      |               |     |       |     |         |     |         |
| <b>Note:</b>     | <b><i>This command has been supported since V6.87 EZ and later firmware.</i></b>  |            |   |        |       |     |          |     |        |     |              |     |      |     |          |      |               |     |       |     |         |     |         |

### Example

| <u>Sample Code 1</u>  | <u>Result 1</u>   |
|---|---|
| <pre> SIZE 4,2 GAP 0,0 DIRECTION 1 CLS TEXT 10,10, "3",0,1,1, "Current RTC info: " +NOW\$() TEXT 10,60, "3",0,1,1, "-1 year: " +FORMAT\$(DATEADD("yyyy",-1, " 11/26/2012 10:08:00"), "yyyy/mm/dd hh:nn:ss") TEXT 10,110, "3",0,1,1, "+9 months: " +FORMAT\$(DATEADD("m",9,NOW), "Short Date") TEXT 10,160, "3",0,1,1, "-8 hours: " +FORMAT\$(DATEADD("h",-8,NOW), "Short Time") TEXT 10,210, "3",0,1,1, "+5 mins: " +FORMAT\$(DATEADD("n",5,NOW), "Short Time") TEXT 10,260, "3",0,1,1, "+00 day: " +FORMAT\$(NOW, "Short Date") TEXT 10,310, "3",0,1,1, "+20 days: " +FORMAT\$(DATEADD("d",20,NOW), "Short Date") TEXT 10,360, "3",0,1,1, "-20 day: " +FORMAT\$(DATEADD("d",-20,NOW), "Short Date") PRINT 1           </pre> | <pre> Current RTC info: 1/9/2013 3:20:06 PM -1 year: 2011/11/26 10:08:00 +9 months: 10/9/2013 -8 hours: 07:20 +5 mins: 15:25 +00 day: 1/9/2013 +20 days: 1/29/2013 -20 day: 12/20/2012           </pre> |

## Sample Code 2

```
SIZE 4,2
GAP 0,0
DIRECTION 1
CLS
TEXT 10,60,"3",0,1,1,"-1 year: "+FORMAT$(DATEADD("yyyy",-1,"11/26/2012 10:08"),"yyyy/mm/dd hh:nn AM/PM")
TEXT 10,110,"3",0,1,1,"+9 months: "+FORMAT$(DATEADD("m",9,"11/26/2012 10:08"),"yyyy/mm/dd hh:nn AM/PM")
TEXT 10,160,"3",0,1,1,"+8 hours: "+FORMAT$(DATEADD("h",+8,"11/26/2012 10:08"),"yyyy/mm/dd hh:nn AM/PM")
TEXT 10,210,"3",0,1,1,"+00 day: "+FORMAT$("11/26/2012 10:08:00","yyyy/mm/dd hh:nn AM/PM")
TEXT 10,260,"3",0,1,1,"+20 days: "+FORMAT$(DATEADD("d",20,"11/26/2012 10:08"),"yyyy/mm/dd hh:nn AM/PM")
TEXT 10,310,"3",0,1,1,"-20 days: "+FORMAT$(DATEADD("d",-20,"11/26/2012 10:08"),"yyyy/mm/dd hh:nn AM/PM")
PRINT 1
```

## Result 2

```
-1 year: 2011/11/26 10:08 AM
+9 months: 2013/08/26 10:08 AM
+8 hours: 2012/11/26 06:08 PM
+00 day: 2012/11/26 10:08 AM
+20 days: 2012/12/16 10:08 AM
-20 days: 2012/11/06 10:08 AM
```

## ● FSEARCH()

### Description

This function returns the position of a string.

### Syntax

**FSEARCH(file handle, STR\$)**

| <u>Parameter</u> | <u>Description</u>                     |
|------------------|--|
| file handle      | 0 or 1                                 |
| STR\$            | Required. Any valid string expression. |

**Note:**  
*This command has been supported since A1.88 EZ and later firmware.*

### Example

| <u>Sample Code</u>   | <u>Result</u>  |
|--|--|
| <pre>DOWNLOAD "DATA1",10,1234567890 DOWNLOAD "DATA2",15,ABCDEFGHIJKLMNO DOWNLOAD "Test.BAS" SIZE 4,1.5 GAP 0,0 DIRECTION 1 CLS OPEN "DATA1",0 OPEN "DATA2",1 TEXT 10,90,"4",0,1,1,"FSEARCH() FUNCTION TEST" A=FSEARCH(0,"8") B=FSEARCH(1,"J") TEXT 10,140,"3",0,1,1,"8 position is:"+STR\$(A) TEXT 10,180,"3",0,1,1,"J position is:"+STR\$(B) PRINT 1 EOP Test</pre> | <pre>FSEARCH() FUNCTION TEST 8 position is: 7 J position is: 9</pre> |



## ● TOUCHPRESS()

### Description

This command is used to detect the status of touch screen. Returns 1 if the touch screen for the specified region is pressed, otherwise returns 0.

### Syntax

**TOUCHPRESS (left, top, right, bottom)**

| <u>Parameter</u> | <u>Description</u>                     |
|------------------|--|
| left             | Left side position of region (pixel)   |
| top              | Top side position of region (pixel)    |
| right            | Right side position of region (pixel)  |
| bottom           | Bottom side position of region (pixel) |

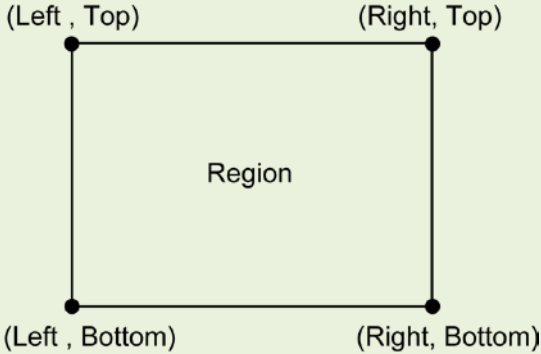
**Note:**

- This command has been supported since A1.76 EZ and later firmware
- This command only can be performed on the printer with touch screen. 272(W) x 480(H) pixels for MT & MX series

### Example

#### Sample Code

```
DOWNLOAD "DEMO.BAS"  
:START  
IF TOUCHPRESS(0,90,272,120) <> 0 THEN GOTO A  
GOTO START  
ENDIF  
:A  
CLS  
SIZE 4,1  
GAP 0,0  
DIRECTION 1  
TEXT 30,30,"3",0,1,1,"TOUCH TEST!!"  
PRINT 1,1  
EOP  
DEMO
```

## ● RECORDSET\$ ( )

### Description

This function returns a value from a table. Table is represented in a grid format, tabular form in rows and columns. Please refer to following table format on example.

### Syntax

**RECORDSET\$(TABLE\$, ROW, COLUMN [, DELIMITER])**

| <u>Parameter</u> | <u>Description</u>   |
|------------------|--|
| TABLE\$          | Table name   |
| ROW              | Number of row  |
| COLUMN           | Number (or name) of column                                     |
| DELIMITER        | Optional. Set the delimiter of table. The default is 09H <Tab> |

**Note: The Row is always a number. But the column can be a number or name**

### Example

| <u>Sample Code 1:</u>  | <u>Result</u>   |                |        |        |  |  |                |      |     |        |        |       |      |    |     |    |       |      |    |     |    |       |      |    |     |    |
|--|---|----------------|--------|--------|--|--|----------------|------|-----|--------|--------|-------|------|----|-----|----|-------|------|----|-----|----|-------|------|----|-----|----|
| <pre> DOWNLOAD F,"TEST.CSV",75,3 Name,Age,Height,Weight John,18,180,80 Mary,30,150,50 Mark,65,170,65  DOWNLOAD F,"TEST.BAS" CLOSE 0 SIZE 4,2 GAP 0,0 DIRECTION 1 CLS TEXT 100,50,"3",0,1,1,"Row 1 and Column 1 = " + RECORDSET\$("TEST.CSV", 1, 1, ASC(", ")) TEXT 100,100,"3",0,1,1,"Row 2 and Column 1 = " + RECORDSET\$("TEST.CSV", 2, 1, ASC(", ")) TEXT 100,150,"3",0,1,1,"John Age = " + RECORDSET\$("TEST.CSV", 1, 2, ASC(", ")) TEXT 100,200,"3",0,1,1,"Mary Age = " + RECORDSET\$("TEST.CSV", 2, 2, ASC(", ")) TEXT 100,250,"3",0,1,1,"John Height = " + RECORDSET\$("TEST.CSV",1,"Height", ASC(", ")) TEXT 100,300,"3",0,1,1,"Mary Height = " + RECORDSET\$("TEST.CSV",2,"Height", ASC(", ")) PRINT 1  EOP TEST         </pre> | <p>Row 1 and Column 1 = John<br/> Row 2 and Column 1 = Mary<br/> John Age = 18<br/> Mary Age = 30<br/> John Height = 180<br/> Mary Height = 150</p> <p><b>Table format (TEST.CSV)</b></p> <table border="1"> <tr> <td>Number of rows</td> <td colspan="4">3</td> </tr> <tr> <td>Name of column</td> <td>Name</td> <td>Age</td> <td>Height</td> <td>Weight</td> </tr> <tr> <td>Row 1</td> <td>John</td> <td>18</td> <td>180</td> <td>80</td> </tr> <tr> <td>Row 2</td> <td>Mary</td> <td>30</td> <td>150</td> <td>50</td> </tr> <tr> <td>Row 3</td> <td>Mark</td> <td>65</td> <td>170</td> <td>65</td> </tr> </table> <p>Column 1   Column 2   Column 3   Column 4</p> | Number of rows | 3      |        |  |  | Name of column | Name | Age | Height | Weight | Row 1 | John | 18 | 180 | 80 | Row 2 | Mary | 30 | 150 | 50 | Row 3 | Mark | 65 | 170 | 65 |
| Number of rows   | 3   |                |        |        |  |  |                |      |     |        |        |       |      |    |     |    |       |      |    |     |    |       |      |    |     |    |
| Name of column   | Name  | Age            | Height | Weight |  |  |                |      |     |        |        |       |      |    |     |    |       |      |    |     |    |       |      |    |     |    |
| Row 1  | John  | 18             | 180    | 80     |  |  |                |      |     |        |        |       |      |    |     |    |       |      |    |     |    |       |      |    |     |    |
| Row 2  | Mary  | 30             | 150    | 50     |  |  |                |      |     |        |        |       |      |    |     |    |       |      |    |     |    |       |      |    |     |    |
| Row 3  | Mark  | 65             | 170    | 65     |  |  |                |      |     |        |        |       |      |    |     |    |       |      |    |     |    |       |      |    |     |    |

### Sample Code 2: (since VA1.97)

```
DOWNLOAD "TEST.CSV",121,6,  
Number,String  
1234,ABCD  
"12,34","AB,CD"  
"12  
34","AB  
CD"  
"12""34","AB""CD"  
""1234","""ABCD"  
"1234""","ABCD"""
```

```
OUT RECORDSET$("TEST.CSV", 1, "Number", ASC(","))  
OUT RECORDSET$("TEST.CSV", 2, 1, ASC(","))  
OUT RECORDSET$("TEST.CSV", 3, 1, ASC(","))  
OUT RECORDSET$("TEST.CSV", 4, 1, ASC(","))  
OUT RECORDSET$("TEST.CSV", 5, 1, ASC(","))  
OUT RECORDSET$("TEST.CSV", 6, 1, ASC(","))
```

```
OUT ""
```

```
OUT RECORDSET$("TEST.CSV", 1, "String", ASC(","))  
OUT RECORDSET$("TEST.CSV", 2, 2, ASC(","))  
OUT RECORDSET$("TEST.CSV", 3, 2, ASC(","))  
OUT RECORDSET$("TEST.CSV", 4, 2, ASC(","))  
OUT RECORDSET$("TEST.CSV", 5, 2, ASC(","))  
OUT RECORDSET$("TEST.CSV", 6, 2, ASC(","))
```

### Table format (TEST.CSV)

| Number of rows | 6        |          |
|----------------|----------|----------|
| Name of column | Number   | String   |
| Row 1          | 1234     | ABCD     |
| Row 2          | 12,34    | AB,CD    |
| Row 3          | 12<br>34 | AB<br>CD |
| Row 4          | 12"34    | AB"CD    |
| Row 5          | "1234    | "ABCD    |
| Row 6          | 1234"    | ABCD"    |

Column 1      Column 2

### Return

```
1234  
12, 34  
12  
34  
12"34  
"1234  
1234"  
  
ABCD  
AB, CD  
AB  
CD  
AB"CD  
"ABCD  
ABCD"
```

## ● LABELRATIO

### Description

This command returns label print ratio.

### Syntax

**LABELRATIO**

### Note:

*This command has been supported since V8.00 EZ and later firmware*

### Example

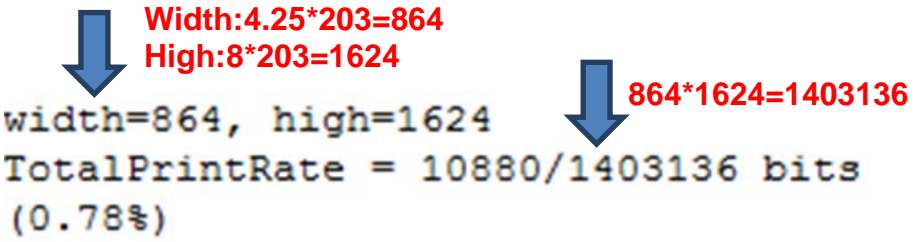
| Sample Code | Result   |
|-------------|--|
| LABELRATIO  |  <p>Width: <math>4.25 * 203 = 864</math><br/>High: <math>8 * 203 = 1624</math></p> <p>width=864, high=1624</p> <p><math>864 * 1624 = 1403136</math></p> <p>TotalPrintRate = 10880/1403136 bits<br/>(0.78%)</p> |

## ● REPLACE\$()

### Description

This command returns a string in which a specified substring has been replaced with another substring.

### Syntax

**LABELRATIO\$ ("str1\$"," sub1\$"," sub2\$")**

| <u>Parameter</u> | <u>Description</u>  |
|------------------|---|
| str1\$           | Required. The string that will be searched for replacing. |
| sub1\$           | Required. The specified substring that will be replaced.  |
| sub2\$           | Required. Replacement substring.                          |

**Note:**  
*This command has been supported since A1.92 EZD and later firmware.*

### Example

| <u>Sample Code</u>  | <u>Result</u>   |
|---|---|
| <pre>DOWNLOAD F,"TEST.BAS"<br/>SIZE 3,2<br/>GAP 0,0<br/>DIRECTION 1<br/>INPUT A\$<br/>DATA\$ =<br/>REPLACE\$(A\$,"ABC","123")<br/>CLS<br/>TEXT 100,100,"3",0,1,1,DATA\$<br/>PRINT 1<br/>EOP<br/>TEST<br/>ABCDEF</pre> |  |

# Device Reconfiguration Commands

## ● SET COUNTER

### Description

Counters can be a real counter or a variable. This setting sets the counter number in the program and its increments. There are three different types of counters: digit (0~9~0), lower case letter (a~z~a) or upper case letter (A~Z~A).

### Syntax

**SET COUNTER @n step**  
**@n= "Expression "**

| <u>Parameter</u> | <u>Description</u>   |
|------------------|--|
| @n               | n: counter number. There are 61 counters available (@0 ~ @60) in the printer. @0 to @50 will be cleared while restarting the printer. @51 to @60 will be stored in printer until the printer is restored to factory default.<br><b>@51~@55 were supported since V6.37 EZ.</b><br><b>@56~@60 were supported since V6.74 EZ.</b> |
| Step             | The increment of the counter, can be positive or negative.<br>-999999999 <= step <= 999999999<br><i>If the counter is used as a fixed variable, please set the increment to 0.</i>   |
| Expression       | Initial string. String length is 101 bytes   |

### Example

| <u>Sample Code</u>   | <u>Result</u>  |
|--|--|
| <pre> SET COUNTER @0 +1 SET COUNTER @1 +0 SET COUNTER @2 -1 SET COUNTER @3 1  @0=" 0001" @1=" 0101" @2=" 000A" @3=" 1"  SIZE 4,0.5 GAP 0,0 DIRECTION 1 CLS TEXT 600,10," 3",0,1,1,3," @0      @1      @2" TEXT 600,30," 3",0,1,1,3,« Label"  +@3+" -----" TEXT 600,50,"3",0,1,1,3,@0+"      "  +@1+"      "  +@2" PRINT 5           </pre> | <pre> Label 5  -----e0-----e1-----e2           0005      0101      999W  Label 4  -----e0-----e1-----e2           0004      0101      999X  Label 3  -----e0-----e1-----e2           0003      0101      999Y  Label 2  -----e0-----e1-----e2           0002      0101      999Z  Label 1  -----e0-----e1-----e2           0001      0101      000A           </pre> |

### See Also

PRINT, TEXT, BARCODE

## ● SET CUTTER

### Description

This setting activates or deactivates the cutter and defines how many printed labels is to be cut at one time. This setting will be saved in printer memory after turning off the power.

### Syntax

SET CUTTER OFF/BATCH/pieces

| <u>Parameter</u>  | <u>Description</u>  |
|---|---|
| OFF   | Disable cutter function.                                  |
| BATCH   | Set printer to cut label at the end of printing job.      |
| Pieces  | Set number of printing labels per cut. 0<= pieces <=65535 |
| <b>Note:</b>  |   |
| <ul style="list-style-type: none"> <li>• Care label cutter module was supported since V6.86 EZ in industrial printer TTP-2410M series.</li> <li>• Since V6.86 EZ, if cutter is not installed, the cutter error doesn't happen even SET CUTTER ON is set.</li> </ul> |   |

### Example

| <u>Sample code</u>   | <u>Result</u>                                    |
|--|--|
| SIZE 3,3<br>GAP 0,0<br>SET CUTTER OFF<br>SET PEEL OFF<br>CLS<br>TEXT 50,50, "3",0,1,1, "SET CUTTER OFF"<br>PRINT 3 | The cutter function is disabling.                |
| SET CUTTER BATCH<br>CLS<br>TEXT 50,50, "3",0,1,1, "SET CUTTER BATCH"<br>PRINT 3,2                                  | The cutter cuts once after 6 labels are printed. |
| SET CUTTER 1<br>CLS<br>TEXT 50,50, "3",0,1,1, "SET CUTTER 1"<br>PRINT 3,2  | The cutter cuts every label.                     |
| CLS<br>TEXT 50,50, "3",0,1,1, "SET CUTTER 2"<br>PRINT 3,2  | The cutter cuts every 2 labels.                  |

### See Also

OFFSET, PRINT, SET PARTIAL\_CUTTER

## ● SET PARTIAL\_CUTTER

### Description

This setting activates or deactivates the cutter and defines how many printed labels is to be cut at one time. This setting will be saved in printer memory after turning off the power. This function prevents label back feeding after a cut.

### Syntax

**SET PARTIAL\_CUTTER OFF/BATCH/Pieces**

| <u>Parameter</u> | <u>Description</u>  |
|------------------|---|
| OFF              | Disable cutter function.                                  |
| BATCH            | Set printer to cut label at the end of printing job.      |
| Pieces           | Set number of printing labels per cut. 0<= pieces <=65535 |

Note: This command is supported for the printer that have cutter module.

### Example

#### Sample code

```
REM **SET PARTIAL_CUTTER FUNCTION OFF EXAMPLE PROGRAM**
SIZE 3,1
GAP 0,0
DENSITY 8
SPEED 6
DIRECTION 0
REFERENCE 0,0
SET PARTIAL_CUTTER OFF
CLS
TEXT 50,50, "3",0,1,1, "SET PARTIAL_CUTTER OFF"
PRINT 3
REM ***This program cuts once at the batch***
SET PARTIAL_CUTTER BATCH
CLS
TEXT 50,50, "3",0,1,1, "SET PARTIAL_CUTTER BATCH"
PRINT 3,2
REM ***This program cuts every label***
SET PARTIAL_CUTTER 1
CLS
TEXT 50,50, "3",0,1,1, " SET PARTIAL_CUTTER 1"
PRINT 3,2
REM ***This program cuts 2 label***
SET PARTIAL_CUTTER 2
CLS
TEXT 50,50, "3",0,1,1, "SET PARTIAL_CUTTER 2"
PRINT 3,2
```

### See Also

OFFSET, PRINT, SET CUTTER



## ● SET BACK

### Description

This setting is used after SET CUTTER function. This function prevents label backfeeding after a cut.

### Syntax

**SET BACK OFF/ON**

| <u>Parameter</u> | <u>Description</u>     |
|------------------|------------------------|
| OFF              | Disable back function. |
| ON               | Enable back function.  |

Note: TDP-643 Plus , TTP-243, TTP-342, TTP-244ME, TTP-342M and TTP-248M series are not supported this feature

### Example

#### Sample code

```
REM **SET BACK FUNCTION OFF EXAMPLE PROGRAM**
SIZE 3,1
GAP 0,0
DENSITY 8
SPEED 6
DIRECTION 1
REFERENCE 0,0
SET CUTTER 1
SET BACK OFF
CLS
TEXT 50,50, "3",0,1,1, "SET BACK OFF "
PRINT 3
CLS
SET CUTTER 1
SET BACK ON
TEXT 50,50, "3",0,1,1, "SET BACK ON "
PRINT 3
```

### See Also

OFFSET, PRINT, SET CUTTER

## ● SET KEYn

### Description

This setting is used to enable/disable the KEYn function. Before setting KEYn function, please disable the default function of KEYn first. The setting will remain resident in the printer even when the printer is power off.

### Syntax

**SET KEYn ON/OFF/DEFAULT/MENU/PAUSE/PRINT m/FEED/BACKFEED/FORMFEED/CUT/INPUT "string "**

| <u>Parameter</u> | <u>Description</u>  |
|------------------|---|
| n                | 0, 1, 2, 3, 4, 5, 6   |
| ON               | Enable KEYn function  |
| OFF              | Disable KEYn function   |
| DEFAULT          | Resume KEYn default function  |
| MENU             | Set to "MENU " key  |
| PAUSE            | Set to "PAUSE " key   |
| PRINT m          | Set to "PRINT " key<br>m: Set number of printing labels per print. (0 < m < 32000)                              |
| FEED             | Set to "FEED " key that can manual control the feeding distance   |
| BACKFEED         | Set to "BACKFEED " key that can manual control the backfeeding distance   |
| FORMFEED         | Set to "FORMFEED " key that will feed the label under the format. Ex: If format is "size 4,6, it will feed 6 ". |
| CUT              | Set to "CUT " key   |
| INPUT "string "  | Send the command by press key (ex: <b>SET KEY1 INPUT "CONFIG " + CHR\$(13) + CHR\$(10) )</b>                    |

The default function of KEYn is as listed below:

| Model   | KEY0 | KEY1  | KEY2  | KEY3  | KEY4  | KEY5   | KEY6     |
|---|------|-------|-------|-------|-------|--------|----------|
| TDP-643 Plus/ 643R Plus   |      | PAUSE |       |       |       |        |          |
| TTP-243/243 Plus/243 Pro series, TTP-244ME/244 ME Plus/244M Pro series, TTP-244/244 Plus series   |      | PAUSE | FEED  |       |       |        |          |
| TDP-245/247 series, TTP-245/247 series, TTP-245C series, TDP-225 series, TTP-225 series, TA200 series, Alpha-3R, DA series, TE series, Alpha-2R |      | FEED  |       |       |       |        |          |
| TX200 series (with LCD), TC210 series (with LCD), TX600 series, MX240P series, MH series, ML240P series, MB240T series                          |      | FEED  | MENU  | UP    | RIGHT | LEFT   | DOWN     |
| TTP-246M series   |      | MENU  | PAUSE | FEED  | (UP)  | (DOWN) | (SELECT) |
| TTP-248M series   |      | MENU  | PAUSE | FEED  |       |        |          |
| TTP-2410M/2410M Pro series, TTP-246M Plus/246M Pro series, TTP-268M series, TTP-384M series, ME240(with LCD) series                             |      | MENU  | PAUSE | FEED  | UP    | DOWN   | SELECT   |
| ME240 (Non-LCD) series, ML240 series, MB240 series  |      | FEED  | PAUSE |       |       |        |          |
| M23 series  | FEED | LEFT  | MID   | RIGHT |       |        |          |
| Alpha-4L  |      | FEED  | INFO  | MENU  |       |        |          |
| MX240 series, TTP-2410MT/MU series  |      | PAUSE | MENU  | FEED  | UP    | SELECT | DOWN     |

**Note:** Please refer to [printer model list](#) for more detail

## Example

### Sample code

```
DOWNLOAD "DEMO.BAS"
SIZE 3,1
GAP 0,0
DENSITY 8
SPEED 3
DIRECTION 0
REFERENCE 0,0
SET CUTTER OFF
SET KEY1 OFF
SET KEY2 OFF
SET KEY3 OFF
KEY1=0
KEY2=0
KEY3=0

:START
IF KEY1=1 THEN
CLS
TEXT 100,10, "3",0,1,1, "KEY1 (MENU key) is pressed!! "
PRINT 1,1
ELSEIF KEY2=1 THEN
CLS
TEXT 100,10, "3",0,1,1, "KEY2 (PAUSE key) is pressed!! "
PRINT 1,1
ELSEIF KEY3=1 THEN
CLS
TEXT 100,10, "3",0,1,1, "KEY3 (FEED key) is pressed!! "
TEXT 100,60, "3",0,1,1, "End of test"
PRINT 1,1
SET KEY1 ON
SET KEY2 ON
SET KEY3 ON
END
ENDIF
GOTO START
EOP
DEMO
```

## See Also

OFFEST, PRINT

## ● SET LEDn

### Description

This setting is used to control LED on/off function.

### Syntax

SET LED1 ON/OFF

SET LED2 ON/OFF

SET LED3 ON/OFF

| <u>LED no.</u> | <u>Default Function</u>  |
|----------------|--------------------------|
| LDE1           | Power on/off             |
| LED2           | Printer on-line/off-line |
| LED3           | Error/normal             |

| <u>Parameter</u> | <u>Description</u>    |
|------------------|-----------------------|
| ON               | Enable LEDn function  |
| OFF              | Disable LEDn function |

The default function of LED1, LED2 and LED3 id as listed below:

| Model  | LED1   | LED2   | LED3  | LED4 | LED5 | LED6    | LED7 | LED2 & LED3 |
|--|--------|--------|-------|------|------|---------|------|-------------|
| TDP-643 Plus/ 643R Plus series   | ONLINE | ERROR  | ERROR |      |      |         |      |             |
| TTP-243/243 Plus/243 Pro series,<br>TTP-244ME/244 ME Plus/244M Pro series,<br>TTP-244/ 244 Plus series<br>TTP-2410M/2410M Pro series,<br>TTP-246M Plus/246M Pro series,<br>TTP-268M series, TTP-384M series,<br>ME240 series, MX240 series,<br>MX240P series | POWER  | ONLINE | ERROR |      |      |         |      |             |
| TDP-245/247 series, TTP-245/247 series,<br>TTP-245C series, TDP-225 series,<br>TTP-225 series, DA200 series,<br>TA200 series, TC210series, TE200 series,<br>MH series<br><b>Note: For this series, the LED1=LED2</b>   | GREEN  | GREEN  | RED   |      |      |         |      | ORANGE      |
| Alpha-2R series , Alpha-3R series  | GREEN  | RED    | BAT1  | BAT2 | BAT3 | BT/WIFI |      | ORANGE      |
| Alpha-4L series  | GREEN  | RED    | BAT1  | BAT2 | BAT3 | BT      | WIFI | ORANGE      |

*Note: Please refer to [printer model list](#) for checking series printers.*

### Example

#### Sample code

```

DOWNLOAD "DEMO4.BAS "
SET LED1 OFF
SET LED2 OFF
SET LED3 OFF
FOR I=1 TO 100
LED1=0
LED2=0
LED3=0
IF I-INT(I/2)*2=0 THEN
LED1=1

```

```
ELSEIF I-INT(I/3)*3=0 THEN
```

```
LED2=1
```

```
ELSE
```

```
LED3=1
```

```
ENDIF
```

```
NEXT
```

```
LED1=1
```

```
LED2=1
```

```
LED3=0
```

```
SET LED1 ON
```

```
SET LED2 ON
```

```
SET LED3 ON
```

```
EOP
```

```
DEMO4
```

## ● SET PEEL

### Description

This setting is used to enable/disable the self-peeling function. The default setting for this function is off. When this function is set on, the printer stops after each label printing, and does not print the next label until the peeled label is taken away. This setting will be saved in printer memory when turning off the power.

### Syntax

**SET PEEL ON/OFF**

| <u>Parameter</u> | <u>Description</u>                |
|------------------|-----------------------------------|
| ON               | Enable the self-peeling function  |
| OFF              | Disable the self-peeling function |

### Example

#### Sample code

```
REM ***SELF-PEELING FUNCTION ON***  
SIZE 4,4  
GAP 0,0  
DENSITY 8  
SPEED 6  
DIRECTION 0  
REFERENCE 0,0  
SET CUTTER OFF  
SET PEEL ON  
CLS  
TEXT 50,100, "3 ",0,1,1, "SELF-PEELING FUNCTION TEST "  
PRINT 5
```

### See Also

OFFEST, PRINT

## ● SET REWIND

### Description

This setting is used to enable/disable the internal rewind function for MX240/TTP-2610MT series & external rewind module (via RS-232 port). The default setting for this function is off. When this function is set on, the printer rewind spindle will rewind the printed labels. This setting will be saved in printer memory when turning off the power.

### Syntax

**SET REWIND ON/OFF/RS232**

| <u>Parameter</u> | <u>Description</u>   |
|------------------|--|
| ON               | Enable the internal rewind function  |
| OFF              | Disable the internal rewind or external rewind module function                 |
| RS232            | Enable the external rewind module function (via RS-232 port/ pull high signal) |

*Note: The function of external rewind module has been supported since A1.92 and later firmware.*

### Example

#### Sample code

```
REM ***REWIND FUNCTION ON***  
SIZE 4,4  
GAP 0.12,0  
DENSITY 8  
SPEED 6  
DIRECTION 0  
REFERENCE 0,0  
SET CUTTER OFF  
SET REWIND ON  
CLS  
TEXT 50,100, "3 ",0,1,1, "REWIND FUNCTION TEST "  
PRINT 500
```

### See Also

OFFEST, PRINT

## ● SET TEAR & SET STRIPER

### Description

This command is used to enable/disable feeding of labels to gap/black mark position for tearing off. This setting will be saved in printer memory when turning off the power.

### Syntax

**SET TEAR ON/OFF** (TSPL2 language printers only)  
**SET STRIPER ON/OFF** (TSPL language printers only)

Note: Please refer to [printer model list](#) for checking TSPL or TSPL2

| <u>Parameter</u> | <u>Description</u>  |
|------------------|---|
| ON               | The label gap will stop at the tear off position after print.   |
| OFF              | The label gap will NOT stop at the tear off position after print. The beginning of label will be aligned to print head. |

### Example

#### Sample code

```
REM ***TEAR FUNCTION ON***  
SIZE 3,3  
GAP 0.08,0  
DENSITY 8  
SPEED 4  
DIRECTION 0  
REFERENCE 0,0  
SET CUTTER OFF  
SET PEEL OFF  
SET TEAR ON  
CLS  
TEXT 50,100, "3 ",0,1,1, "TEAR FUNCTION TEST "  
PRINT 1
```

### See Also

SET PEEL, SET CUTTER



## ● SET GAP

### Description

This setting sets the gap sensor emission sensitivity. The printer initiates automatic gap sensor calibration when the PAUSE key is held down while powering up. This function may cease to work if the thickness of the backing paper and that of label with backing paper are not of appreciable difference to the sensor, or when there are pre-printed marks or patterns on the label. In such case, users must calibrate the gap sensor manually by this command through trial-and-error method to attain the proper setting. This setting will be saved in printer memory when turning off the power.

### Syntax

**SET GAP n/AUTO/OFF/0,/REVERSE/OBVERSE**

| <u>Parameter</u> | <u>Description</u>   |
|------------------|--|
| N                | Gap sensor light emission strength. Available range is listed as below. 0 is the lowest sensitivity  |
| AUTO             | The printer will feed 2 or 3 labels to calibrate the gap. If the label is continuous, the printer will feed label to limit 10~20 inches to confirm if the label is continuous.   |
| OFF              | Disable the SET GAP AUTO function.   |
| 0,               | Automatically calibrate the gap size.  |
| REVERSE          | This function is used when the Black Mark is the separation in the front of the label and which can't be detected by the Black Mark sensor. The parts of the media which can be passed through by GAP sensor are defined to be the printable area, otherwise it will be defined to the GAP of the media. |
| OBVERSE          | Disable the "SET GAP REVERSE " function.   |

| Printer model  | Gap Sensor Range | Black Mark Sensor Range | SET GAP REVERSE<br>SET GAP OBVERSE<br>SET GAP AUTO |
|--|------------------|-------------------------|--|
| TTP-243 series, TTP-244ME series, TDP-643 Plus series, TTP-342 series, TTP-342M series                                 | 0~15             | ON/OFF                  | <b>V</b>   |
| TTP-243 Plus series, TTP-244 series, TTP-244ME Plus series, TDP-643R Plus series, TTP-342 Plus series                  | 0~255            | ON/OFF                  | <b>V</b>   |
| TTP-243 Pro series, TTP-244 Plus series  | 0~63             | ON/OFF                  |  |
| TTP-245C series, TTP-225 series, TDP-225 series  | 0~31             | 0~3                     | <b>V</b>   |
| TTP-245/343 series, TDP-245 series, TTP-246M/344M series (non usb)   | 0~63             | 0~63                    | <b>V</b>   |
| TTP-245 Plus/343 Plus series, TDP-245 Plus series, TTP-247 series, TDP-247 series                                      | 0~15             | 0~15                    | <b>V</b>   |
| TTP-246M/344M series (usb)   | 0~31             | 0~31                    | <b>V</b>   |
| TTP-246M Plus, TTP-2410M series, TTP-344M Plus series, TTP-346M series, TTP-384M series, TTP-644M series, ME240 series | 0~7              | 0~3                     | <b>V</b>   |
| TTP-2410M Pro series   | 0~7              | 0~7                     | <b>V</b>   |
| TTP-248M series, M23 series  | 0~255            | 0~255                   | <b>V</b>   |
| TA200 series   | 0~15             | 0~3                     | <b>V</b>   |
| Alpha-4L series  | 0~15             | 0~7                     | <b>V</b>   |

**Note:**

\* When in "SET HEAD OFF " mode, the function "SET GAP AUTO " doesn't work even the printer head is opened and closed, but it can work when power on the printer.

\* Please refer to [printer model list](#) for checking series printers.

## Example

The example below is operated in DOS environment via the parallel port connection to setup the label size, gap distance and sensor sensitivity.

```
C:\>COPY CON LPT1<ENTER>  
SIZE 4,2.5<ENTER>  
GAP 0.12,0<ENTER>  
SET GAP 1<ENTER>  
<CTRL><Z><ENTER>  
C:\>
```

### **Note:**

*<ENTER> stands for keyboard "ENTER " key. In the above example, please press "ENTER " key instead of typing <ENTER> in the above example. <CTRL> stands for keyboard "Ctrl" key.*

### **Troubleshooting:**

Press the FEED key to test. Does printer stop at the same position on each label without the error light blinking? If not, adjust the setting to a larger number. When adjusting this setting, begin from 0 and then on to higher values-incrementally.

## See Also

SIZE, GAP, BLINE

## ● SET BLINE

### Description

This setting is using to reverse/obverse the sensor function.

### Syntax

**SET BLINE REVERSE/OBVERSE**

| <u>Parameter</u> | <u>Description</u>  |
|------------------|---|
| REVERSE          | Reverse the sensor function. Redefine the reflective area is black line and non-reflective part is paper. (Normally, reflective part is paper and non-reflective part is black line.) |
| OBVERSE          | Disable the "SET BLINE REVERSE" function.   |

## ● SET HEAD

### Description

This setting is used to enable/disable head open sensor. If the head open sensor is turned off, an open printer head will not return an error message. This setting will be saved in printer memory. This command is only available for TSPL2 printers.

Note: Please refer to [printer model list](#) for checking TSPL2 printers.

### Syntax

**SET HEAD ON /OFF**

| <u>Parameter</u> | <u>Description</u>               |
|------------------|----------------------------------|
| ON               | Turn on the "HEAD OPEN " sensor  |
| OFF              | Turn off the "HEAD OPEN " sensor |

### Example

SET HEAD ON  
SET HEAD OFF

## ● SET RIBBON

### Description

This setting is used to enable/disable ribbon sensor detection. (Thermal Transfer Printing/Thermal Direct Printing) Printer will detect the presence of a ribbon to determine using either direct thermal or thermal transfer printing upon printer startup. This setting will NOT be saved in printer memory.

### Syntax

SET RIBBON ON/OFF/INSIDE/OUTSIDE

| <u>Parameter</u> | <u>Description</u>   |
|------------------|--|
| ON               | Thermal transfer printing  |
| OFF              | Thermal direct printing  |
| INSIDE           | The ribbon is inside wound. For TTP-384M only. <i>*Since V6.80EZ.</i>  |
| OUTSIDE          | The ribbon is outside wound. For TTP-384M only. <i>*Since V6.80EZ.</i> |

### Example

```
Sample Code

REM *****Disable ribbon detection sensor for direct thermal printing.
SET RIBBON OFF
SIZE 4,1
GAP 0,0
CLS
TEXT 10,10, " 3 " ,0,1,1, " Direct thermal printing. "
PRINT 1

REM *****Enable ribbon detection sensor for thermal transfer printing.
SET RIBBON ON
SIZE 4,1
GAP 0,0
CLS
TEXT 10,10, " 3 " ,0,1,1, " Thermal transfer printing. "
PRINT 1

REM *****For using ink-in ribbon in TTP-384M.
SET RIBBON INSIDE
SIZE 4,1
GAP 0,0
CLS
TEXT 10,10, " 3 " ,0,1,1, " TTP-384M is using ink-in ribbon. "
PRINT 1

REM *****For using ink-out ribbon in TTP-384M.
SET RIBBON OUTSIDE
SIZE 4,1
GAP 0,0
CLS
TEXT 10,10, " 3 " ,0,1,1, " TTP-384M is using ink-out ribbon. "
PRINT 1
```

## ● SET ENCODER

### Description

This setting is used to enable/disable ribbon encoder sensor detection.

### Syntax

**SET ENCODER ON/OFF**

| <u>Parameter</u> | <u>Description</u>             |
|------------------|--------------------------------|
| ON               | Enable ribbon encoder sensor.  |
| OFF              | Disable ribbon encoder sensor. |

### Example

**SET ENCODER ON**

**SET ENCODER OFF**

## ● SET RIBBONEND

### Description

This setting is used to enable/disable ribbon-end sensor detection.

### Syntax

**SET RIBBONEND ON/OFF**

| <u>Parameter</u> | <u>Description</u>         |
|------------------|----------------------------|
| ON               | Enable ribbon-end sensor.  |
| OFF              | Disable ribbon-end sensor. |

**Note:**  
*This command has been supported since V6.91 EZ and later firmware.*

### Example

**SET RIBBONEND ON**  
**SET RIBBONEND OFF**

## ● SET COM1

### Description

This setting defines communication parameters for printer serial port.

### Syntax

**SET COM1 baud,parity,data,stop**

| <u>Parameter</u> | <u>Description</u>  |
|------------------|---|
| baud             | Baud rate, available baud rates are as listed :<br>24: 2400 bps<br>48: 4800 bps<br>96: 9600 bps<br>19: 19200 bps<br>38: 38400 bps<br>57: 57600 bps<br>115: 115200 bps |
| parity           | Parity check<br>N: No parity check<br>E: Even parity check<br>O: Odd parity check   |
| Data             | Data bit<br>8: 8 bits data<br>7: 7 bits data  |
| stop             | Stop bit<br>1: 1 stop bit<br>2: 2 stop bits   |

### Example

The parallel port is used to setup the printer serial port in this example via MS-DOS mode.

```
C:\>COPY CON LPT1<ENTER>  
SET COM1 19,N,8,1<ENTER>  
<CTRL><Z><ENTER>  
C:\>
```

**Note:**

*<ENTER> stands for PC keyboard "ENTER" key. <CTRL><Z> means to hold PC keyboard "CTRL" key then press the PC keyboard <Z> key.*



## ● SET PRINTKEY

### Description

This command will print one label and feed label gap to tear bar position for tearing away. Press FEED button to print the next label or batch of labels. If label content includes serial text or barcode, it will change the serial number accordingly. This setting will be saved in printer memory.

### Syntax

**SET PRINTKEY OFF/ON/AUTO/<num>**

| <u>Parameter</u> | <u>Description</u>   |
|------------------|--|
| OFF              | Disable this function  |
| ON               | Enable this function   |
| AUTO             | Enable this function   |
| <num>            | Numbers of labels will be printed if FEED button is pressed. |

**Note:** This command is only available for TSPL2 printers. Please refer to [printer model list](#) for checking TSPL2 printers.

### Example

#### Sample code

```
SIZE 4,2.5
GAP 0.12,0
SET PRINTKEY ON
SET COUNTER @0 1
@0= "0001"
CLS
TEXT 10,10, "5",0,1,1,@0
PRINT 1
```

#### Execute:

| Syntax  | Receive "PRINT m"  | Print Out |
|---|--------------------|-----------|
| <b>SET PRINTKEY ON</b> or<br><b>SET PRINTKEY AUTO</b> | 1.) PRINT 2        | Label 1~2 |
|   | 2.) Press FEED key | Label 3~4 |

| Syntax  | Receive "PRINT m,n" | Print Out        |
|---|---------------------|------------------|
| <b>SET PRINTKEY ON</b> or<br><b>SET PRINTKEY AUTO</b> | 1.) PRINT 1,2       | Label 1, Label 1 |
|   | 2.) Press FEED key  | Label 2, Label 2 |

| Syntax  | Receive "PRINT -1,n" | Print Out        |
|---|----------------------|------------------|
| <b>SET PRINTKEY ON</b> or<br><b>SET PRINTKEY AUTO</b> | 1.) PRINT -1,2       | Label 1, Label 1 |
|   | 2.) Press FEED key   | Label 1, Label 1 |

| Syntax                | Receive "PRINT m"   | Print Out        |
|-----------------------|---------------------|------------------|
| <b>SET PRINTKEY 5</b> | 1.) PRINT 2         | Label 1~2        |
|                       | 2.) Press FEED key  | Label 3~7        |
| Syntax                | Receive "PRINT m,n" | Print Out        |
| <b>SET PRINTKEY 5</b> | 1.) PRINT 1,2       | Label 1, Label 1 |
|                       | 2.) Press FEED key  | Label 2~6        |

| Syntax         | Receive "PRINT -1,n" | Print Out        |
|----------------|----------------------|------------------|
| SET PRINTKEY 5 | 1.) PRINT -1,2       | Label 1, Label 1 |
|                | 2.) Press FEED key   | Label 1, Label 1 |

## ● SET REPRINT

### Description

This command will disable/enable a reprinting attempt subsequent to a “no paper”, “no ribbon” or “carriage open” error.

### Syntax

SET REPRINT OFF/ON

| <u>Parameter</u> | <u>Description</u>    |
|------------------|-----------------------|
| OFF              | Disable this function |
| ON               | Enable this function  |

**Note:** This command is only available for TSPL2 printers. Please refer to [printer model list](#) for checking TSPL2 printers.

### Example

SET REPRINT ON

## ● SET FEED\_LEN

### Description

This command can set the feeding length when FEED key is pressed. This setting will be memorized by printer. The initialized value is the label length.

### Syntax

SET FEED\_LEN n

| <u>Parameter</u> | <u>Description</u>         |
|------------------|----------------------------|
| n                | The feeding length in dot. |

**Note:**  
*This command has been supported since V5.10 EZ and later firmware.*

### Example

|  |
|--|
| <b>Sample code</b><br>SET FEED_LEN 100   |
| <b>Result</b><br>The feeding length is 100 dots when you press the FEED button after this setting. |

## ● GETSENSOR()

### Description

This command is used to get the sensor status/AD value. We can use it to check the sensor function.

### Syntax

**GETSENSOR(sensor\$[,intension])**

| <u>Parameter</u>  | <u>Description</u>              |   |
|---|---------------------------------|---|
| sensor\$  | Sensor type.                    |   |
|   | <b>GAP</b>                      | Gap sensor  |
|   | <b>BLINE</b>                    | Black mark sensor   |
|   | <b>RIBBON</b>                   | Ribbon-end sensor   |
|   | <b>PEEL</b>                     | Peeler sensor   |
|   | <b>HEAD UP</b>                  | Thermal print head open sensor  |
|   | <b>HEAD TEMP</b>                | The temperature of print head   |
|   | <b>HEAD VOLT</b>                | The voltage of print head   |
|   | <b>BATTERY VOLT</b>             | The voltage of battery (since A2.05 EZC)  |
|   | <b>BATTERY CAP</b>              | The capacity of battery (since A2.05 EZC)   |
| intension   | Sensor intension.               |   |
|   | <b>Gap</b> intension            | Please refer to SET GAP for gap sensor range of different model.  |
|   | <b>BLINE</b> intension          | Please refer to SET GAP for black mark sensor range of different model.                                 |
|   | <b>RIBBON</b> intension         | 0 ~ 3   |
|   | <b>PEEL</b> sensor intension    | Ignored   |
|   | <b>HEAD UP</b> sensor intension | Ignored   |
|   | <b>HEAD TEMP</b>                | Ignored   |
|   | <b>HEAD VOLT</b>                | Ignored   |
| Returned value  | <b>Gap</b>                      | Return the AD value of gap sensor   |
|   | <b>BLINE</b>                    | Return the AD value of black mark sensor  |
|   | <b>RIBBON</b>                   | Return the AD value of ribbon sensor  |
|   | <b>PEEL</b>                     | The return value will be either 0 or 1<br>0: Paper is not on the sensor<br>1: Paper is on the sensor    |
|   | <b>HEAD UP</b>                  | The return value will be either 0 or 1<br>0: print head module is close<br>1: print head module is open |
|   | <b>HEAD TEMP</b>                | Return the temperature of thermal print head  |
|   | <b>HEAD VOLT</b>                | Return the voltage of thermal print head  |
| <b>Note:</b><br><i>This command has been supported since V6.75 EZ and later firmware.</i> |                                 |   |

**Example (Use CommTool to get sensor status via RS-232.)**

**Sample code**

```
OUT GETSENSOR("GAP",0)
OUT GETSENSOR("GAP",1)
OUT GETSENSOR("GAP",2)
OUT GETSENSOR("GAP",3)
OUT GETSENSOR("GAP",4)
OUT GETSENSOR("GAP",5)
OUT GETSENSOR("GAP",6)
OUT GETSENSOR("GAP",7)
OUT GETSENSOR("GAP",8)
```

**Result**

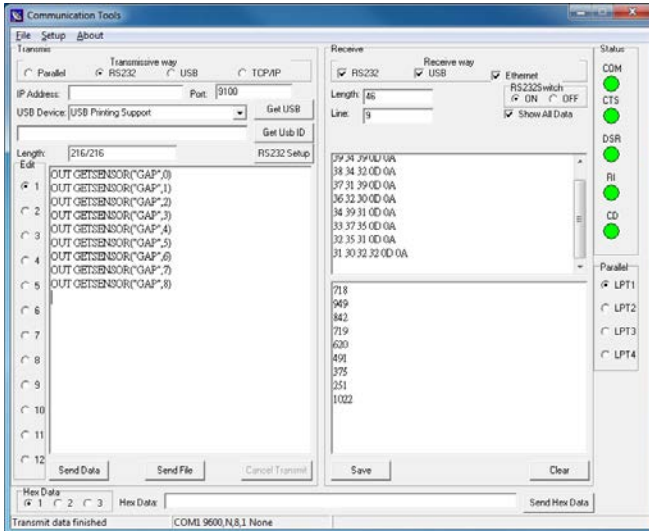

*\*If the returned valued is changed in different sensor intension, we can say the sensor is functional.*

**Sample code**

```
OUT GETSENSOR("BLINE",0)
OUT GETSENSOR("BLINE",1)
OUT GETSENSOR("BLINE",2)
OUT GETSENSOR("BLINE",3)
```

**Result**

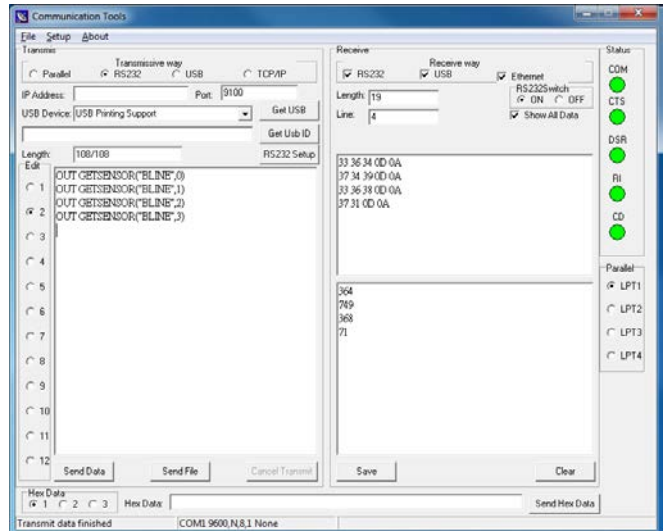

*\*If the returned valued is changed in different sensor intension, we can say the sensor is functional.*

**Sample code**

```
OUT GETSENSOR("RIBBON",0)
OUT GETSENSOR("RIBBON",1)
OUT GETSENSOR("RIBBON",2)
OUT GETSENSOR("RIBBON",3)
```

**Result**

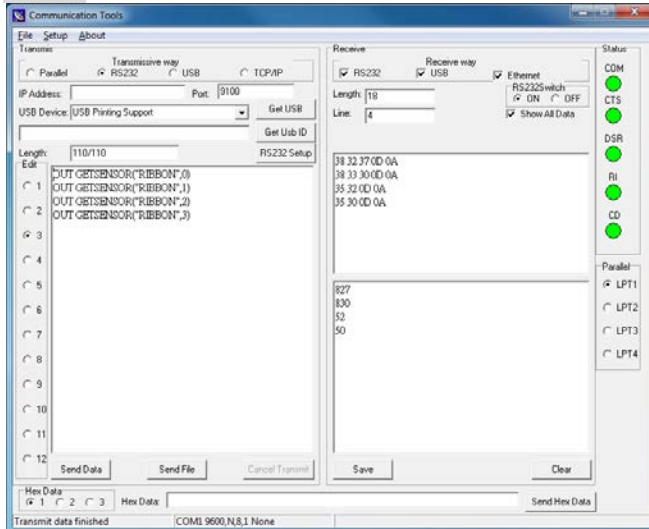

*\*If the returned valued is changed in different sensor intension, we can say the sensor is functional.*

**Sample code**

```
OUT GETSENSOR("PEEL")
```

**Result**

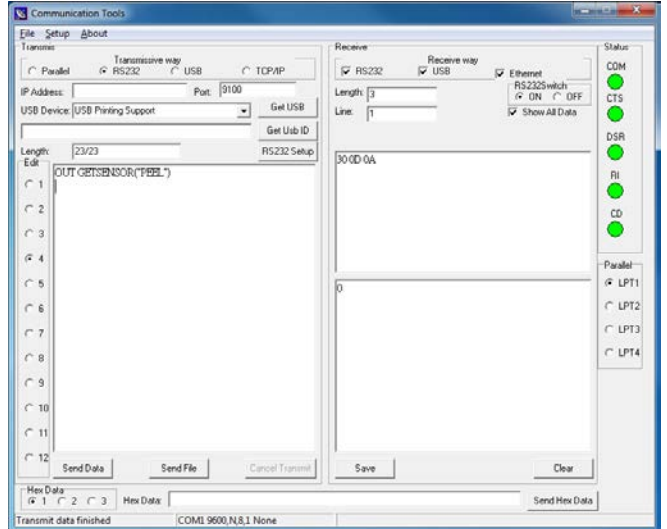

*\*0: Paper is not on the sensor. 1: Paper is on the sensor.*

## Sample code

```
OUT GETSENSOR("BATTERY VOLT")  
OUT GETSENSOR("BATTERY CAP")
```

## Result

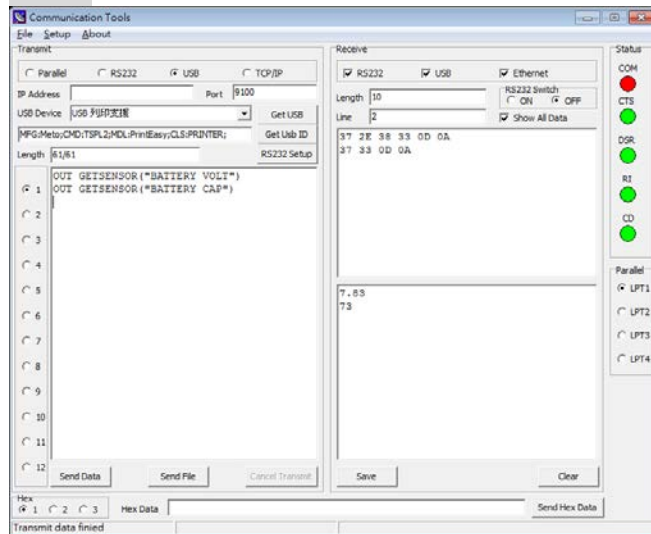

***\*This code used to detect the battery voltage and battery capacity for mobile Printer since A2.05 EZC and later firmware.***

## ● GETSETTING\$()

### Description

This command is used to get printer settings.

### Syntax

**GETSETTING\$ (app\$,sec\$,key\$[,default\$])**

| app\$        | sec\$                | key\$   | Comment                                |                     |
|--------------|----------------------|---|--|---------------------|
| SYSTEM       | INFORMATION          | DPI   | Return printer resolution              |                     |
|              |                      | MODEL   | Return printer model name              |                     |
|              |                      | SERIAL  | Return Printer serial number           |                     |
|              |                      | VERSION   | Return Printer firmware version        |                     |
|              |                      | CHECKSUM  | Return Printer firmware checksum       |                     |
|              | RECORD               | MILAGE  | Return printed mileage                 |                     |
|              |                      | CUT COUNTER   | Return cutter cuts                     |                     |
| FILE         | DRAM                 | CAPACITY  | Return the total capacity of DRAM      |                     |
|              |                      | AVAILABLE   | Return the available capacity of DRAM  |                     |
|              | FLASH                | CAPACITY  | Return the total capacity of FLASH     |                     |
|              |                      | AVAILABLE   | Return the available capacity of FLASH |                     |
|              | CARD                 | CAPACITY  | Return the total capacity of CARD      |                     |
|              |                      | AVAILABLE   | Return the available capacity of CARD  |                     |
| INSTALLED    |                      | Return the status of card. 1: installed; 0: none installed. |  |                     |
| CONFIG       | NET                  | MAC ADDRESS   | Return MAC address                     |                     |
|              |                      | IP ADDRESS  | Return IP address                      |                     |
|              |                      | SUBNET MASK   | Return Subnet Mask                     |                     |
|              |                      | DEFAULT GATEWAY   | Return default gateway                 |                     |
|              |                      | RAW PORT  | Return raw port                        |                     |
|              |                      | NAME  | Return printer name                    |                     |
|              |                      | PRIMARY DNS   | Return primary DNS                     | since V8.12 & A2.09 |
|              |                      | SECONDARY DNS   | Return secondary DNS                   |                     |
|              | WLAN                 | MAC ADDRESS   | Return MAC address                     |                     |
|              |                      | IP ADDRESS  | Return IP address                      |                     |
|              |                      | SUBNET MASK   | Return Subnet Mask                     |                     |
|              |                      | DEFAULT GATEWAY   | Return default gateway                 |                     |
|              |                      | RAW PORT  | Return raw port                        |                     |
|              | COM1                 | BAUD RATE   | Return baud rate of COM port           |                     |
|              |                      | DATA BIT  | Return data bit of COM port            |                     |
|              |                      | PARITY  | Return parity of COM port              |                     |
|              |                      | STOP BIT  | Return stop bit of COM port            |                     |
|              | SENSOR               | SENSOR TYPE   | Return the current sensor type         |                     |
|              |                      | CARRIAGE  | Return the status of head open sensor. |                     |
|              |                      | GAP INTENSION   | Return intension of gap sensor.        |                     |
|              |                      | BLINE INTENSION   | Return intension of black mark sensor. |                     |
|              |                      | CONTINUOUS INTENSION  | Return intension of continuous sensor. |                     |
|              | TSPL                 | PRINT MODE  | Return pos-print action.               |                     |
|              |                      | DENSITY   | Return print density                   |                     |
|              |                      | PAPER SIZE  | Return paper size                      |                     |
|              |                      | GAP SIZE  | Return gap size                        |                     |
|              |                      | BLINE SIZE  | Return black mark size                 |                     |
|              |                      | DIRECTION   | Return printing direction              |                     |
|              |                      | MIRROR  | Return mirror status.                  |                     |
|              |                      | RIBBON  | Return ribbon status.                  |                     |
| REPRINT      |                      | Return reprint status.                                      |  |                     |
| PAPER WIDTH  |                      | Return paper width  |  |                     |
| LIMIT FEED   |                      | Return maximum length for sensor calibration.               |  |                     |
| OFFSET       |                      | Return OFFSET value.  |  |                     |
| REFERENCE X  |                      | Return REFERENCE X value.                                   |  |                     |
| REFERENCE Y  |                      | Return REFERENCE Y value.                                   |  |                     |
| SHIFT X      |                      | Return SHIFT X value.                                       |  |                     |
| SHIFT Y      |                      | Return SHIFT Y value.                                       |  |                     |
| SPEED        |                      | Return print speed.   |  |                     |
| COUNTRY CODE | Return COUNTRY code. |   |  |                     |
| CODEPAGE     | Return CODEPAGE.     |   |  |                     |



| <u>Parameter</u> | <u>Description</u>   |
|------------------|--|
| default\$        | Optional. Expression containing the value to return if no value is set in the key\$ setting. If omitted, default is assumed to be a zero-length string (""). |

**Note:** This command has been supported since V6.72 EZ and later firmware.

## Example

### Sample code (Use CommTool to get printer settings via RS-232.)

```

OUT "DPI = ";GETSETTING$("SYSTEM","INFORMATION","DPI")
OUT " MODEL =";GETSETTING$("SYSTEM", " INFORMATION ", " MODEL")
OUT "SERIAL = ";GETSETTING$("SYSTEM","INFORMATION","SERIAL")
OUT "VERSION = ";GETSETTING$("SYSTEM", "INFORMATION", "VERSION")
OUT "CHECKSUM = ";GETSETTING$("SYSTEM","INFORMATION","CHECKSUM")
OUT "MILAGE = ";GETSETTING$("SYSTEM", "RECORD", "MILAGE")
OUT "CUT COUNTER = ";GETSETTING$("SYSTEM","RECORD","CUT COUNTER")
OUT "DRAM CAPACITY = ";GETSETTING$("FILE", "DRAM", "CAPACITY")
OUT "DRAM AVAILABLE = ";GETSETTING$("FILE", "DRAM", "AVAILABLE")
OUT "FLASH CAPACITY = ";GETSETTING$("FILE", "FLASH", "CAPACITY")
OUT "FLASH AVAILABLE = ";GETSETTING$("FILE", "FLASH", "AVAILABLE")
OUT "CARD CAPACITY = ";GETSETTING$("FILE", "CARD", "CAPACITY")
OUT "CARD AVAILABLE = ";GETSETTING$("FILE", "CARD", "AVAILABLE")
OUT "CARD INSTALLED = ";GETSETTING$("FILE", "CARD", "INSTALLED")
OUT "Ethernet MAC ADDRESS = ";GETSETTING$("CONFIG", "NET", "MAC ADDRESS")
OUT "Ethernet IP ADDRESS = ";GETSETTING$("CONFIG", "NET", "IP ADDRESS")
OUT "Ethernet SUBNET MASK = ";GETSETTING$("CONFIG", "NET", "SUBNET MASK")
OUT "Ethernet DEFAULT GATEWAY = ";GETSETTING$("CONFIG", "NET", "DEFAULT GATEWAY")
OUT "Ethernet PRIMARY DNS = ";GETSETTING$("CONFIG", "NET", "PRIMARY DNS")
OUT "Ethernet SECONDARY DNS = ";GETSETTING$("CONFIG", "NET", "SECONDARY DNS")
OUT "COM1 BAUD RATE = ";GETSETTING$("CONFIG", "COM1", "BAUD RATE")
OUT "COM1 DATA BIT = ";GETSETTING$("CONFIG","COM1","DATA BIT")
OUT "COM1 PARITY = ";GETSETTING$("CONFIG", "COM1", "PARITY")
OUT "COM1 STOP BIT = ";GETSETTING$("CONFIG", "COM1", "STOP BIT")
OUT "SENSOR TYPE = ";GETSETTING$("CONFIG","SENSOR","SENSOR TYPE")
OUT "CARRIAGE = ";GETSETTING$("CONFIG", "SENSOR", "CARRIAGE")
OUT "GAP INTENSION = ";GETSETTING$("CONFIG","SENSOR","GAP INTENSION")
OUT "BLINE INTENSION = ";GETSETTING$("CONFIG", "SENSOR", "BLINE INTENSION")
OUT "CONTINUOUS INTENSION = ";GETSETTING$("CONFIG","SENSOR","CONTINUOUS INTENSION")
OUT "PRINT MODE = ";GETSETTING$("CONFIG", "TSPL", "PRINT MODE")
OUT "DENSITY = ";GETSETTING$("CONFIG","TSPL","DENSITY")
OUT "PAPER SIZE = ";GETSETTING$("CONFIG", "TSPL", "PAPER SIZE")
OUT "GAP SIZE = ";GETSETTING$("CONFIG", "TSPL", "GAP SIZE")
OUT "BLINE SIZE = ";GETSETTING$("CONFIG", "TSPL", "BLINE SIZE")
OUT "DIRECTION = ";GETSETTING$("CONFIG","TSPL","DIRECTION")
OUT "MIRROR = ";GETSETTING$("CONFIG","TSPL","MIRROR")
OUT "RIBBON = ";GETSETTING$("CONFIG", "TSPL", "RIBBON")
OUT "REPRINT = ";GETSETTING$("CONFIG", "TSPL", "REPRINT")
OUT "PAPER WIDTH = ";GETSETTING$("CONFIG", "TSPL", "PAPER WIDTH")
OUT "LIMIT FEED = ";GETSETTING$("CONFIG", "TSPL", "LIMIT FEED")
OUT "OFFSET = ";GETSETTING$("CONFIG", "TSPL", "OFFSET")
OUT "REFERENCE X = ";GETSETTING$("CONFIG", "TSPL", "REFERENCE X")
OUT "REFERENCE Y = ";GETSETTING$("CONFIG", "TSPL", "REFERENCE Y")
OUT "SHIFT X = ";GETSETTING$("CONFIG", "TSPL", "SHIFT X")
OUT "SHIFT Y = ";GETSETTING$("CONFIG", "TSPL", "SHIFT Y")
OUT "SPEED = ";GETSETTING$("CONFIG", "TSPL", "SPEED")

```

OUT "COUNTRY CODE = ";GETSETTING\$("CONFIG","TSPL","COUNTRY CODE")  
 OUT "CODEPAGE = ";GETSETTING\$("CONFIG","TSPL","CODEPAGE")

## Result

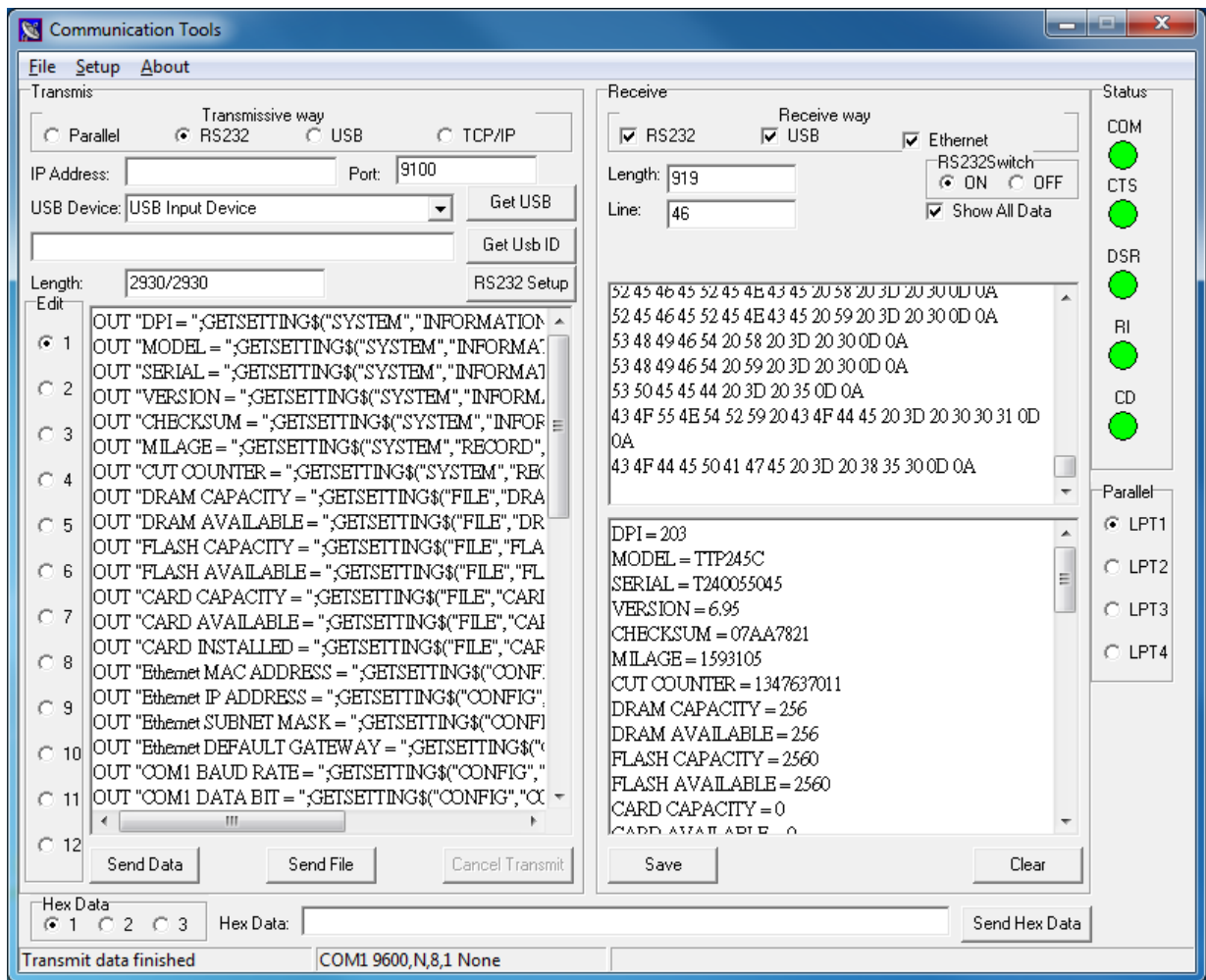

## Sample code(NET, WLAN)

OUT "Ethernet DEFAULT RAW PORT = ";GETSETTING\$("CONFIG","NET","RAW PORT")

OUT "WLAN MAC ADDRESS = ";GETSETTING\$("CONFIG","WLAN","MAC ADDRESS")

OUT "WLAN IP ADDRESS = ";GETSETTING\$("CONFIG","WLAN","IP ADDRESS")

OUT "WLAN SUBNET MASK = ";GETSETTING\$("CONFIG","WLAN","SUBNET MASK")

OUT "WLAN DEFAULT GATEWAY = ";GETSETTING\$("CONFIG","WLAN","DEFAULT GATEWAY")

OUT "WLAN DEFAULT RAW PORT = ";GETSETTING\$("CONFIG","WLAN","RAW PORT")

OUT "NET Name = ";GETSETTING\$("CONFIG","NET","NAME")

## ● SET USBHOST

### Description

This command can set the USB host for the usage of USB keyboard or scanner.

### Syntax

**SET USBHOST KEYBOARD/SCANNER**

| <u>Parameter</u> | <u>Description</u>                            |
|------------------|---|
| KEYBOARD         | USB keyboard (Enable the prompt shown on LCD) |
| SCANNER          | USB scanner (Disable the prompt shown on LCD) |

**Note:**

- *This command has been supported since V6.95 EZ and later firmware.*
- *This command is for the model which has USB HOST connector.*

### Example

#### Sample code

```
SET USBHOST KEYBOARD
DOWNLOAD "A.BAS "
LOOP:
SIZE 4,2
GAP 0,0
CLS
INPUT A$
TEXT 50,50, "0 ",0,20,20,A$
PRINT 1
GOTO LOOP
EOP
A.BAS
```

## ● SET RS232\_REWINDER

### Description

This command is used to set the CTS (PIN8) control signal to High or Low status via RS-232 port for external rewind module application.

### Syntax

**SET RS232\_REWINDER "RASING"/ "FALLING"/ "OFF"**

| Parameter | Description  |
|-----------|--|
| "RASING"  | Set high level signal status while printer is printing |
| "FALLING" | Set low level signal status while printer is printing  |
| "OFF "    | Disable this function (Default)                        |

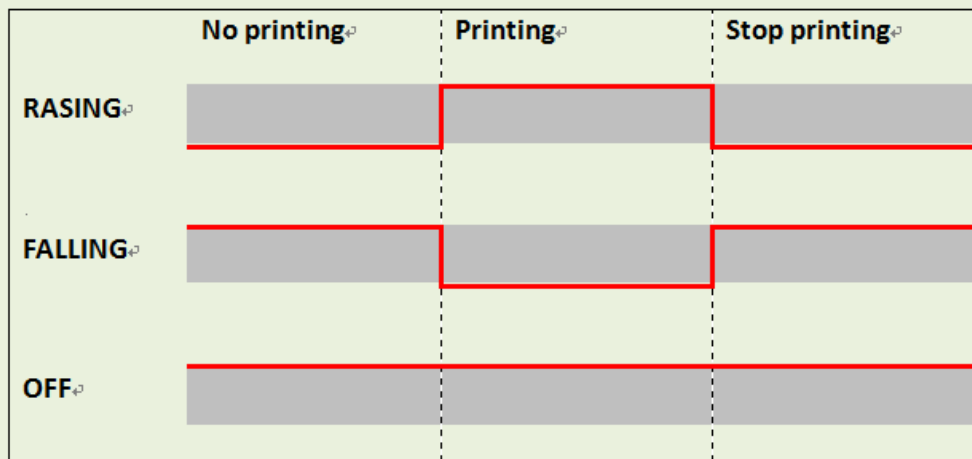

#### Note:

- This command has been supported since V8.04 EZ and later firmware. For Ax.xx firmware, please refer to "SET REWIND" command.
- This command is for the model which has RS-232 connector.

### Example

#### Sample code

```
SET RS232_REWINDER "RASING"
```

## ● SET AUTORUN

### Description

This command redefines the BAS file which can be run automatically while switching on the printer. Default is AUTO.BAS.

### Syntax

SET AUTORUN "filename"

| <u>Parameter</u> | <u>Description</u>  |
|------------------|---|
| filename         | The file will be defined to AUTO-RUN file. Default is AUTO.BAS. |

**Note:**  
*This command has been supported since V6.86 EZ and later firmware.*

### Example

| <u>Sample Code</u>   |
|--|
| <pre>REM *****Step1: Send the following command to redefine the auto-run file from "AUTO.BAS" to "TEST.BAS" SET AUTORUN "TEST.BAS"  REM *****Step2: Send the following commands to download "TEST.BAS" file into printer. DOWNLOAD F, "TEST.BAS" SIZE 4,1 GAP 0,0 DIRECTION 1 CLS BLOCK 10,10,600,200, "3",0,1,1,12, "[ ]TEST.BAS\[ ] is running automatically while turning on the printer. " PRINT 1 EOP  REM *****Step3: Turn off and on the printer to run "TEST.BAS" automatically.</pre> |
| <u>Result</u>  |
| <pre>"TEST.BAS" is running automatically while turning on the printer.</pre>   |

## ● SET VERIFIER

### Description

This command is used to add a data at start printing or end printing then return it via RS-232 port for verifier (scanner) application.

### Syntax

**SET VERIFIER ON/OFF**  
**VERIFYTRIGGER CHR\$( )+CHR\$( )...**  
**VERIFYEND CHR\$( )+CHR\$( )...**

| Parameter     | Description                |
|---------------|----------------------------|
| ON            | Enable verifier function   |
| OFF           | Disable verifier function  |
| VERIFYTRIGGER | Add data at start printing |
| VERIFYEND     | Add data at end printing   |

**Note:**  
*This command has been supported since V6.92 EZ and later firmware.*

### Example

#### Sample Code

```
SET VERIFIER ON
VERIFYTRIGGER CHR$(48)+CHR$(49)+CHR$(50)
VERIFYEND CHR$(65)+CHR$(66)+CHR$(67)
PRINT 10
```

#### Result

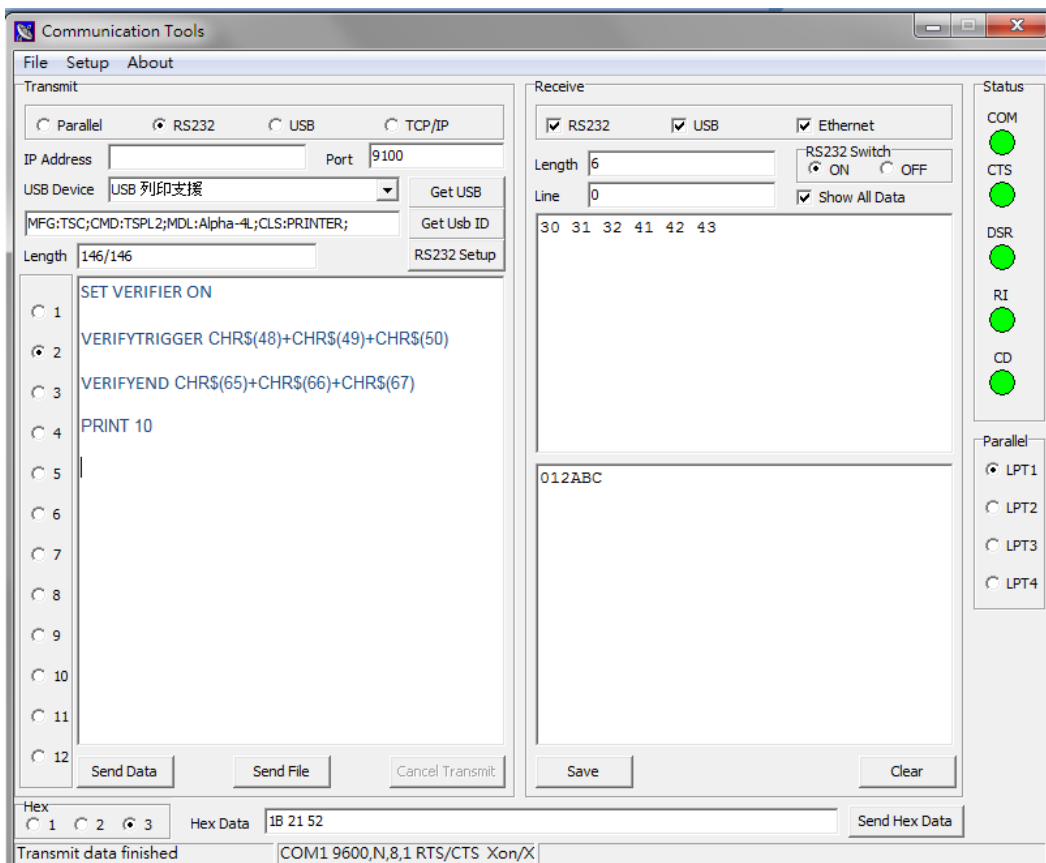

## ● SET RESPONSE

### Description

This command can response issue automatically.

### Syntax

**SET RESPONSE ["Job ID",] ON/OFF/BATCH**

| <u>Parameter</u> | <u>Description</u>                    |
|------------------|---------------------------------------|
| ["Job ID"]       | Optional. Set job ID. Default is Null |
| ON               | Enable this function                  |
| OFF              | Disable this function. Default is OFF |
| BATCH            | Response at the end of printing job   |

**Note:**  
*This command has been supported since V7.09 EZ and later firmware.*

### Response Syntax

**{Status,#####,ID}**

| <u>Status</u>                                  |
|--|
| [Hex Receive]                                  |
| 00 Normal                                      |
| 01 Head opened                                 |
| 02 Paper Jam                                   |
| 03 Paper Jam and head opened                   |
| 04 Out of paper                                |
| 05 Out of paper and head opened                |
| 08 Out of ribbon                               |
| 09 Out of ribbon and head opened               |
| 0A Out of ribbon and paper jam                 |
| 0B Out of ribbon, paper jam and head opened    |
| 0C Out of ribbon and out of paper              |
| 0D Out of ribbon, out of paper and head opened |
| 10 Pause                                       |
| 20 Printing                                    |
| 80 Other error                                 |
| #####: 00001 ~ 99999                           |

### Example

| <u>Sample Code</u>  |
|---|
| <pre>SET RESPONSE ON SIZE 4,2 GAP 0,0 PRINT 3  {00,00001}{00,00002}{00,00003}</pre> |

**Sample Code**

SET RESPONSE "ID1",ON  
SIZE 4,2  
GAP 0,0  
PRINT 3,2

{00,00001,ID1}{00,00002,ID1}{00,00003,ID1}{00,00004,ID1}{00,00005,ID1}{00,00006,ID1}

**Sample Code**

SET RESPONSE "CCCC ",BATCH  
SIZE 4,2  
GAP 0,0  
PRINT 3,2

{00,00006,CCCC}



## ● SET DAYLIGHT\_SAVE

### Description

This command is used to set daylight saving time.

### Syntax

SET DAYLIGHT\_SAVE ON/OFF

SET DAYLIGHT\_SAVE "Start", "End"

| <u>Paramet</u> | <u>Description</u>  |
|----------------|---|
| <u>er</u>      |   |
| ON             | Enable function   |
| OFF            | Disable function (Default)  |
| "Start"        | The time will be increased 1 hour from "Start time"   |
| "End"          | The time will be reduced 1 hour (return) from "End time"  |
|                | <b>Month</b>  |
|                | "JAN", "FEB", "MAR", "APR", "MAY", "JUN", "JUL", "AUG", "SEP", "OCT", "NOV", "DEC"<br>"JANUARY", "FEBRUARY", "MARCH", "APRIL", "MAY", "JUNE", "JULY", "AUGUST", "SEPTEMBER",<br>"OCTOBER", "NOVEMBER", "DECEMBER" |
|                | <b>Week</b>   |
|                | "SUN", "MON", "TUE", "WED", "THU", "FRI", "SAT"<br>"SUNDAY", "MONDAY", "TUESDAY", "WEDNESDAY", "THURSDAY", "FRIDAY", "SATURDAY"   |
|                | <b>Which Week</b>   |
|                | "FIRST", "SECOND", "THIRD", "FOURTH", "LAST"<br>"1 <sup>ST</sup> ", "2 <sup>ND</sup> ", "3 <sup>RD</sup> ", "4 <sup>TH</sup> ", "LAST"  |
|                | <b>Date</b>   |
|                | 1~31  |
|                | <b>Time</b>   |
|                | 0:00~23:00  |
| <b>Note:</b>   | <i>This command has been supported since V8.03 EZ and later firmware.</i>   |

### Example

#### Sample Code

```
SET DAYLIGHT_SAVE ON
SET DAYLIGHT_SAVE OFF
SET DAYLIGHT_SAVE "MAR 1 4:00", "NOV 1 5:00"
SET DAYLIGHT_SAVE "MAR FIRST SUN 2:00", "NOV LAST SUN 3:00"
```

## ● PEEL

### Description

This command obtains the status of the peel-off sensor. This attribute is read only.

### Syntax

PEEL

| <u>Return Value</u> | <u>Description</u>                 |
|---------------------|------------------------------------|
| 0                   | Paper is not on top of peel sensor |
| 1                   | Paper is on top of peel sensor     |

### Example

#### Sample code

```
DOWNLOAD "DEMO.BAS"
SIZE 4,1
GAP 0,0
SET PEEL OFF
SET KEY1 OFF
SET LED1 OFF
SET LED3 OFF
:START
LED1=0
LED3=0
IF KEY1=1 THEN GOTO A
GOTO START
:A
LED1=1
CLS
TEXT 10,10, "3",0,1,1, "PEEL Function Test!! "
PRINT 1,1
:B
LED1=0
IF PEEL=1 THEN
LED3=1
GOTO B
ELSE
CLS
TEXT 10,10, "3",0,1,1, "The label is removed from the PEEL sensor!! "
PRINT 1,1
GOTO START
ENDIF
EOP
DEMO
```

## ● LED1, LED2, LED3

### Description

This command is used to control LED on/off. This attribute is write-only. Specify 1 to light on LED and 0 to turn off LED. Before using this command, be sure to cancel the default LED functions. Please refer to the SET LED command.

### Syntax

**LEDm = n**

| <u>Return Value</u> | <u>Description</u>                  |
|---------------------|-------------------------------------|
| m                   | m=1, LED1<br>m=2, LED2<br>m=3, LED3 |
| n                   | 0: turn off LED<br>1: light on LED  |

| Model  | LED1   | LED2   | LED3  | LED4 | LED5 | LED6    | LED7 | LED2 & LED3 |
|--|--------|--------|-------|------|------|---------|------|-------------|
| TDP-643 Plus/ 643R Plus series   | ONLINE | ERROR  | ERROR |      |      |         |      |             |
| TTP-243/243 Plus/243 Pro series,<br>TTP-244ME/244 ME Plus/244M Pro series,<br>TTP-244/ 244 Plus series<br>TTP-2410M/2410M Pro series,<br>TTP-246M Plus/246M Pro series,<br>TTP-268M series, TTP-384M series,<br>ME240 series, MX240 series,<br>MX240P series | POWER  | ONLINE | ERROR |      |      |         |      |             |
| TDP-245/247 series, TTP-245/247 series,<br>TTP-245C series, TDP-225 series,<br>TTP-225 series, DA200 series,<br>TA200 series, TC210series, TE200 series,<br>MH series<br><b>Note: For this series, the LED1=LED2</b>   | GREEN  | GREEN  | RED   |      |      |         |      | ORANGE      |
| Alpha-2R series , Alpha-3R series  | GREEN  | RED    | BAT1  | BAT2 | BAT3 | BT/WIFI |      | ORANGE      |
| Alpha-4L series  | GREEN  | RED    | BAT1  | BAT2 | BAT3 | BT      | WIFI | ORANGE      |

**Note:** Please refer to [printer model list](#) for checking series printers.

### Example

```

Sample code
DOWNLOAD "DEMO.BAS"
SIZE 3,3
GAP 0.12,0
SPEED 4
DENSITY 8
DIRECTION 1
REFERENCE 0,0
SET CUTTER OFF
SET PEEL OFF
SET LED1 OFF
SET LED2 OFF
SET LED3 OFF
LED1=0
LED2=1
LED3=0
EOP

```

**DEMO**

## ● KEY1, KEY2, KEY3

### Description

This command reads the status of KEY1, KEY2 and KEY3.

| Model   | KEY0 | KEY1  | KEY2  | KEY3  | KEY4  | KEY5   | KEY6     |
|---|------|-------|-------|-------|-------|--------|----------|
| TDP-643 Plus/ 643R Plus   |      | PAUSE |       |       |       |        |          |
| TTP-243/243 Plus/243 Pro series, TTP-244ME/244 ME Plus/244M Pro series, TTP-244/244 Plus series   |      | PAUSE | FEED  |       |       |        |          |
| TDP-245/247 series, TTP-245/247 series, TTP-245C series, TDP-225 series, TTP-225 series, TA200 series, Alpha-3R, DA series, TE series, Alpha-2R |      | FEED  |       |       |       |        |          |
| TX200 series (with LCD), TC210 series (with LCD), TX600 series, MX240P series, MH series  |      | FEED  | MENU  | UP    | RIGHT | LEFT   | DOWN     |
| TTP-246M series   |      | MENU  | PAUSE | FEED  | (UP)  | (DOWN) | (SELECT) |
| TTP-248M series   |      | MENU  | PAUSE | FEED  |       |        |          |
| TTP-2410M/2410M Pro series, TTP-246M Plus/246M Pro series, TTP-268M series, TTP-384M series, ME240(LCD control panel) series                    |      | MENU  | PAUSE | FEED  | UP    | DOWN   | SELECT   |
| ME240 (Non-LCD control panel) series  |      | FEED  | PAUSE |       |       |        |          |
| M23 series  | FEED | LEFT  | MID   | RIGHT |       |        |          |
| Alpha-4L  |      | FEED  | INFO  | MENU  |       |        |          |
| MX240 series, TTP-2410MT/MU series  |      | PAUSE | MENU  | FEED  | UP    | SELECT | DOWN     |

Note: Please refer to [printer model list](#) for checking series printers.

### Syntax

**KEYm = n**

| Key          | Return Value              |
|--------------|---------------------------|
| KEY1 (MENU)  | 0: released<br>1: pressed |
| KEY2 (PAUDE) | 0: released<br>1: pressed |
| KEY3 (FEED)  | 0: released<br>1: pressed |

### Example

```

Sample code

DOWNLOAD "DEMO.BAS"
SIZE 3,1
GAP 0,0
SPEED 4
DENSITY 8
DIRECTION 1
REFERENCE 0,0

```

```
SET LED1 OFF
SET KEY1 OFF
LED1=0
:START
IF KEY1=1 THEN
LED1=1
CLS
TEXT 100,10, "3",0,1,1, "KEY FUNCTION TEST"
PRINT 1,1
ELSE
LED1=0
ENDIF
GOTO START
EOP
DEMO
```

# Printer Global Variables

## ● @LABEL

### Description

This variable counts how many pieces of labels have been printed. This attribute cannot be initialized if the printer is reset, but will be retained if the printer power is turned off.

### Syntax

Write attribute: @LABEL=n or @LABEL= "n"

Read attribute: A=LABEL or A\$=STR\$(LABEL)

| <u>Parameter</u> | <u>Description</u>                        |
|------------------|---|
| n                | Number of labels printed. 0<=n<=999999999 |

### Example

| <u>Sample code</u>  | <u>Result</u>  |
|---|--|
| <pre>DOWNLOAD "DEMO.BAS" SIZE 4,2.5 GAP 0,0 DIRECTION 1 CLS TEXT 10,50, "3",0,1,1,@LABEL TEXT 10,100, "3",0,1,1, "@LABEL="+STR\$(LABEL) TEXT 10,150, "3",0,1,1, "*****Statement 1*****" IF LABEL&gt;1000 THEN TEXT 10,200, "3",0,1,1, "LABEL&gt;1000" ELSE TEXT 10,200, "3",0,1,1, "LABEL&lt;1000" ENDIF TEXT 10,250, "3",0,1,1, "*****Statement 1*****" A=LABEL IF A&gt;1000 THEN TEXT 10,300, "3",0,1,1, "A&gt;1000" ELSE TEXT 10,300, "3",0,1,1, "A&lt;1000" ENDIF TEXT 10,350, "3",0,1,1, "*****Statement 3*****" A\$=STR\$(LABEL) IF VAL(A\$)&gt;1000 THEN TEXT 10,400, "3",0,1,1, "VAL(A\$)&gt;1000" ELSE TEXT 10,400, "3",0,1,1, "VAL(A\$)&lt;1000" ENDIF PRINT 1,1 EOP DEMO</pre> | <pre>1661 @LABEL=1661 *****Statement 1***** LABEL&gt;1000 *****Statement 1***** A&gt;1000 *****Statement 3***** VAL(A\$)&gt;1000</pre> |

## ● YEAR

### Description

This variable reads/writes the year data via the Real Time Clock (RTC). Four-digit year formats are supported by RTC.

### Syntax

Write attribute: YEAR = 02

Read attribute: A = YEAR

Range: 00~50 = 2000~2050; 51~99 = 1951~1999

### Example

#### Sample code

```
DOWNLOAD "SetYear.BAS"
REM *****Set Year Parameter to RTC*****
YEAR=13
EOP
SetYear
```

#### Sample code

```
DOWNLOAD "DEMO.BAS"
SIZE 4,1
GAP 0,0
DIRECTION 1
CLS

REM *****Read YEAR parameter from RTC*****
YEAR$=STR$(YEAR)
Y=YEAR

REM *****Print*****
TEXT 10,10, "3",0,1,1, "YEAR1="+YEAR$
TEXT 10,50, "3",0,1,1, "YEAR2="+STR$(Y)
TEXT 10,90, "3",0,1,1, "YEAR3="+STR$(YEAR)
PRINT 1
EOP
DEMO
```

#### Result

```
YEAR1=2013
YEAR2=2013
YEAR3=2013
```

### See Also

~!C, MONTH, DATE, DAY, HOUR, MINUTE, SECOND



## ● MONTH

### Description

This variable reads/writes the month data via the Real Time Clock (RTC). Two-digit (01~12) month formats are supported by RTC.

### Syntax

Write attribute: MONTH = 01

Read attribute: A = MONTH

Range: 01~12

### Example

#### Sample code

```
DOWNLOAD "SetMonth.BAS"  
REM *****Set Month Parameter to RTC*****  
MONTH=01  
EOP  
SetMonth
```

#### Sample code

```
DOWNLOAD "DEMO.BAS"  
SIZE 4,1  
GAP 0,0  
DIRECTION 1  
CLS  
  
REM *****Read Month parameter form RTC*****  
MONTH$=STR$(MONTH)  
M=MONTH  
  
REM *****Print*****  
TEXT 10,10, "3",0,1,1, "MONTH1="+MONTH$  
TEXT 10,50, "3",0,1,1, "MONTH2="+STR$(M)  
TEXT 10,90, "3",0,1,1, "MONTH3="+STR$(MONTH)  
PRINT 1  
EOP  
DEMO
```

#### Result

```
MONTH1=1  
MONTH2=1  
MONTH3=1
```

### See Also

~!C, MONTH, DATE, DAY, HOUR, MINUTE, SECOND

## ● DATE

### Description

This variable reads/writes the date data via the Real Time Clock (RTC). Two-digit (01~31) date formats are supported by RTC.

### Syntax

Write attribute: DATE = 12

Read attribute: A = DATE

Range: 01~31

### Example

#### Sample code

```
DOWNLOAD "SetDate.BAS"
REM *****Set Date Parameter to RTC*****
DATE=10
EOP
SetDate
```

#### Sample code

```
DOWNLOAD "DEMO.BAS"
SIZE 4,1
GAP 0,0
DIRECTION 1
CLS

REM *****Read Date parameter form RTC*****
DATE$=STR$(DATE)
D=DATE

REM *****Print*****
TEXT 10,10, "3",0,1,1, "DATE1="+DATE$
TEXT 10,50, "3",0,1,1, "DATE2="+STR$(D)
TEXT 10,90, "3",0,1,1, "DATE3="+STR$(DATE)
PRINT 1
EOP
DEMO
```

#### Result

```
DATE1=10
DATE2=10
DATE3=10
```

### See Also

~!C, MONTH, DATE, DAY, HOUR, MINUTE, SECOND

## ● WEEK

### Description

This variable reads/writes the day of the week data via the Real Time Clock (RTC), which is represented by one single digit (1~7).

### Syntax

**Read attribute: A = WEEK**

Range: 1(Sunday)~7(Saturday)

### Example

#### Sample code

```
DOWNLOAD "DEMO.BAS "  
SIZE 4,1  
GAP 0,0  
DIRECTION 1  
CLS  
  
REM *****Read Week parameter form RTC*****  
WEEK$=STR$(WEEK)  
W=WEEK  
  
REM *****Print*****  
TEXT 10,10, "3",0,1,1, "WEEK1="+WEEK$  
TEXT 10,50, "3",0,1,1, "WEEK2="+STR$(W)  
TEXT 10,90, "3",0,1,1, "WEEK3="+STR$(WEEK)  
PRINT 1  
EOP  
DEMO
```

#### Result

```
WEEK1=5  
WEEK2=5  
WEEK3=5
```

### See Also

~!C, MONTH, DATE, DAY, HOUR, MINUTE, SECOND

## ● HOUR

### Description

This variable reads/writes the hour data via the Real Time Clock (RTC). The 24-hour-day system (00~23) is supported by RTC.

### Syntax

Write attribute: HOUR = 12

Read attribute: A = HOUR

Range: 00~23

### Example

#### Sample code

```
DOWNLOAD "SetHour.BAS"  
REM *****Set Hour Parameter to RTC*****  
HOUR=10  
EOP  
SetHour
```

#### Sample code

```
DOWNLOAD "DEMO.BAS"  
SIZE 4,1  
GAP 0,0  
DIRECTION 1  
CLS  
  
REM *****Read Hour parameter form RTC*****  
HOUR$=STR$(HOUR)  
H=HOUR  
  
REM *****Print*****  
TEXT 10,10, "3",0,1,1, "HOUR1="+HOUR$  
TEXT 10,50, "3",0,1,1, "HOUR2="+STR$(H)  
TEXT 10,90, "3",0,1,1, "HOUR3="+STR$(HOUR)  
PRINT 1  
EOP  
DEMO
```

#### Result

```
HOUR1=10  
HOUR2=10  
HOUR3=10
```

### See Also

~!C, MONTH, DATE, DAY, HOUR, MINUTE, SECOND

## ● MINUTE

### Description

This variable reads/writes the minute data via the Real Time Clock (RTC). Two-digits (00~59) minute format is supported by RTC.

### Syntax

Write attribute: MINUTE = 12

Read attribute: A = MINUTE

Range: 00~59

### Example

#### Sample code

```
DOWNLOAD "SetMinute.BAS"  
REM *****Set Minute Parameter to RTC*****  
MINUTE=27  
EOP  
SetMinute
```

#### Sample code

```
DOWNLOAD "DEMO.BAS"  
SIZE 4,1  
GAP 0,0  
DIRECTION 1  
CLS  
  
REM *****Read Minute parameter form RTC*****  
MINUTE$=STR$(MINUTE)  
MIN=MINUTE  
  
REM *****Print*****  
TEXT 10,10, "3",0,1,1, "MINUTE1="+MINUTE$  
TEXT 10,50, "3",0,1,1, "MINUTE2="+STR$(MIN)  
TEXT 10,90, "3",0,1,1, "MINUTE3="+STR$(MINUTE)  
PRINT 1  
EOP  
DEMO
```

#### Result

```
MINUTE1=27  
MINUTE2=27  
MINUTE3=27
```

### See Also

~!C, MONTH, DATE, DAY, HOUR, MINUTE, SECOND

## ● SECOND

### Description

This variable reads/writes the second data via the Real Time Clock (RTC). Two-digits (00~59) second format is supported by RTC.

### Syntax

Write attribute: **SECOND = 12**

Read attribute: **A = SECOND**

Range: 00~59

### Example

#### Sample code

```
DOWNLOAD "SetSecond.BAS"  
REM *****Set Second Parameter to RTC*****  
SECOND=59  
EOP  
SetSecond
```

#### Sample code

```
DOWNLOAD "DEMO.BAS "  
SIZE 4,1  
GAP 0,0  
DIRECTION 1  
CLS  
  
REM *****Read Second parameter form RTC*****  
SECOND$=STR$(SECOND)  
SEC=SECOND  
  
REM *****Print*****  
TEXT 10,10, "3",0,1,1, "SECOND1="+SECOND$  
TEXT 10,50, "3",0,1,1, "SECOND2="+STR$(SEC)  
TEXT 10,90, "3",0,1,1, "SECOND3="+STR$(SECOND)  
PRINT 1  
EOP  
DEMO
```

#### Result

```
SECOND1=59  
SECOND2=59  
SECOND3=59
```

### See Also

~!C, MONTH, DATE, DAY, HOUR, MINUTE, SECOND

## ● @YEAR

### Description

This variable reads/writes the year data via the Real Time Clock (RTC). Two-digit year formats are supported by RTC. @YEAR global variable can be accessed directly without using BASIC language functions.

### Syntax

Write attribute: @YEAR = "01"

Read attribute: @YEAR

Range: 00~99

Note: This command is only available for TSPL2 printers. Please refer to [printer model list](#) for checking TSPL2 printers.

### Example

| Sample code  | Result                     |
|--|----------------------------|
| <pre>REM *****Set @YEAR***** @YEAR="05"  REM *****Print***** SIZE 4,1 GAP 0,0 DIRECTION 1 CLS TEXT 10,10, "3",0,1,1, "@YEAR" TEXT 210,10, "3",0,1,1, @YEAR PRINT 1</pre> | <pre>@YEAR      2005</pre> |

### See Also

~!C, @MONTH, @DATE, @DAY, @HOUR, @MINUTE, @SECOND

## ● @MONTH

### Description

This variable reads/writes the month data via the Real Time Clock (RTC). Two-digits (01~12) month formats are supported by RTC. @MONTH global variable can be accessed directly without using BASIC language functions.

### Syntax

Write attribute: @MONTH = "01"

Read attribute: @MONTH

Range: 01~12

Note: This command is only available for TSPL2 printers. Please refer to [printer model list](#) for checking TSPL2 printers.

### Example

| Sample code   | Result                    |
|---|---------------------------|
| <pre>REM *****Set @MONTH***** @MONTH="12"  REM *****Print***** SIZE 4,1 GAP 0,0 DIRECTION 1 CLS TEXT 10,10, "3",0,1,1, "@MONTH" TEXT 210,10, "3",0,1,1,@MONTH PRINT 1</pre> | <pre>@MONTH      12</pre> |

### See Also

~!C, @YEAR, @DATE, @DAY, @HOUR, @MINUTE, @SECOND



## ● @DATE

### Description

This variable reads/writes the date data via the Real Time Clock (RTC). Two-digits (01~31) date formats are supported by RTC. @DATE global variable can be accessed directly without using BASIC language functions.

### Syntax

Write attribute: @DATE = "12"

Read attribute: @DATE

Range: 01~31

Note: This command is only available for TSPL2 printers. Please refer to [printer model list](#) for checking TSPL2 printers.

### Example

| Sample code   | Result                   |
|---|--------------------------|
| <pre>REM *****Set @DATE***** @DATE="31"  REM *****Print***** SIZE 4,1 GAP 0,0 DIRECTION 1 CLS TEXT 10,10, "3",0,1,1, "@DATE" TEXT 210,10, "3",0,1,1,@DATE PRINT 1</pre> | <pre>@DATE      31</pre> |

### See Also

~!C, @YEAR, @MONTH, @DAY, @HOUR, @MINUTE, @SECOND

## ● @DAY

### Description

This variable reads/writes the day of the week data via the Real Time Clock (RTC), which is represented by one single digit (1~7). @DAY global variable can be accessed directly without using BASIC language functions.

### Syntax

**Read attribute:** @DAY

Range: 1(Sunday)~7(Saturday)

**Note:** This command is only available for TSPL2 printers. Please refer to [printer model list](#) for checking TSPL2 printers.

### Example

| Sample code   | Result                 |
|---|------------------------|
| <pre>REM *****Print***** SIZE 4,1 GAP 0,0 DIRECTION 1 CLS TEXT 10,10, "3",0,1,1, "@DAY" TEXT 210,10, "3",0,1,1,@DAY PRINT 1</pre> | <pre>@DAY      7</pre> |

### See Also

~!C, @YEAR, @MONTH, @DATE, @HOUR, @MINUTE, @SECOND

## ● @HOUR

### Description

This variable reads/writes the hour data via the Real Time Clock (RTC). The 24-hour-day system (00~23) is supported by RTC. @HOUR global variable can be accessed directly without using BASIC language functions.

### Syntax

Write attribute: @HOUR = "12"

Read attribute: @HOUR

Range: 00~23

Note: This command is only available for TSPL2 printers. Please refer to [printer model list](#) for checking TSPL2 printers.

### Example

| Sample code   | Result                   |
|---|--------------------------|
| <pre>REM *****Set @HOUR***** @HOUR="23"  REM *****Print***** SIZE 4,1 GAP 0,0 DIRECTION 1 CLS TEXT 10,10, "3",0,1,1, "@HOUR" TEXT 210,10, "3",0,1,1,@HOUR PRINT 1</pre> | <pre>@HOUR      23</pre> |

### See Also

~!C, @YEAR, @MONTH, @DATE, @DAY, @MINUTE, @SECOND

## ● @MINUTE

### Description

This variable reads/writes the minute data via the Real Time Clock (RTC). The two-digits (00~59) minute format is supported by RTC. @MINUTE global variable can be accessed directly without using BASIC language functions.

### Syntax

Write attribute: @MINUTE = "12"

Read attribute: @MINUTE

Range: 00~59

Note: This command is only available for TSPL2 printers. Please refer to [printer model list](#) for checking TSPL2 printers.

### Example

| Sample code   | Result                     |
|---|----------------------------|
| <pre>REM *****Set @MINUTE***** @MINUTE="59"  REM *****Print***** SIZE 4,1 GAP 0,0 DIRECTION 1 CLS TEXT 10,10, "3",0,1,1, "@MINUTE" TEXT 210,10, "3",0,1,1,@MINUTE PRINT 1</pre> | <pre>@MINUTE      59</pre> |

### See Also

~!C, @YEAR, @MONTH, @DATE, @DAY, @HOUR, @SECOND

## ● @SECOND

### Description

This variable reads/writes the second data via the Real Time Clock (RTC). The Two-digit (00~59) second format is supported by RTC. @SECOND global variable can be accessed directly without using BASIC language functions.

### Syntax

Write attribute: @SECOND = "12"

Read attribute: @SECOND

Range: 00~59

Note: This command is only available for TSPL2 printers. Please refer to [printer model list](#) for checking TSPL2 printers.

### Example

| Sample code   | Result                     |
|---|----------------------------|
| <pre>REM *****Set @SECOND***** @SECOND = "59"  REM *****Print***** SIZE 4,1 GAP 0,0 DIRECTION 1 CLS TEXT 10,10, "3",0,1,1, "@SECOND" TEXT 210,10, "3",0,1,1,@SECOND PRINT 1</pre> | <pre>@SECOND      59</pre> |

### See Also

~!C, @YEAR, @MONTH, @DATE, @DAY, @HOUR, @MINUTE

## ● **\_MODEL\$**

### **Description**

This variable can be read only. It includes the information of printer's model name.

### **Syntax**

**\_MODEL\$**

### **Example**

#### **Sample code**

```
SIZE 4,1  
GAP 0,0  
DIRECTION 1  
CLS  
TEXT 10,10, "3",0,1,1, "Model: " + _MODEL$  
TEXT 10,60, "3",0,1,1, "Serial No.: " + _SERIAL$  
TEXT 10,110, "3",0,1,1, "F/W Version: " + _VERSION$  
PRINT 1
```

#### **Result**

```
Model: TDP247  
Serial No.: D452350388  
F/W Version: 7.00
```

### **See Also**

**\_SERIAL\$, \_VERSION\$**

## ● **\_SERIAL\$**

### **Description**

This variable can be read only. It includes the information of printer's serial number.

*\*The printer's serial number must be programmed into printer at factory.*

### **Syntax**

**\_SERIAL\$**

### **Example**

#### **Sample code**

```
SIZE 4,1  
GAP 0,0  
DIRECTION 1  
CLS  
TEXT 10,10, "3",0,1,1, "Model: " + _MODEL$  
TEXT 10,60, "3",0,1,1, "Serial No.: " + _SERIAL$  
TEXT 10,110, "3",0,1,1, "F/W Version: " + _VERSION$  
PRINT 1
```

#### **Result**

```
Model: TDP247  
Serial No.: D452350388  
F/W Version: 7.00
```

### **See Also**

**\_MODEL\$, \_VERSION\$**

## ● **\_VERSION\$**

### **Description**

This variable can be read only. It includes the information of printer's firmware version.

### **Syntax**

**\_SERIAL\$**

### **Example**

#### **Sample code**

```
SIZE 4,1  
GAP 0,0  
DIRECTION 1  
CLS  
TEXT 10,10, "3",0,1,1, "Model: " + _MODEL$  
TEXT 10,60, "3",0,1,1, "Serial No.: " + _SERIAL$  
TEXT 10,110, "3",0,1,1, "F/W Version: " + _VERSION$  
PRINT 1
```

#### **Result**

```
Model: TDP247  
Serial No.: D452350388  
F/W Version: 7.00
```

### **See Also**

**\_MODEL\$, \_VERSION\$**



# Bluetooth Module Setting Commands

## ● BT NAME

### Description

This command is used to set Bluetooth module name. (Max. 15 byte)

### Syntax

**BT NAME "name"**

#### Note:

You can use command SELFTEST BT to check the updated name.

### Example

| Sample code                                 | Result   |
|---|--|
| <pre>BT NAME "TSC001"<br/>SELFTEST BT</pre> | <pre>-----<br/>BT SETTING<br/>-----<br/>MAC ADDR: 000CBF1213C0<br/>NAME: TSC001<br/>PIN CODE: 0000<br/>PRINTER NAME:<br/>PAIR MODE: LEGACY<br/>MODULE: BM78 MFI<br/>MFI SUPPORTED: YES<br/>-----</pre> |

## ● BT PINCODE

### Description

This command is used to set Bluetooth module PIN code. (Max. 15 byte)

### Syntax

**BT PINCODE "pincode"**

#### Note:

You can use command **SELFTEST BT** to check the updated PIN code.

### Example

| Sample code                                  | Result   |
|--|--|
| <pre>BT PINCODE "1234"<br/>SELFTEST BT</pre> | <pre>-----<br/>BT SETTING<br/>-----<br/>MAC ADDR: 000CBF1213C0<br/>NAME: TSC001<br/>PIN CODE: 1234<br/>PRINTER NAME:<br/>PAIR MODE: LEGACY<br/>MODULE: BM78 MFI<br/>MFI SUPPORTED: YES<br/>-----</pre> |

# Wi-Fi Module Setting Commands

## ● WLAN OFF

### Description

This command is used to disable Wi-Fi module. Restart the printer is necessary.

### Syntax

**WLAN OFF**

#### Note:

We can use command **SELFTEST WLAN** to check the status of WLAN. The SSID is empty.

### Example

| Sample code                       | Result   |
|-----------------------------------|--|
| <pre>WLAN OFF SELFTEST WLAN</pre> | <pre>-----                 WLAN SETTING ----- MAC ADDR: 001DC9-908397 MODE: INFRASTRUCTURE SSID: DHCP: OFF IP ADDR: 0.0.0.0  SUBNET: 0.0.0.0 GATEWAY: 0.0.0.0 PORT: 9100 -----</pre> |

### See Also

WLAN SSID

## ● WLAN SSID

### Description

This command is used to set the SSID of your wireless network into Wi-Fi module. Restart the printer is necessary.

### Syntax

**WLAN SSID "ssid"**

| <u>Parameter</u> | <u>Description</u>                       |
|------------------|--|
| ssid             | It is the SSID of your wireless network. |

**Note:**  
*SSID is case-sensitive. The maximum length is 32 bytes.*

### Example

| <u>Sample code</u>                               | <u>Result</u>  |
|--|--|
| <pre>WLAN SSID "TEST-AP"<br/>SELFTEST WLAN</pre> | <pre>-----<br/>                WLAN SETTING<br/>-----<br/>MAC ADDR: 001DC9-908397<br/>  SSID: TEST-AP<br/>  DHCP: OFF<br/> IP ADDR: 0.0.0.0<br/><br/>  SUBNET: 0.0.0.0<br/> GATEWAY: 0.0.0.0<br/>   PORT: 9100<br/>-----</pre> |

### See Also

WLAN OFF

## ● WLAN WPA

### Description

This command is used to set WPA security mode. This command only can be set but not be checked.  
Restart the printer is necessary.

### Syntax

**WLAN WPA OFF**

**WLAN WPA "key"**

| <u>Parameter</u> | <u>Description</u>   |
|------------------|--|
| OFF              | Disable WPA security mode.   |
| Key              | The network security key. 8 to 63 characters.<br>Key = Passphrase or Pre-Shared Key<br>(Passphrase is a string containing between 8 and 63 characters)<br>(Pre-Shared Key is a 32-byte key, formatted as hexadecimal number) |

### Example

#### Sample code

**WLAN WPA OFF**

**WLAN WPA "123456789"**

## ● WLAN WEP

### Description

This command is used to set WEP security mode. This command only can be set but not be checked. Restart the printer is necessary.

### Syntax

**WLAN WEP OFF**

**WLAN WEP n, "key"**

| <u>Parameter</u> | <u>Description</u>   |
|------------------|--|
| OFF              | Disable WEP security mode.   |
| N                | The index of key. 1 to 4.  |
| Key              | The encryption key. 5 or 13 characters or 10 or 26 hexadecimal digits. |

### Example

#### Sample code

```
WLAN WEP OFF
```

```
WLAN WEP 1, "ABCDE"
```

```
WLAN WEP 2, "ABCDE"
```

```
WLAN WEP 3, "ABCDE"
```

```
WLAN WEP 4, "4142434445"
```

## ● WLAN DHCP

### Description

This command is used to set the printer to get the IP address from DHCP server. Restart the printer is necessary.

### Syntax

WLAN DHCP

### Example

| Sample code  | Result  |
|--|---|
| <pre>WLAN SSID "TEST-AP"<br/>WLAN WPA "123456789"<br/>WLAN DHCP<br/>WLAN PORT 9100<br/>SELFTEST WLAN</pre> | <pre>-----<br/>                WLAN SETTING<br/>-----<br/>MAC ADDR: 001DC9-908397<br/>  SSID: TEST-AP<br/>  DHCP: ON<br/>IP ADDR: 10.0.10.138<br/>  SUBNET: 255.255.255.0<br/>GATEWAY: 10.0.10.252<br/>  PORT: 9100<br/>-----</pre> |

### See Also

WLAN IP

## ● WLAN IP

### Description

This command is used to set the specific static IP address to printer. Restart the printer is necessary.

### Syntax

**WLAN IP "ip", "mask", "gateway"**

| <u>Parameter</u> | <u>Description</u> |
|------------------|--------------------|
| ip               | IP address.        |
| Mask             | Subnet mask.       |
| Gateway          | Default gateway.   |

### Example

| <u>Sample code</u>   | <u>Result</u>  |
|--|--|
| <pre>WLAN SSID "TEST-AP"<br/>WLAN WPA "123456789"<br/>WLAN IP "10.0.10.138", "255.255.255.0", "10.0.10.252"<br/>WLAN PORT 9100<br/>SELFTEST WLAN</pre> | <pre>-----<br/>                WLAN SETTING<br/>-----<br/>MAC ADDR: 001DC9-908397<br/>SSID: TEST-AP<br/>DHCP: OFF<br/>IP ADDR: 10.0.10.138<br/>SUBNET: 255.255.255.0<br/>GATEWAY: 10.0.10.252<br/>PORT: 9100<br/>-----</pre> |

### See Also

WLAN DHCP



## ● WLAN PORT

### Description

This command is used to specify the PORT number of Wi-Fi module. Restart the printer is necessary.

### Syntax

**WLAN PORT** number

| <u>Parameter</u> | <u>Description</u>                     |
|------------------|--|
| number           | Base raw port number. Default is 9100. |

### Example

| <u>Sample code</u>   | <u>Result</u>  |
|--|--|
| <pre>WLAN SSID "TEST-AP"<br/>WLAN WPA "123456789"<br/>WLAN IP "10.0.10.138", "255.255.255.0", "10.0.10.252"<br/>WLAN PORT 8000<br/>SELFTEST WLAN</pre> | <pre>-----<br/>                        WLAN SETTING<br/>-----<br/>MAC ADDR: 001DC9-908397<br/>SSID: TEST-AP<br/>DHCP: OFF<br/>IP ADDR: 10.0.10.138<br/>SUBNET: 255.255.255.0<br/>GATEWAY: 10.0.10.252<br/>PORT: 8000<br/>-----</pre> |

# Internal Ethernet Setting Commands

## ● NET DHCP

### Description

This command is used to set the printer to get the IP address from DHCP server. Printer will restart itself while setting this command.

### Syntax

NET DHCP

### Example

| Sample code                           | Result   |
|---------------------------------------|--|
| <pre>NET DHCP SELFTEST ETHERNET</pre> | <pre>-----           ETHERNET SETTING -----           NAME : PS-600002           MAC ADDR : 001B82-600002           DHCP : ON           IP ADDR : 192.168.0.107           SUBNET : 255.255.255.0           GATEWAY : 192.168.0.1           PORT : 9100 -----</pre> |

### See Also

NET IP

## ● NET IP

### Description

This command is used to set the specific IP address to printer. Printer will restart itself while setting this command.

### Syntax

**NET IP "ip","mask","gateway"**

| <u>Parameter</u> | <u>Description</u> |
|------------------|--------------------|
| ip               | IP address         |
| mask             | Subnet mask        |
| gateway          | Default gateway    |

### Example

|  |
|--|
| <b>Sample code</b>   |
| <pre>NET IP "192.168.10.40","255.255.255.0","192.168.10.252"<br/>SELFTEST ETHERNET</pre>   |
| <b>Result</b>  |
| <pre>-----<br/>          ETHERNET SETTING<br/>-----<br/>      NAME : PS-600002<br/>      MAC ADDR : 001B82-600002<br/>      DHCP : OFF<br/>      IP ADDR : 192.168.10.40<br/>      SUBNET : 255.255.255.0<br/>      GATEWAY : 192.168.10.252<br/>      PORT : 9100<br/>-----</pre> |

### See Also

NET DHCP

## ● NET PORT

### Description

This command is used to specify the PORT number of Ethernet. Printer will restart itself while setting this command.

### Syntax

**NET PORT** number

| <u>Parameter</u> | <u>Description</u>                     |
|------------------|--|
| number           | Base raw port number. Default is 9100. |

### Example

| <u>Sample code</u>                         | <u>Result</u>   |
|--|---|
| <pre>NET PORT 9100 SELFTEST ETHERNET</pre> | <pre>-----                 ETHERNET SETTING ----- NAME : PS-600002 MAC ADDR: 001B82-600002 DHCP : OFF IP ADDR : 192.168.10.40 SUBNET : 255.255.255.0 GATEWAY : 192.168.10.252 PORT : 9100 -----</pre> |

## ● NET NAME

### Description

This command is used to set the printer server name.

### Syntax

**NET NAME "printerserver"**

| <u>Parameter</u> | <u>Description</u>                   |
|------------------|--------------------------------------|
| printerserver    | The specific name of printer server. |

### Example

| <u>Sample code</u>                           | <u>Result</u>   |
|--|---|
| <pre>NET NAME "TEST" SELFTEST ETHERNET</pre> | <pre>-----           ETHERNET SETTING ----- NAME : TEST MAC ADDR : 001B82-600002 DHCP : OFF IP ADDR : 192.168.10.40 SUBNET : 255.255.255.0 GATEWAY : 192.168.10.252 PORT : 9100 -----</pre> |

# NFC Setting Commands

## ● NFC FEATURE

### Description

This command is used to return information if the printer supports the optional NFC feature, and if it is currently installed.

(Supported device: Alpha-2R series)

### Syntax

#### NFC FEATURE

| <u>Parameter</u> | <u>Description</u> |
|------------------|--------------------|
| None             | N/A                |

| <u>Return Information</u> |  |
|---------------------------|--|
| not available             | NFC is not supported   |
| not present               | The feature is unavailable. NFC is supported, but no reader is installed |
| present                   | The feature is available. NFC is supported with a reader is installed    |

### Example

| <u>Sample code</u> | <u>Result</u>                              |
|--------------------|--|
| <b>NFC FEATURE</b> | Example by CommTool:<br><pre>present</pre> |

## ● NFC STATUS

### Description

This command is used to return current status of the NFC reader or status of last operation completed.

### Syntax

**NFC STATUS**

| <u>Parameter</u> | <u>Description</u> |
|------------------|--------------------|
| None             | N/A                |

| <u>Return Information</u> |   |
|---------------------------|---|
| Idle                      | The reader is inactive or hasn't been used    |
| in progress               | The operation is pending                      |
| timed out                 | The operation has timed out                   |
| successful                | The operation has been completed successfully |

### Example

| <u>Sample code</u> | <u>Result</u>                                  |
|--------------------|--|
| <b>NFC STATUS</b>  | Example by CommTool:<br><pre>in progress</pre> |

## ● NFC TIMEOUT

### Description

This command is used to set the timeout for the current read/write operation (in seconds) 0 to 3600, setting to 0 disables the timeout feature.

### Syntax

**NFC TIMEOUT m**

| <u>Parameter</u> | <u>Description</u> |
|------------------|--------------------|
| m                | 0 to 3600          |

**Note:**

- *The default value is 10 seconds when printer initializes.*
- *The printer will beep for notice when it's timeout.*

### Example

**Sample code**

```
NFC TIMEOUT 20
```



## ● NFC READ

### Description

This command is used to return content stored in the last NFC read event. (Max. of 2048 characters)

### Syntax

**NFC READ**

| <u>Parameter</u> | <u>Description</u> |
|------------------|--------------------|
| None             | N/A                |

### Example

**Sample code**

**NFC READ**

## ● NFC WRITE

### Description

This command is used to set the content to be transmitted by the NFC system. (Max. of 2048 characters)

### Syntax

**NFC WRITE "content"**

| <u>Parameter</u> | <u>Description</u>     |
|------------------|------------------------|
| content          | Content of text string |

### Example

#### Sample code

```
NFC WRITE "Test"
```

## ● NFC MODE

### Description

This command is used to set the NFC reader mode. This command can start or stop a read or write operation. (Max. of 2048 characters)

### Syntax

**NFC MODE OFF/READ/WRITE**

| <u>Parameter</u> | <u>Description</u> |
|------------------|--------------------|
| OFF              | Disable            |
| READ             | Read tag mode      |
| WRITE            | Write tag mode     |

**Note:**  
*The default value is "OFF". It returns to "OFF" after a read or write operation completes, fails or times out.  
For continue to write or read data to tag, set this value to the desired "READ" or "WRITE".*

### Example

#### Sample code

|  |  |
|--|--|
| <p><u>Write data to tag once</u></p> <p>NFC MODE OFF<br/>NFC TIMEOUT 3<br/>NFC WRITE "Test"</p> <p><u>Read data from tag once</u></p> <p>NFC MODE OFF<br/>NFC TIMEOUT 3<br/>NFC READ</p> | <p><u>Continue to write data to tag</u></p> <p>NFC MODE WRITE<br/>NFC WRITE "123456789"</p> <p><u>Continue to read data from Tag</u></p> <p>NFC MODE READ<br/>NFC READ</p> |
|--|--|

# Alpha-2R Setting Commands

## ● SET PRINTQUALITY

### Description

This command is used to set the print mode (print quality) for Alpha-2R series printer.  
(Supported device: Alpha-2R series only)

### Syntax

**SET PRINTQUALITY DRAFT/STANDARD/OPTIMUM**

| <u>Parameter</u> | <u>Description</u>  |
|------------------|---|
| DRAFT            | High print speed with lower density   |
| STANDARD         | Standard print speed and quality  |
| OPTIMUM          | According to the label content such as barcode, text, and graphic to lower the print speed for getting higher print quality |

**Note:**  
*The default value is "STANDARD".*

### Example

```
Sample code  
  
SET PRINTQUALITY DRAFT  
SET PRINTQUALITY STANDARD  
SET PRINTQUALITY OPTIMUM
```

## ● SET STANDBYTIME

### Description

This command is used to set the standby time for Alpha-2R series printer.  
(Supported device: Alpha-2R series only)

### Syntax

**SET STANDBYTIME OFF/XXXXX**

| <u>Parameter</u> | <u>Description</u> |
|------------------|--------------------|
| OFF              | Disable            |
| XXXXX            | 0 ~ 65534 (second) |

**Note:**

*The default value is "SET STANDBYTIME 120".*

### Example

**Sample code**

```
SET STANDBYTIME OFF  
SET STANDBYTIME 480
```

## ● SET SLEEPTIME

### Description

This command is used to set the sleeping time for Alpha-2R series printer.  
(Supported device: Alpha-2R series only)

### Syntax

**SET SLEEPTIME OFF/XXXXX**

| <u>Parameter</u> | <u>Description</u> |
|------------------|--------------------|
| OFF              | Disable            |
| XXXXX            | 0 ~ 65534 (minute) |

**Note:**

**The default value is "SET SLEEPTIME 30".**

### Example

**Sample code**

```
SET SLEEPTIME OFF  
SET SLEEPTIME 20
```

## ● GETSETTING\$()

### Description

This command is used to get the print mode (print quality) or standby time for Alpha-2R series printer.  
(Supported device: Alpha-2R series only)

### Syntax

GETSETTING\$("SYSTEM","INFORMATION","PRINTQUALITY")

GETSETTING\$("SYSTEM","INFORMATION","STANDBYTIME")

| <u>Parameter</u>          | <u>Description</u>         |
|---------------------------|----------------------------|
| None                      | N/A                        |
| <b>Return Information</b> |                            |
| <b>PRINTQUALITY</b>       | DRAFT, STANDARD or OPTIMUM |
| <b>STANDBYTIME</b>        | OFF or number              |

# GPIO Setting Commands

## ● SET GPO

### Description

Use this command to send out the GPIO signals by the printer.

### Syntax

**SET GPO** *n* **signal state, delay0, pulse0, delay1, pulse1, function condition**

| <u>Parameter</u>                                   | <u>Description</u>   |              |   |                     |  |                    |   |                       |   |                     |                            |                     |                           |                       |  |              |                           |                  |                         |             |                  |              |                      |
|--|--|--------------|---|---------------------|--|--------------------|---|-----------------------|---|---------------------|----------------------------|---------------------|---------------------------|-----------------------|--|--------------|---------------------------|------------------|-------------------------|-------------|------------------|--------------|----------------------|
| n  | n = 1 ~ 7<br>Seven dedicated outputs are available for the desired function conditions.  |              |   |                     |  |                    |   |                       |   |                     |                            |                     |                           |                       |  |              |                           |                  |                         |             |                  |              |                      |
| Signal state                                       | <table border="1"> <tr> <td><b>HIGH</b></td> <td>Goes the high level signal when the following function condition is detected.</td> </tr> <tr> <td><b>LOW</b></td> <td>Goes the low level signal when the following function condition is detected.</td> </tr> <tr> <td><b>POS</b></td> <td>Goes the positive pulse signal when the following function condition is detected.</td> </tr> <tr> <td><b>NEG</b></td> <td>Goes the negative pulse signal when the following function condition is detected.</td> </tr> </table>  | <b>HIGH</b>  | Goes the high level signal when the following function condition is detected. | <b>LOW</b>          | Goes the low level signal when the following function condition is detected. | <b>POS</b>         | Goes the positive pulse signal when the following function condition is detected. | <b>NEG</b>            | Goes the negative pulse signal when the following function condition is detected. |                     |                            |                     |                           |                       |  |              |                           |                  |                         |             |                  |              |                      |
| <b>HIGH</b>  | Goes the high level signal when the following function condition is detected.  |              |   |                     |  |                    |   |                       |   |                     |                            |                     |                           |                       |  |              |                           |                  |                         |             |                  |              |                      |
| <b>LOW</b>   | Goes the low level signal when the following function condition is detected.   |              |   |                     |  |                    |   |                       |   |                     |                            |                     |                           |                       |  |              |                           |                  |                         |             |                  |              |                      |
| <b>POS</b>   | Goes the positive pulse signal when the following function condition is detected.  |              |   |                     |  |                    |   |                       |   |                     |                            |                     |                           |                       |  |              |                           |                  |                         |             |                  |              |                      |
| <b>NEG</b>   | Goes the negative pulse signal when the following function condition is detected.  |              |   |                     |  |                    |   |                       |   |                     |                            |                     |                           |                       |  |              |                           |                  |                         |             |                  |              |                      |
| Delay0   | After detecting the following function condition, the printer will wait this period of time before sending out the “true” output signal.<br>Unit: millisecond. Maximum: 32000.   |              |   |                     |  |                    |   |                       |   |                     |                            |                     |                           |                       |  |              |                           |                  |                         |             |                  |              |                      |
| Pulse0   | Pulse width corresponding to the function condition becoming “true”.<br>(Ignored for level-type signals.)<br>Unit: millisecond. Maximum: 32000.  |              |   |                     |  |                    |   |                       |   |                     |                            |                     |                           |                       |  |              |                           |                  |                         |             |                  |              |                      |
| Delay1   | After detecting the following function condition, the printer will wait this period of time before sending out the “false” output signal.<br>Unit: millisecond. Maximum: 32000.  |              |   |                     |  |                    |   |                       |   |                     |                            |                     |                           |                       |  |              |                           |                  |                         |             |                  |              |                      |
| Pulse1   | Pulse width corresponding to the function condition becoming “false”.<br>(Ignored for level-type signals.)<br>Unit: millisecond. Maximum: 32000.   |              |   |                     |  |                    |   |                       |   |                     |                            |                     |                           |                       |  |              |                           |                  |                         |             |                  |              |                      |
| Function condition<br>(warning, error, control...) | <table border="1"> <tr> <td><b>FAULT</b></td> <td>Printer fault.</td> </tr> <tr> <td><b>FAULT RIBBON</b></td> <td>Ribbon error is occurred.</td> </tr> <tr> <td><b>FAULT PAPER</b></td> <td>Paper empty or paper jam is occurred.</td> </tr> <tr> <td><b>FAULT CARRIAGE</b></td> <td>Carriage is open.</td> </tr> <tr> <td><b>FAULT MEMORY</b></td> <td>Out of memory is occurred.</td> </tr> <tr> <td><b>FAULT CUTTER</b></td> <td>Cutter error is occurred.</td> </tr> <tr> <td><b>FAULT OVERHEAT</b></td> <td>Stepping motor or print head is over heat.</td> </tr> <tr> <td><b>PAUSE</b></td> <td>Pause status is occurred.</td> </tr> <tr> <td><b>TAKELABEL</b></td> <td>Take label is occurred.</td> </tr> <tr> <td><b>IDLE</b></td> <td>Printer is idle.</td> </tr> <tr> <td><b>PRINT</b></td> <td>Printer is printing.</td> </tr> </table> | <b>FAULT</b> | Printer fault.  | <b>FAULT RIBBON</b> | Ribbon error is occurred.  | <b>FAULT PAPER</b> | Paper empty or paper jam is occurred.   | <b>FAULT CARRIAGE</b> | Carriage is open.   | <b>FAULT MEMORY</b> | Out of memory is occurred. | <b>FAULT CUTTER</b> | Cutter error is occurred. | <b>FAULT OVERHEAT</b> | Stepping motor or print head is over heat. | <b>PAUSE</b> | Pause status is occurred. | <b>TAKELABEL</b> | Take label is occurred. | <b>IDLE</b> | Printer is idle. | <b>PRINT</b> | Printer is printing. |
| <b>FAULT</b>                                       | Printer fault.   |              |   |                     |  |                    |   |                       |   |                     |                            |                     |                           |                       |  |              |                           |                  |                         |             |                  |              |                      |
| <b>FAULT RIBBON</b>                                | Ribbon error is occurred.  |              |   |                     |  |                    |   |                       |   |                     |                            |                     |                           |                       |  |              |                           |                  |                         |             |                  |              |                      |
| <b>FAULT PAPER</b>                                 | Paper empty or paper jam is occurred.  |              |   |                     |  |                    |   |                       |   |                     |                            |                     |                           |                       |  |              |                           |                  |                         |             |                  |              |                      |
| <b>FAULT CARRIAGE</b>                              | Carriage is open.  |              |   |                     |  |                    |   |                       |   |                     |                            |                     |                           |                       |  |              |                           |                  |                         |             |                  |              |                      |
| <b>FAULT MEMORY</b>                                | Out of memory is occurred.   |              |   |                     |  |                    |   |                       |   |                     |                            |                     |                           |                       |  |              |                           |                  |                         |             |                  |              |                      |
| <b>FAULT CUTTER</b>                                | Cutter error is occurred.  |              |   |                     |  |                    |   |                       |   |                     |                            |                     |                           |                       |  |              |                           |                  |                         |             |                  |              |                      |
| <b>FAULT OVERHEAT</b>                              | Stepping motor or print head is over heat.   |              |   |                     |  |                    |   |                       |   |                     |                            |                     |                           |                       |  |              |                           |                  |                         |             |                  |              |                      |
| <b>PAUSE</b>                                       | Pause status is occurred.  |              |   |                     |  |                    |   |                       |   |                     |                            |                     |                           |                       |  |              |                           |                  |                         |             |                  |              |                      |
| <b>TAKELABEL</b>                                   | Take label is occurred.  |              |   |                     |  |                    |   |                       |   |                     |                            |                     |                           |                       |  |              |                           |                  |                         |             |                  |              |                      |
| <b>IDLE</b>  | Printer is idle.   |              |   |                     |  |                    |   |                       |   |                     |                            |                     |                           |                       |  |              |                           |                  |                         |             |                  |              |                      |
| <b>PRINT</b>                                       | Printer is printing.   |              |   |                     |  |                    |   |                       |   |                     |                            |                     |                           |                       |  |              |                           |                  |                         |             |                  |              |                      |



## Example

### Sample code

```
SET GPO1 HIGH,100,0,100,0,FAULT RIBBON  
SET GPO2 LOW,100,0,100,0,FAULT PAPER  
SET GPO3 POS,100,100,100,100,PAUSE  
SET GPO4 NEG,100,50,100,50,IDLE
```

## ● SET GPI

### Description

Use this command to receive the GPIO signals from external controlling devices.

### Syntax

**SET GPI**n signal, pulse, function

| <u>Parameter</u>   | <u>Description</u>  |              |   |                 |  |                  |   |              |   |                |  |            |                  |               |   |                   |   |                 |                         |                |   |
|--------------------|---|--------------|---|-----------------|--|------------------|---|--------------|---|----------------|--|------------|------------------|---------------|---|-------------------|---|-----------------|-------------------------|----------------|---|
| n                  | n = 1 ~ 4<br>Four dedicated inputs are available for the desired control functions.   |              |   |                 |  |                  |   |              |   |                |  |            |                  |               |   |                   |   |                 |                         |                |   |
| Signal state       | <table border="1"> <tr> <td><b>HIGH</b></td> <td>When a high level signal received, will activate the following printer control functions.</td> </tr> <tr> <td><b>LOW</b></td> <td>When a low level signal received, will activate the following printer control functions.</td> </tr> <tr> <td><b>POS</b></td> <td>When a positive pulse signal received, will activate the following printer control functions.</td> </tr> <tr> <td><b>NEG</b></td> <td>When a negative pulse signal received, will activate the following printer control functions.</td> </tr> </table>   | <b>HIGH</b>  | When a high level signal received, will activate the following printer control functions. | <b>LOW</b>      | When a low level signal received, will activate the following printer control functions. | <b>POS</b>       | When a positive pulse signal received, will activate the following printer control functions. | <b>NEG</b>   | When a negative pulse signal received, will activate the following printer control functions. |                |  |            |                  |               |   |                   |   |                 |                         |                |   |
| <b>HIGH</b>        | When a high level signal received, will activate the following printer control functions.   |              |   |                 |  |                  |   |              |   |                |  |            |                  |               |   |                   |   |                 |                         |                |   |
| <b>LOW</b>         | When a low level signal received, will activate the following printer control functions.  |              |   |                 |  |                  |   |              |   |                |  |            |                  |               |   |                   |   |                 |                         |                |   |
| <b>POS</b>         | When a positive pulse signal received, will activate the following printer control functions.   |              |   |                 |  |                  |   |              |   |                |  |            |                  |               |   |                   |   |                 |                         |                |   |
| <b>NEG</b>         | When a negative pulse signal received, will activate the following printer control functions.   |              |   |                 |  |                  |   |              |   |                |  |            |                  |               |   |                   |   |                 |                         |                |   |
| Pulse              | Filter pulse width. Ignored for level-type signals.<br>Unit: millisecond. Maximum: 32000.   |              |   |                 |  |                  |   |              |   |                |  |            |                  |               |   |                   |   |                 |                         |                |   |
| Function (control) | <table border="1"> <tr> <td><b>PAUSE</b></td> <td>Toggle pause status.</td> </tr> <tr> <td><b>PAUSE ON</b></td> <td>Enter pause status.</td> </tr> <tr> <td><b>PAUSE OFF</b></td> <td>Cancel pause status.</td> </tr> <tr> <td><b>PRINT</b></td> <td>Print batch of labels.</td> </tr> <tr> <td><b>PRINT n</b></td> <td>n is numerical. Specify how many labels to print.<br/>Maximum: 32000.</td> </tr> <tr> <td><b>CUT</b></td> <td>Cut immediately.</td> </tr> <tr> <td><b>FEED n</b></td> <td>n is numerical and the unit is dot. Specify the feeding length. Maximum: 32000.</td> </tr> <tr> <td><b>BACKFEED n</b></td> <td>n is numerical and the unit is dot. Specify the backfeeding length. Maximum: 32000.</td> </tr> <tr> <td><b>FORMFEED</b></td> <td>Feeding an empty label.</td> </tr> <tr> <td><b>INPUT n</b></td> <td>n is text or command. The n will be triggered to printer.</td> </tr> </table> | <b>PAUSE</b> | Toggle pause status.  | <b>PAUSE ON</b> | Enter pause status.  | <b>PAUSE OFF</b> | Cancel pause status.  | <b>PRINT</b> | Print batch of labels.  | <b>PRINT n</b> | n is numerical. Specify how many labels to print.<br>Maximum: 32000. | <b>CUT</b> | Cut immediately. | <b>FEED n</b> | n is numerical and the unit is dot. Specify the feeding length. Maximum: 32000. | <b>BACKFEED n</b> | n is numerical and the unit is dot. Specify the backfeeding length. Maximum: 32000. | <b>FORMFEED</b> | Feeding an empty label. | <b>INPUT n</b> | n is text or command. The n will be triggered to printer. |
| <b>PAUSE</b>       | Toggle pause status.  |              |   |                 |  |                  |   |              |   |                |  |            |                  |               |   |                   |   |                 |                         |                |   |
| <b>PAUSE ON</b>    | Enter pause status.   |              |   |                 |  |                  |   |              |   |                |  |            |                  |               |   |                   |   |                 |                         |                |   |
| <b>PAUSE OFF</b>   | Cancel pause status.  |              |   |                 |  |                  |   |              |   |                |  |            |                  |               |   |                   |   |                 |                         |                |   |
| <b>PRINT</b>       | Print batch of labels.  |              |   |                 |  |                  |   |              |   |                |  |            |                  |               |   |                   |   |                 |                         |                |   |
| <b>PRINT n</b>     | n is numerical. Specify how many labels to print.<br>Maximum: 32000.  |              |   |                 |  |                  |   |              |   |                |  |            |                  |               |   |                   |   |                 |                         |                |   |
| <b>CUT</b>         | Cut immediately.  |              |   |                 |  |                  |   |              |   |                |  |            |                  |               |   |                   |   |                 |                         |                |   |
| <b>FEED n</b>      | n is numerical and the unit is dot. Specify the feeding length. Maximum: 32000.   |              |   |                 |  |                  |   |              |   |                |  |            |                  |               |   |                   |   |                 |                         |                |   |
| <b>BACKFEED n</b>  | n is numerical and the unit is dot. Specify the backfeeding length. Maximum: 32000.   |              |   |                 |  |                  |   |              |   |                |  |            |                  |               |   |                   |   |                 |                         |                |   |
| <b>FORMFEED</b>    | Feeding an empty label.   |              |   |                 |  |                  |   |              |   |                |  |            |                  |               |   |                   |   |                 |                         |                |   |
| <b>INPUT n</b>     | n is text or command. The n will be triggered to printer.   |              |   |                 |  |                  |   |              |   |                |  |            |                  |               |   |                   |   |                 |                         |                |   |

### Example

#### Sample code

```
SET GPI1 HIGH,0,PAUSE
SET GPI2 LOW,0,PAUSE ON
SET GPI3 POS,100,PAUSE OFF
SET GPI4 NEG,100,CUT
```

```
SET GPI1 NEG,100,INPUT "TEST.BAS"+CHR$(13)+CHR$(10)
```

## GPIO Waveform

**GPI Level Signal : Continuous action. (Host to printer.)**

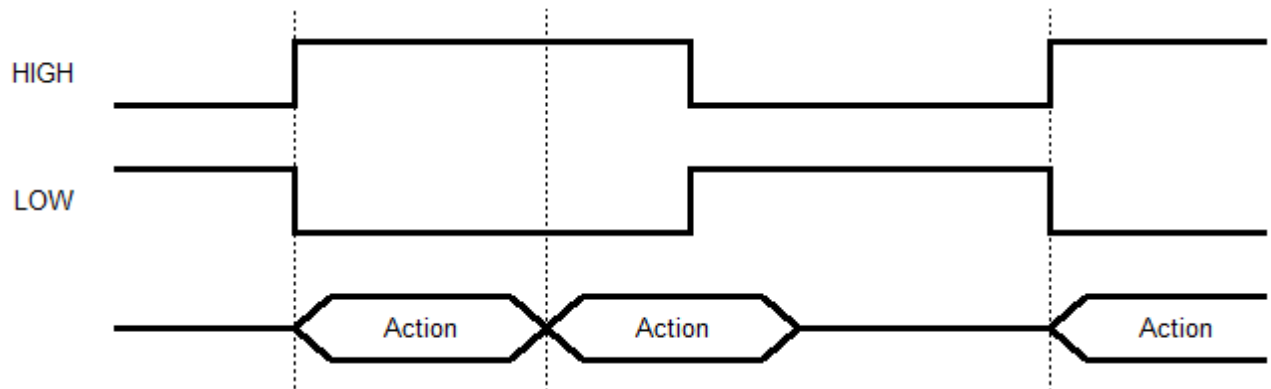

**GPI Pulse Signal : A pulse is an action. (Host to printer.)**

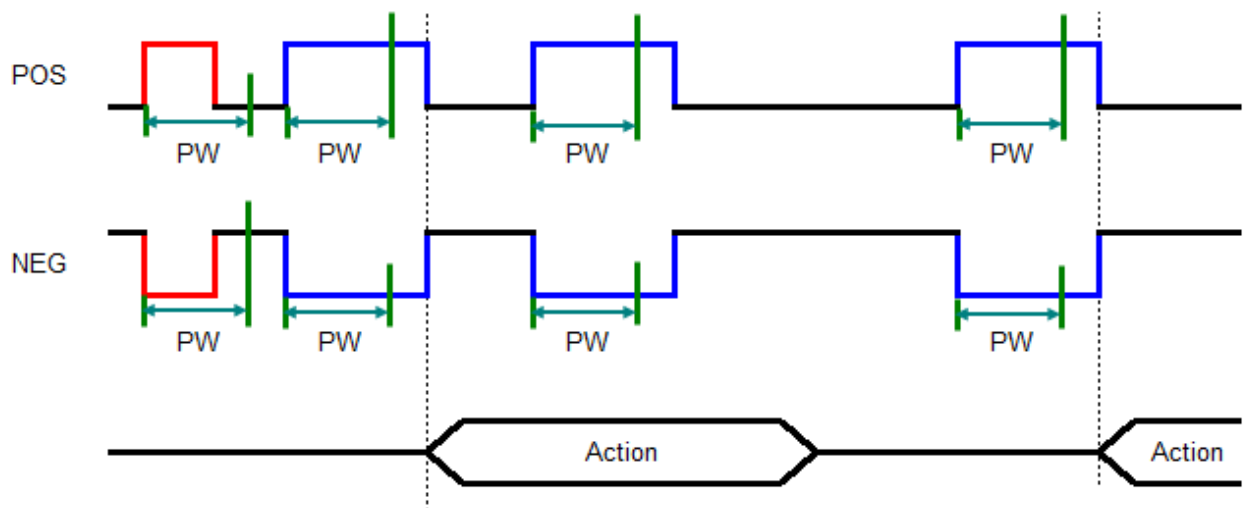

**GPO Level Signal : Continuous condition. (Printer to host.)**

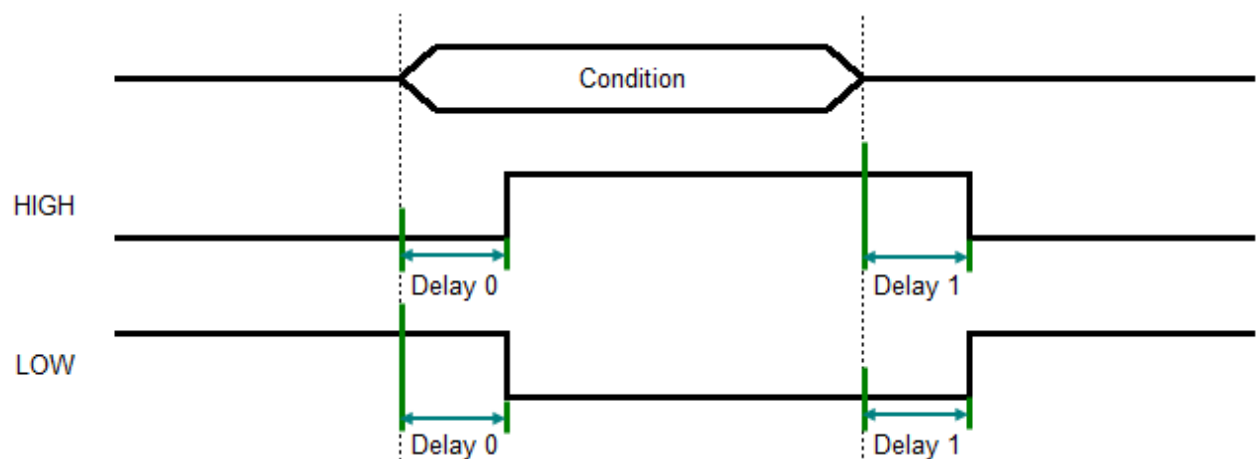

**GPO Pulse Signal : A pulse is a condition. (Printer to host.)**

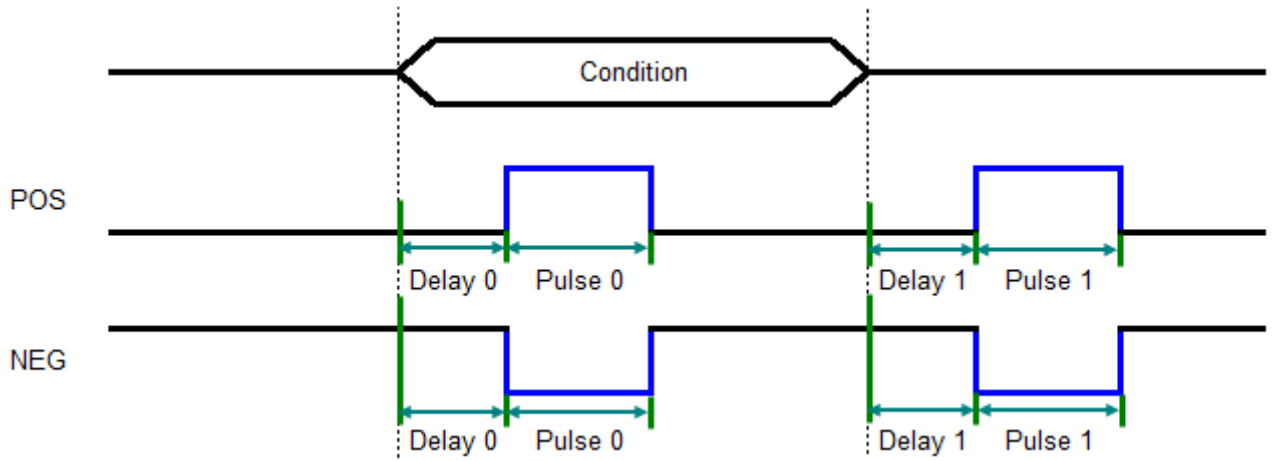

# GPIO Interface (HD15F) Circuit Diagram [TTP-2410MT/ MXP/ MH series]

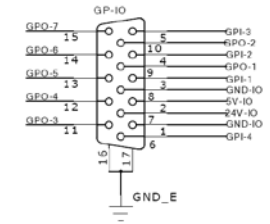
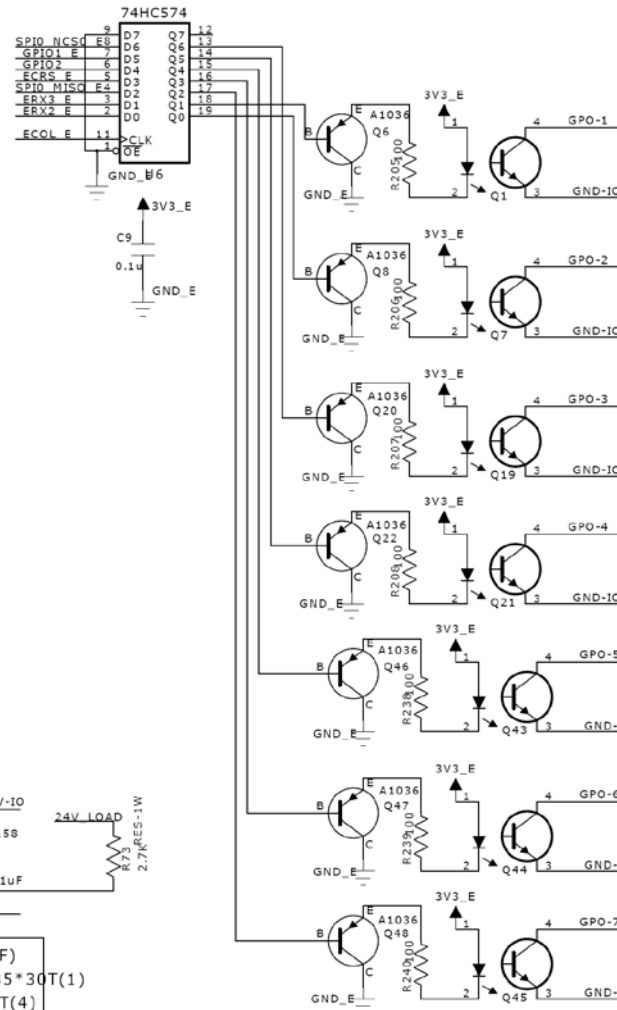
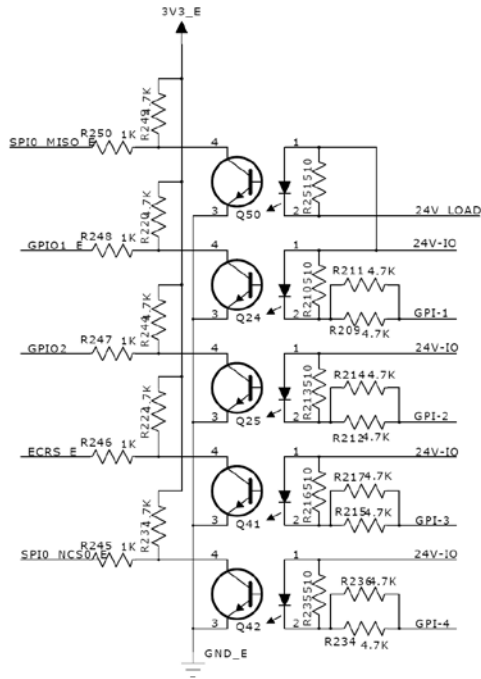

TTP-2410MT/ MXP/ MH series

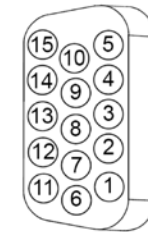

| PIN No. | Signal Name |
|---------|-------------|
| 1       | GND-IO      |
| 2       | 5V-IO       |
| 3       | GPI-1       |
| 4       | GPI-2       |
| 5       | GPI-3       |
| 6       | GPI-4       |
| 7       | 24V-IO      |
| 8       | GND-IO      |
| 9       | GPO-1       |
| 10      | GPO-2       |
| 11      | GPO-3       |
| 12      | GPO-4       |
| 13      | GPO-5       |
| 14      | GPO-6       |
| 15      | GPO-7       |

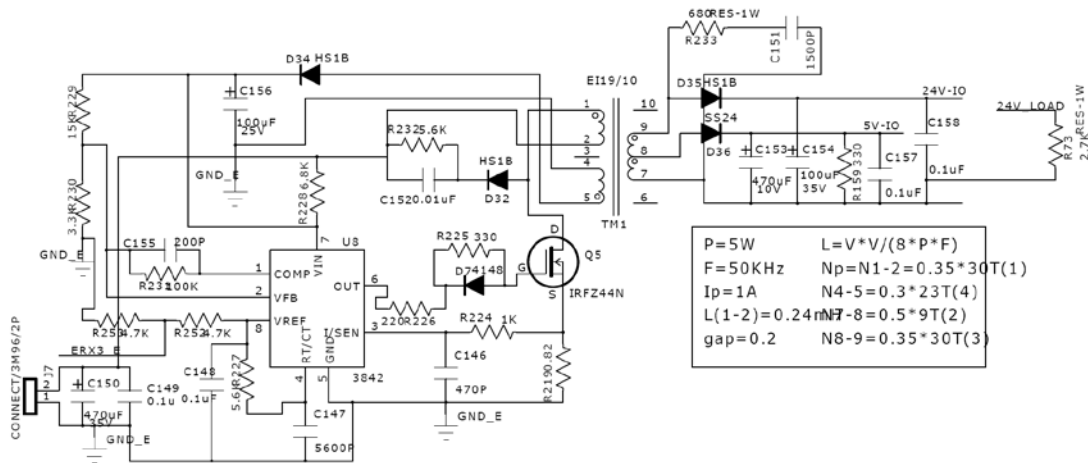

$P=5W$        $L=V^*/(8*P*F)$   
 $F=50KHz$      $Np=N1-2=0.35*30T(1)$   
 $Ip=1A$        $N4-5=0.3*23T(4)$   
 $L(1-2)=0.24mH$      $N7-8=0.5*9T(2)$   
 $gap=0.2$        $N8-9=0.35*30T(3)$

TTP-384M series

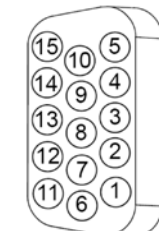

| PIN No. | Signal Name |
|---------|-------------|
| 1       | GND-IO      |
| 2       | 5V-IO       |
| 3       | GPI-1       |
| 4       | GPI-2       |
| 5       | N/A         |
| 6       | N/A         |
| 7       | 24V-IO      |
| 8       | GND-IO      |
| 9       | N/A         |
| 10      | N/A         |
| 11      | N/A         |
| 12      | GPO-4       |
| 13      | GPO-5       |
| 14      | N/A         |
| 15      | GPO-7       |

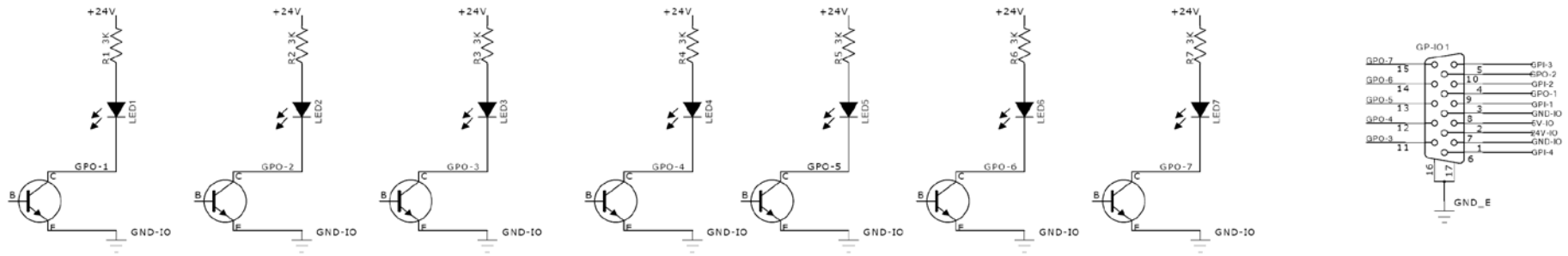

**GPO pin no. 1~7 application example:**

Since we connect GPO pin no. 1~7 with seven individual LED, the output signal from GPO will light the individual LED on or off.

\*NPN output specification.

|                                |           |            |
|--------------------------------|-----------|------------|
| Collector-emitter voltage      | $V_{CEO}$ | 35 V       |
| Emitter-collector voltage      | $V_{CEO}$ | 6 V        |
| Collector current              | $I_C$     | Max. 50 mA |
| *1 Collector power dissipation | $P_C$     | 150 mW     |

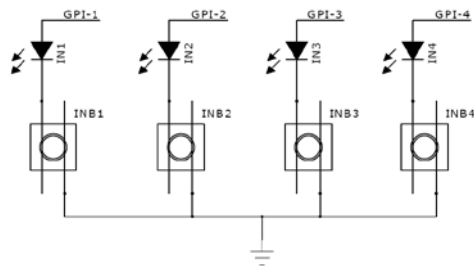

**GPI pin no. 1~4 application example:**

Since we connect GPI pin no. 1~4 with four individual button keys to control the desired printer functions. The input signal current suggests 20 mA.

# ● Applicator I/O Interface (DB15F) Circuit Diagram [PEX-1000 series]

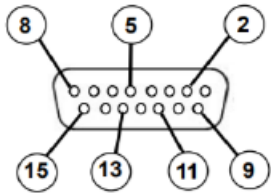
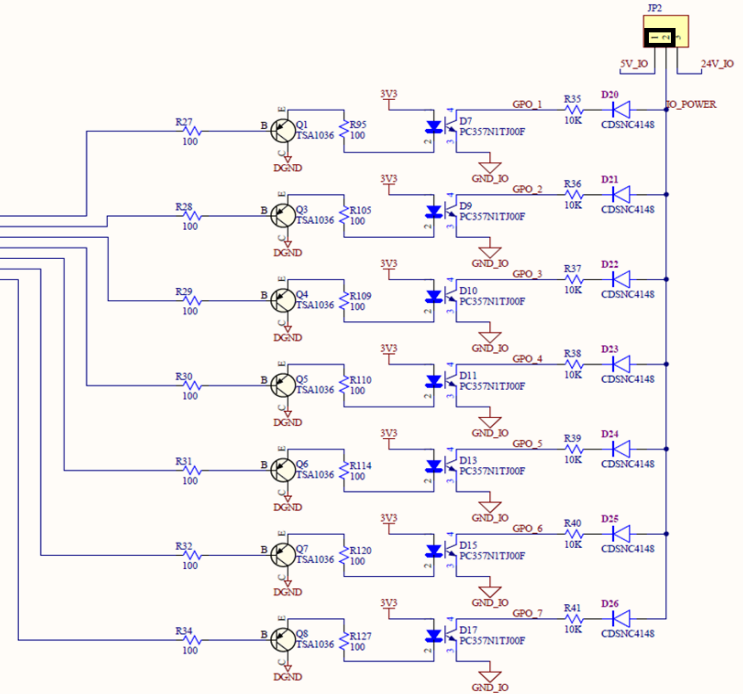
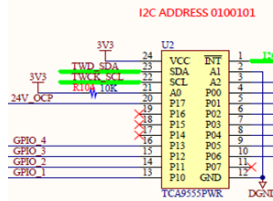
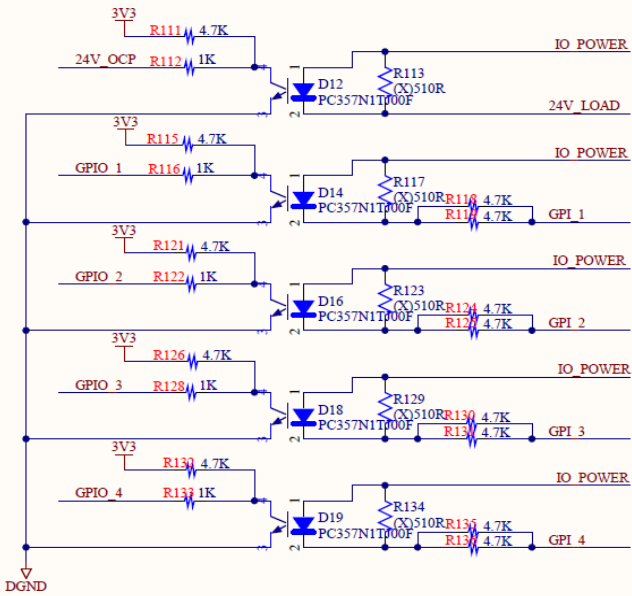

Female Connector Front View

PEX-1000 series

| PIN | CONFIGURATION | SIGNAL NAME       | SIGNAL TYPE       |
|-----|---------------|-------------------|-------------------|
| 1   | GND           | I/O SIGNAL GROUND | I/O Signal Ground |
| 2   | 5V(JP2 short) | I/O SIGNAL POWER  | Power             |
| 3   | GPI_1         | PRINT START       | Input             |
| 4   | GPI_2         | FORMFEED          | Input             |
| 5   | GPI_3         | PAUSE             | Input             |
| 6   | GPI_4         | REPRINT           | Input             |
| 7   | 24V           | (+) 24V           | Power             |
| 8   | GND           | GROUND            | Power Ground      |
| 9   | GPO_1         | LOWRIBBON         | Output            |
| 10  | GPO_2         | FAULT             | Output            |
| 11  | GPO_3         | PRINT END         | Output            |
| 12  | GPO_4         | FAULT PAPER       | Output            |
| 13  | GPO_5         | FAULT RIBBON      | Output            |
| 14  | GPO_6         | DATA READY        | Output            |
| 15  | GPO_7         | Dummy             | Output            |

# Update History

| Date       | Content  | Editor  |
|------------|--|---------|
| 2007/07/13 | Revise some typos  | Phil    |
| 2007/12/25 | Revise FREAD\$( ) example  | Camille |
| 2008/04/10 | Add update history list  | Camille |
| 2009/01/17 | Add GAPDETECT command  | Ken     |
| 2009/05/18 | Add CIRCLE command   | Phil    |
| 2009/06/24 | Add RSS command  | Phil    |
| 2010/07/06 | Revise bar command section   | Camille |
| 2010/10/25 | Revise some sections   | Camille |
| 2011/01/06 | Add CODE 11 barcode  | Ernest  |
| 2011/01/06 | Add AZTEC barcode  | Ernest  |
| 2011/01/06 | Revise sensor intension table in SET GAP command   | Ernest  |
| 2011/01/10 | Add BLINEDETECT command  | Ernest  |
| 2011/01/10 | Add AUTODETECT command   | Ernest  |
| 2011/01/10 | Add BASIC function FORMAT\$( )   | Ernest  |
| 2011/01/10 | Add BASIC function NOW\$( )  | Ernest  |
| 2011/01/10 | Add BASIC function TRIM\$( )   | Ernest  |
| 2011/01/10 | Add BASIC function LTRIM\$( )  | Ernest  |
| 2011/01/10 | Add BASIC function RTRIM\$( )  | Ernest  |
| 2010/01/10 | Add BASIC function STRCOMP( )  | Ernest  |
| 2010/01/10 | Add BASIC function INSTR( )  | Ernest  |
| 2011/01/25 | Modify TSC address   | Camille |
| 2011/03/04 | Revise, TTP-248M doesn't support mirror function   | Ernest  |
| 2011/03/04 | Add sensor range of TTP-225/ TDP-225 in command SET GAP                                  | Ernest  |
| 2011/12/09 | Add some command spec in RSS barcode.  | Ernest  |
| 2012/11/20 | Add command SET USBHOST KEYBOARD/SCANNER   | Ernest  |
| 2012/11/20 | Revise STRCOMP( ) example  | Ernest  |
| 2012/11/20 | Revise TRIM\$( ), LTRIM\$( ), RTRIM\$( ) example.  | Ernest  |
| 2012/11/20 | Add <ESC>!P command.   | Ernest  |
| 2012/11/20 | Add <ESC>!O command.   | Ernest  |
| 2012/11/20 | Revise OUT command.  | Ernest  |
| 2012/11/20 | Add SET BLINE command.   | Ernest  |
| 2012/11/20 | Add ELLIPSE command.   | Ernest  |
| 2012/11/20 | Add SET RIBBONEND command.   | Ernest  |
| 2012/11/20 | Add SET ENCODER command.   | Ernest  |
| 2012/11/21 | Revise TEXT command.   | Ernest  |
| 2012/11/21 | Revise speed table of SPEED command.   | Ernest  |
| 2012/11/21 | Revise AZTEC command.  | Ernest  |
| 2012/11/21 | Add BLOCK command.   | Ernest  |
| 2012/11/21 | Add PUT command.   | Ernest  |
| 2012/11/21 | Add GET command.   | Ernest  |
| 2012/11/21 | Add INP( ) command.  | Ernest  |
| 2012/11/22 | Revise PUTBMP command. Support grayscale printing in direct thermal printing.            | Ernest  |
| 2012/11/22 | Revise BARCODE command. New support barcode TELEPEN, TELEPENN, PLANET, CODE49, DPI, DPL. | Ernest  |
| 2012/11/23 | Add TLC39 barcode.   | Ernest  |
| 2012/11/23 | Add CODABLOCK command (F mode only).   | Ernest  |
| 2012/11/23 | Add SELFTEST PATTERN command.  | Ernest  |
| 2012/11/23 | Revise the supported CODEPAGE table and example.   | Ernest  |
| 2012/11/23 | Add global variable NOW.   | Ernest  |
| 2012/11/26 | Add DATEADD( ) command.  | Ernest  |
| 2012/11/26 | Add SET AUTORUN command.   | Ernest  |
| 2012/11/26 | Add LOC( ) command.  | Ernest  |
| 2012/11/26 | Add NOW\$( ) command.  | Ernest  |
| 2012/11/26 | Revise SET RIBBON command.   | Ernest  |
| 2012/11/26 | Revise SET COUNTER command.  | Ernest  |
| 2012/11/26 | Add <ESC>!C command.   | Ernest  |
| 2012/11/26 | Add <ESC>!Q command.   | Ernest  |
| 2012/11/26 | Add <ESC>!S command.   | Ernest  |
| 2012/11/26 | Add OUTR command.  | Ernest  |
| 2012/11/26 | Add <ESC>!D command.   | Ernest  |
| 2012/11/26 | Add ~!E command.   | Ernest  |
| 2012/11/27 | Add LOB( ) command.  | Ernest  |
| 2012/11/27 | Add WHILE ... WEND command.  | Ernest  |
| 2012/11/27 | Add DO ... LOOP command.   | Ernest  |



|            |  |         |
|------------|--|---------|
| 2012/11/27 | Add TEXTPIXEL() command.   | Ernest  |
| 2012/11/27 | Add BARCODEPIXEL() command.  | Ernest  |
| 2012/11/27 | Add GETSENSOR() command.   | Ernest  |
| 2012/11/27 | Add GETSETTING() command.  | Ernest  |
| 2012/11/28 | Revise SET CUTTER command.   | Ernest  |
| 2012/11/28 | Revise OPEN command.   | Ernest  |
| 2012/11/28 | Revise FOR ... NEXT LOOP command.                                      | Ernest  |
| 2012/11/28 | Add CLOSE command.   | Ernest  |
| 2012/11/28 | Add COPY command.  | Ernest  |
| 2012/11/28 | Add MPDF417 command for Micro PDF 417 barcode.                         | Ernest  |
| 2012/11/30 | Add EOJ command.   | Ernest  |
| 2012/11/30 | Add DELAY command.   | Ernest  |
| 2012/11/30 | Add DISPLAY command.   | Ernest  |
| 2012/11/30 | Add XOR\$() command.   | Ernest  |
| 2012/11/30 | Add _MODEL\$ variable.   | Ernest  |
| 2012/11/30 | Add _SERIAL\$ variable.  | Ernest  |
| 2012/11/30 | Add _VERSION\$ variable.   | Ernest  |
| 2012/11/30 | Revise LIMITFEED command.  | Ernest  |
| 2012/11/30 | Revise BOX command.  | Ernest  |
| 2012/11/30 | Add SET FEED_LEN command.  | Ernest  |
| 2012/12/20 | Add external Wi-Fi module setting commands.                            | Ernest  |
| 2012/12/20 | Add Ethernet setting commands.   | Ernest  |
| 2012/12/24 | Revise DMATRIX command.  | Ernest  |
| 2012/12/24 | Revise LIMITFEED command.  | Ernest  |
| 2012/12/24 | Revise SELFTEST command  | Camille |
| 2013/2/5   | Add sample result for each section                                     | Camille |
| 2013/2/6   | Add CODEPAGE 864 (Arabic) ; since F/W V7.0                             | Camille |
| 2013/2/26  | Add <ESC>!F command.   | Camille |
| 2013/2/26  | Add <ESC>! . Command.  | Camille |
| 2013/6/25  | Modify sample code for PUTPCX command                                  | Camille |
| 2013/12/13 | Modify GAP and BLINE command   | Camille |
| 2014/1/22  | Add INITIALPRINTER command   | Camille |
| 2014/3/28  | Modify sample code for SET COUNTER command                             | Samuel  |
| 2014/4/15  | Add GPIO setting commands  | Camille |
| 2014/6/11  | Modify SPEED section   | Camille |
| 2014/6/12  | Modify BACKFEED & BACKUP section                                       | Camille |
| 2014/6/12  | Modify DIRECTION section   | Camille |
| 2014/6/12  | Modify SHIFT section   | Camille |
| 2014/6/12  | Modify HOME section  | Camille |
| 2014/6/12  | Modify BARCODE section   | Camille |
| 2014/6/12  | Modify PUTBMP section  | Camille |
| 2014/6/12  | Modify PUTPCX section  | Camille |
| 2014/6/12  | Modify QRCODE section  | Camille |
| 2014/6/12  | Modify TEXT section  | Camille |
| 2014/6/12  | Modify ~!T section   | Camille |
| 2014/6/12  | Modify DOWNLOAD section  | Camille |
| 2014/6/12  | Modify KILL section  | Camille |
| 2014/6/12  | Modify RUN section   | Camille |
| 2014/6/13  | Add <ESC> Y command  | Camille |
| 2014/6/13  | Add <ESC> Z command  | Camille |
| 2014/6/13  | Modify IF...THEN...ELSE...ENDIF LOOP section                           | Camille |
| 2014/6/13  | Modify GETKEY() section  | Camille |
| 2014/6/13  | Modify SET PARTIAL_CUTTER section                                      | Camille |
| 2014/6/17  | Modify SET BACK section  | Camille |
| 2014/6/18  | Modify SET KEY1, SET KEY2, SET KEY3 section                            | Camille |
| 2014/6/18  | Modify TEAR & SETSTRIPER section                                       | Camille |
| 2014/6/18  | Modify SET HEAD section  | Camille |
| 2014/6/18  | Modify SET PRINTKEY section  | Camille |
| 2014/6/18  | Modify SET REPRINT section   | Camille |
| 2014/6/18  | Modify KEY1, KEY2, KEY3 section  | Camille |
| 2014/6/18  | Modify @YEAR, @MONTH, @DATE, @DAY, @HOUR, @MINUTE and @SECOND sections | Camille |
| 2014/6/19  | Modify SET LED1, SET LED2, SET LED3 section                            | Camille |
| 2014/6/19  | Modify LED1, LED2, LED3 section  | Camille |
| 2014/6/19  | Modify SET GAP section   | Camille |
| 2014/6/20  | Modify printer model list  | Camille |
| 2014/8/1   | Modify GPO example   | Camille |

|            |   |         |
|------------|---|---------|
| 2014/10/14 | Modify GPO function (Add PRINT)   | Camille |
| 2014/11/28 | Modify printer model list   | Camille |
| 2014/11/28 | Add SET REWIND section  | Camille |
| 2015/3/11  | Modify printer model list   | Camille |
| 2015/4/10  | Modify SPEED section  | Camille |
| 2015/5/11  | Modify <ESC>IS command section (Add Print head error)   | Camille |
| 2015/5/15  | Revise OFFSET command section   | Camille |
| 2015/9/11  | Revise GETSETTING\$() section   | Camille |
| 2015/10/29 | Modify SHIFT section<br>Modify SET KEY section<br>Modify PUTBMO section<br>Add SET RESPONSE section | Camille |
| 2015/10/30 | Modify GPIO section   | Camille |
| 2015/11/18 | Add DIAGONAL command<br>Modify SET USBHOST section  | Camille |
| 2015/11/19 | Modify DISPLAY section  | Camille |
| 2015/11/24 | Add FSEARCH() command<br>Add SET VERIFIER command   | Camille |
| 2015/11/25 | Add TOUCHPRESS() command  | Camille |
| 2015/12/8  | Modify DMATRIX section (add a# parameter)   | Camille |
| 2015/12/17 | Add SET RS232_REWINDER command  | Camille |
| 2016/2/4   | Add RECORDSET\$() command   | Camille |
| 2016/4/11  | Add FNC sample code on DMATRIX section  | Camille |
| 2016/7/11  | Modify SET KEYn section   | Camille |
| 2016/7/11  | Update printer model list   | Camille |
| 2016/9/26  | Update GETSETTING\$() section   | Camille |
| 2017/1/18  | Add SET DAYLIGHT_SAVE command   | Camille |
| 2017/1/18  | Add rectangular shape sample code on DMATRIX section  | Camille |
| 2017/1/18  | Add LABELRATIO command  | Camille |
| 2017/2/15  | Add NFC setting Command section   | Camille |
| 2017/3/8   | Modify BLOCK section  | Camille |
| 2017/4/5   | Modify SET KEYn section   | Camille |
| 2017/4/5   | Modify KEY1, SET KEY2, SET KEY3 section   | Camille |
| 2017/4/5   | Update printer model list   | Camille |
| 2017/4/5   | Modify SPEED section  | Camille |
| 2017/4/6   | Modify SET LEDn section   | Camille |
| 2017/4/6   | Modify LED1, LED2, LED3 section   | Camille |
| 2017/4/11  | Modify KEY1, SET KEY2, SET KEY3 section   | Camille |
| 2017/4/14  | Add smart phone data string on QRCODE section   | Camille |
| 2017/4/17  | Modify FORMAT\$ ( ) section (sample code)   | Camille |
| 2017/5/16  | Add setting command section for Alpha-2R  | Camille |
| 2017/6/7   | Add new parameters for QRCODE command   | Camille |
| 2017/6/8   | Add MENU command  | Camille |
| 2017/6/8   | Add sample code for [fit] parameter on BLOCK section  | Camille |
| 2017/6/8   | Add sample code for (") on RECORDSET\$ ( ) section  | Camille |
| 2017/7/21  | Add EAN128M to BARCODE section  | Camille |
| 2017/8/17  | Add new parameters for SET REWIND command   | Camille |
| 2017/9/15  | Add new parameters & examples for FORMAT\$ ( ) command  | Camille |
| 2017/10/16 | Add the standard symbol sizes for DataMatrix 2D barcode on DMATRIX section                          | Camille |
| 2017/10/23 | - Modify the <ESC>IS section (#2: warning)<br>- Add a parameter for SET GPI command                 | Camille |
| 2017/11/22 | Remove WLAN MODE (Ad-hoc)   | Camille |
| 2018/1/19  | Update GPIO info.   | Camille |
| 2018/2/6   | Add a sample for RSS command  | Camille |
| 2018/2/7   | Add the new parameter for GETSETTING command  | Camille |
| 2018/2/12  | Add the QRcode sample code for smart phone data string  | Camille |
| 2018/2/13  | Modify a parameter for SET GPI command  | Camille |
| 2018/3/1   | Update FORMAT\$ ( ) section   | Camille |
| 2018/5/17  | Update the sample Code 1 for RECORDSET\$ ( ) section  | Camille |
| 2018/7/13  | Add parameters(25S/25I) for BARCODE command   | Camille |
| 2018/8/6   | Modify the SIZE section ("n" can be an optional item)   | Camille |
| 2018/9/14  | Add DNS parameter for GETSETTING\$() command  | Camille |
| 2018/9/25  | Modify <ESC>ID section  | Camille |
| 2018/10/9  | Add battery parameters and sample code on GETSENSOR() command section                               | Camille |
| 2018/10/30 | Add the note for example on <ESC>IS section   | Camille |
| 2018/11/20 | Modify SET RS232_REWINDER section   | Camille |
| 2018/12/20 | Modify sample for SET GPI section   | Camille |

|            |  |         |
|------------|--|---------|
| 2018/12/20 | Add the parameter "BT" for SELFTTEST section                     | Camille |
| 2018/12/20 | Add the Bluetooth module setting commands                        | Camille |
| 2019/1/9   | Add applicator I/O interface (DB15F) circuit diagram information | Camille |
| 2019/3/12  | Add REPLACE\$( ) command   | Camille |
| 2019/3/26  | Add ML/ MB series models on SET KEYn section                     | Camille |
| 2019/3/26  | Modify printer model list  | Camille |
| 2019/3/29  | Modify GPIO info for PEX   | Camille |
| 2019/4/17  | Add SET SLEEPTIME command  | Camille |



**TSC Auto ID Technology Co., Ltd.**

Corporate Headquarters

9F., No.95, Minquan Rd., Xindian Dist.,  
New Taipei City 23141, Taiwan (R.O.C.)

TEL: +886-2-2218-6789

FAX: +886-2-2218-5678

Web site: [www.tscprinters.com](http://www.tscprinters.com)

E-mail: [printer\\_sales@tscprinters.com](mailto:printer_sales@tscprinters.com)

[tech\\_support@tscprinters.com](mailto:tech_support@tscprinters.com)

Li Ze Plant

No.35, Sec. 2, Ligong 1st Rd., Wujie Township,  
Yilan County 26841, Taiwan (R.O.C.)

TEL: +886-3-990-6677

FAX: +886-3-990-5577